

## **Welcome to DesignCAD 97 For Windows 95**

[Read Me First](#)

[Introduction](#)

[Typographical Conventions](#)

[System Requirements](#)

[Technical Support](#)

## **Using DesignCAD 97 For Windows 95**

[The DesignCAD 97 Drawing Screen](#)

[Accessing Commands](#)

[Moving Around, Setting Points, And More](#)

## **DesignCAD 97 For Windows 95 Reference**

[DesignCAD 97 for Windows 95 Command Reference](#)

[BasicCAD for DesignCAD 97](#)

[DesignCAD 97 Command List](#)

[DesignCAD 97 Parameters](#)

[Hatch Patterns](#)

[Defining Your Own Hatch Pattern](#)

[Sample Digitizer Menu](#)

[Installing Fonts](#)

[OLE Automation Functions](#)

[\*\*DesignCAD 97 Order Form\*\*](#)

Thank you for purchasing DesignCAD 97 for Windows 95. DesignCAD is a powerful but inexpensive 2-D and 3-D CAD system that puts tremendous drafting power into the hands of both professional and casual users. It has all the features professionals need, yet casual users find it easy to operate.

This help file provides you with complete information about each command in DesignCAD 97. The information is arranged alphabetically for easy access.

If you want to automate some of your frequent DesignCAD drawing tasks, refer to the "BasicCAD for DesignCAD 97" section. It offers complete details on the BasicCAD programming language.

To use DesignCAD 97 for Windows 95, you must have, **at a minimum**, the following hardware and software installed in your computer:

- 10 megabytes of available hard drive space.
- Microsoft Windows 95 or NT 4.0.

Although not required for running DesignCAD 97 for Windows 95, the following hardware is recommended for better performance:

- 486DX or Pentium processor.
- at least 16 megabytes of RAM.
- SuperVGA graphics card capable of 256 or more colors.
- SuperVGA monitor capable of at least 800x600 resolution.

This help file uses a few special symbols to refer to commands and instructions.

### Mouse

- When the word "click" is used alone, it means "left-click," or to press the left mouse button. When it is necessary to use the right mouse button, the Help file states that explicitly.

### Keyboard

- The keys on your keyboard may not be labeled exactly as they are in this Help file. All key names are shown using bold, sans serif type. For example, the "Control" key is shown as **Ctrl** and the "Enter" key is shown as **Enter**.
- Keys are sometimes used in combinations. For example, **Ctrl+F** means to hold down the **Ctrl** key while pressing the **F** key.
- "Arrow keys" is the collective name for the up arrow, down arrow, left arrow, and right arrow keys.
- To choose a command from a menu, you can use the mouse or press a key combination.

### Instructions

- Specific text or numbers you must type are shown in bold, sans serif type. For example, if you are instructed to enter **13**, you type "13." Then press **Enter**.
- Placeholders for items that you must supply yourself, such as file names, are italicized. When the Help file says to enter "**CD** *directoryname*," for example, you type "CD" followed by a space and the name of the directory.
- Menu items, settings, and various options and Command Line boxes that you are to select or use appear in non-serif type, in small capital letters. For example, "Choose the PRINT command from the FILE menu" means that you should click on the "File" menu, move the cursor down to "Print" and click again.
- At times you will be instructed to choose commands located in submenus in the Command Menu. The sequence may be indicated with a "pipe," or vertical bar. "Select DRAW|ARC|ARC (CENTER, BEGIN, END) means to select the Arc (Center, Begin, End) command, which is located in the Arc submenu of the Draw menu.
- Unless otherwise indicated, the phrase "click the mouse" means to press the left mouse button. If another button is to be used, it is specified.
- This Help file is specifically for DesignCAD 97 for Windows 95. For simplicity, however, the program is often referred to as "DesignCAD 97" or simply "DesignCAD."

If you have a question about DesignCAD 97 for Windows 95, before you call please look in the *Reference Manual*, or the on-line Help for the solution. Remember to check the Index and Table of Contents.

If you cannot find the answer to your question in the documentation, contact the DesignCAD Technical Support Department at:

**ViaGrafix Corporation, Software Division**  
**One American Way**  
**Pryor, OK 74361**  
**Telephone: (918) 825-4844**  
**Fax: (918) 825-6359**

When calling, please have the drawing in question open on screen and the *DesignCAD 97 for Windows 95 Reference Manual* at hand.

You can also send questions by electronic mail. Tech Support's e-mail address is: support@viagrafix.com.

Whether you write or call, please provide the following information:

- The serial number and version name of DesignCAD (e.g., DesignCAD 97 for Windows 95).
- The type of hardware you are using.

We also maintain an Electronic Bulletin Board (BBS), a forum on CompuServe and a home page on the Internet's World Wide Web. You can download Windows and DOS device drivers, as well as sample drawings, from the BBS. You can also post messages for the System Operator, as well as review questions and answers posted on technical support issues. The BBS number is 918-825-4847 (14.4 kbps / n,8,1).

You can access our CompuServe forum at **Go DesignCAD**. Our CompuServe e-mail address is 74774,2513.

Look for us on the World Wide Web at: <http://www.viagrafix.com>

### **About DesignCAD 97 for Windows 95**

DesignCAD 97 is a comprehensive computer-aided design package that incorporates a full range of 2-D and 3-D drawing functions. DesignCAD 97 combines the award-winning features of its earlier 2-D and 3-D versions with the 32-bit advantages of Windows 95.

You can use DesignCAD to create drawings for any assignment, from simple to complex, and the finished drawing can be printed using any printer or plotter that Windows 95 supports.

DesignCAD 97 can be customized to fit your particular application. You can create your own Custom Toolbox and even write your own DesignCAD commands using BasicCAD!

With its numerous high-end features, DesignCAD compares favorably with CAD systems costing thousands of dollars. Unlike other high-end systems though, DesignCAD is easy to learn and use. With a little practice, virtually anyone can make detailed drawings of professional quality using DesignCAD.

In addition to its 2-D Mode, DesignCAD 97 is a true three-dimensional CAD system. You can use it to construct realistic 3-D models of your projects. You can show them in wireframe view, with hidden lines removed, or with full-color shading--from any viewing angle. You can also create animation files which step the viewer around your drawing in smooth increments. For example, you could start with an aerial view of a house, descend to ground level, and then walk all around it. You can even assign material properties to your creations, placing a brass doorknob on an oak door, or creating a lavatory of rose marble with chrome fittings.

If you have any DesignCAD 2D or DesignCAD 3D program and DesignCAD 97 for Windows 95, you can interchange drawings between the two applications. You can take a cross-section of a complex beam which you may have created in DesignCAD 2D, load the cross-section into DesignCAD 97 and extrude it into a beam. Then you can save the extruded beam as a DesignCAD 2D drawing, even with hidden lines removed! If you want to go a step further, you can extrude your floor plan into an elevation, add a roof, and save a perspective view back into DesignCAD 2D format.

DesignCAD 97 for Windows 95 imports and exports drawings in DWG, DXF and IGES formats, and also reads and writes Windows Metafiles. DesignCAD can also export WPG, RIB and WRL formats. Other imported formats include HPGL and XYZ. DesignCAD can pass drawing information to and from the clipboard and export OLE 2.0 objects to applications that support them.

# The DesignCAD 97 Drawing Screen

The DesignCAD 97 for Windows 95 drawing screen is shown below. Descriptions of the components follow. For details on how to maximize, minimize, open, and close windows, refer to your Windows 95 documentation.

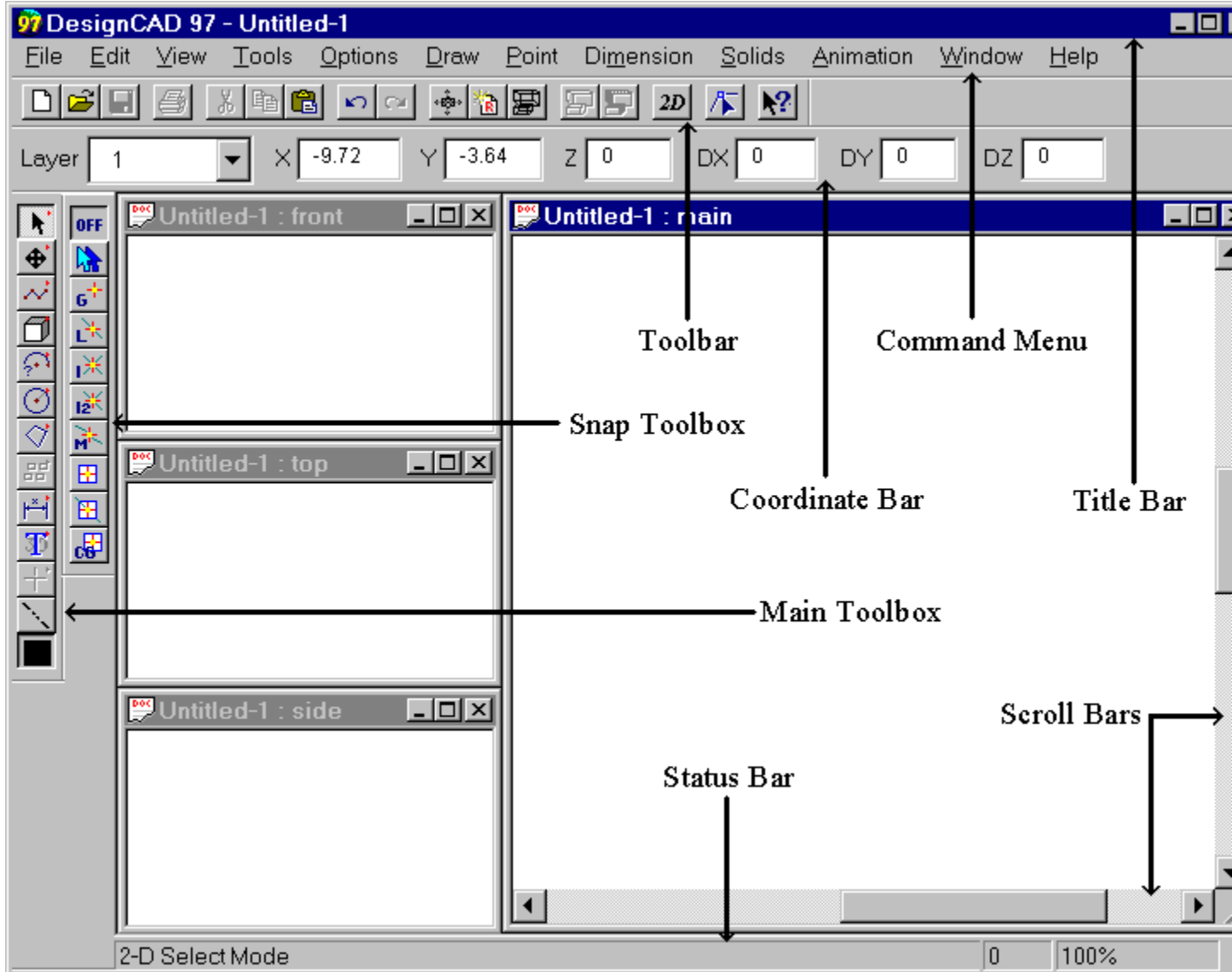

**Color Toolbox:** Changes the current drawing color or applies a specific color to selected items.

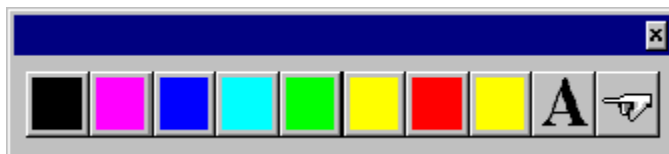

**Command Menu:** Contains the drop-down menu selections. From the command menu you can pick every available DesignCAD 97 command.

**Coordinate Bar:** Displays the cursor's location in 3-D space. If you are executing a drawing command, it displays the distance moved from the last point set as DX, DY, and DZ. The Coordinate Bar also displays the Layer window, which shows the current layer status.

**Custom Toolbox:** Provides quick access to frequently used commands, macros, and BasicCAD programs. You can easily customize the contents of the Custom Toolbox.



**Main Toolbox:** Contains graphic icons for the most frequently used drawing commands.

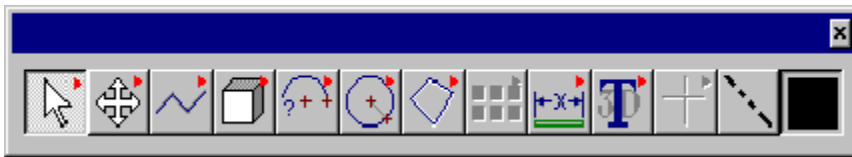

**Material Toolbox:** Gives you control over the color and surface texture of the items you are drawing.



**Scroll Bars:** Let you pan across a drawing that is larger than the screen size.

**Snap Toolbox:** Contains commands to set points at specific locations in the drawing, such as midpoints and intersections. This toolbox can also be moved about on the screen.



**Status Bar:** Displays quick help on using the current command. The status bar may be replaced with a progress bar for certain commands, such as the Shading command.

**Title Bar:** Displays the program name and the name of the currently active drawing (also displays which view is active if more than one view of a drawing is open).

**Toolbar:** Contains a number of icons to speed the selection of frequently used commands and functions. When you start most drawing commands, the **Toolbar** is replaced with the **Command Bar**, which provides options for that command.





**Viewing Toolbox:** Controls the view settings for the currently active view window.



DesignCAD 97 provides multiple ways to access commands.

### Accessing Commands from the Command Menu

To access menu commands using the mouse, click on the menu title of interest. This action pulls down the list of commands available on that menu. You can now pick the command you want by clicking on it.

For the keyboard-conscious, menu commands are also available from the keyboard. You access a menu by pressing **Alt+letter**, where **letter** is the underlined letter in the menu title. To access the EILE menu, for example, press **Alt+F**. You then see a list of available commands, each of which also has an underlined letter. To choose a specific command when the menu is open, press the underlined letter in the command name. To use the LOAD IMAGE FILE command in the EILE menu, for example, press **Alt+F**, then **I**.

For those who like to take shortcuts, many of the commands in DesignCAD have a shortcut key. It's often much faster to go directly to a command using a shortcut rather than using the Command Menu. For example, by pressing **Ctrl+O** you can bypass the menu and immediately use the OPEN command.

Keyboard shortcuts are listed beside the menu commands. For example, EIT TO WINDOW, another command that is used frequently, has **CTRL+W** beside it on the VIEW menu.

### Accessing Commands with the Toolbar

DesignCAD 97 has a convenient Toolbar that provides push-button access to many frequently needed tasks. The available tools are shown below. To use one of these tools, click on it with the mouse.



Creates a new, blank drawing (New command).



Opens an existing user-selected drawing (Open command).



Saves the current drawing (Save command).



Reverses an action performed by a command or by the user (Undo Command).



Reverses an action performed by the Undo command (Redo Command).



Cuts selected entities from a drawing to the Windows clipboard (Cut command).



Copies selected entities to the Windows clipboard, leaving the

original entities intact (Copy command).



Pastes the contents of the Windows clipboard into the current drawing (Paste command).



Prints the current drawing (Print command).



Sets the viewer position (Set View command).



Refreshes the screen image (Refresh command).



Redraws all objects on the active drawing screen (Regenerate command).



Provides a hidden-line view of the current view window (Hidden Line Removal command).



Provides a rendered (shaded) view of the current view window (Shading command).



Activates 2-D Mode.



Activates Point Select Mode.



To get help on something, click on this button, then click on the object in question.

## The Main Toolbox

The Main Toolbox contains tool drawers, which have push buttons for various DesignCAD drawing commands. This arrangement saves space on the drawing screen.



To see the commands stored in a drawer, click on the visible tool and continue to depress the mouse button. After a moment, the drawer slides open, revealing the tools it contains. Keeping the mouse button down, move the cursor onto the tool you want to use, and then release the mouse button. As you move the cursor over a new tool, the status bar at the bottom of the screen gives a brief description of that tool.

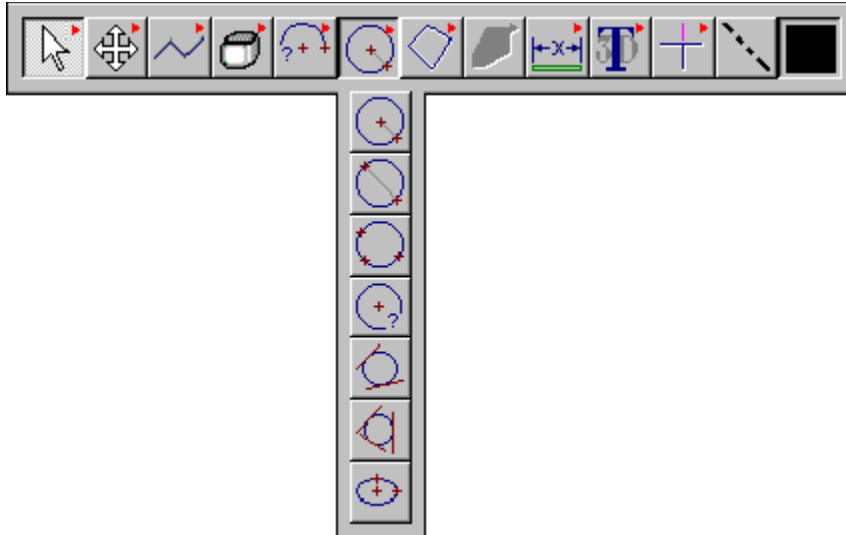

The most recently used command in a drawer is the one that shows in the toolbox. Like most of the toolboxes in DesignCAD 97, the Main Toolbox can be docked to an edge of the drawing screen or, if already docked, pulled loose to float anywhere on screen.

Clicking the Color Tool turns the Color Toolbox on or off, and shows the current drawing color. Clicking on the Line Style Tool (the button with a dashed line) opens the Line Style dialog box.

### The Snap Toolbox

The Snap Toolbox (which is also dockable) contains a convenient set of tools for snapping to precise locations in your drawing. You can click on these tools even if you are in the middle of a drawing command.

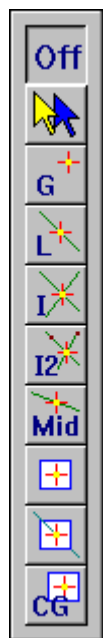

OFF: Turns off any active snap mode.

MOVE/SNAP: Determines whether or not the snap will set a point.

GRAVITY POINT: Snaps to the nearest point in drawing.

LINE SNAP: Snaps to the nearest line/curve/arc in drawing.

INTERSECT-1: Snaps to the nearest intersection of two lines/arcs.

INTERSECT-2: Snaps to the intersection of two chosen lines/arcs.

MIDPOINT: Snaps to the midpoint of the selected line.

PLANE SNAP: Snaps to the nearest point on the closest plane.

LINE PLANE: Snaps to the intersection of a line and a plane.

CENTER OF GRAVITY: Snaps to the center of gravity of an object.

### The Viewing Toolbox

The Viewing Toolbox contains useful tools for modifying the way you look at your drawing in

3-D space. You can change the horizontal viewing angle (the viewer's rotation about the Y axis), the vertical viewing angle ( the viewer's rotation about the X axis), and the tilt (the viewer's rotation about the Z axis).

You can change the orientation of the drawing visually by dragging the mouse. You can choose from a set of pre-defined viewing angles, or you can define your own view. No matter what direction you want to approach your drawing from, DesignCAD's viewing toolbox lets you get there. Like the snap tools, these tools can be used inside another command.



PROJECTION LIST: Select from pre-defined settings.

VIEWER LEFT/RIGHT: Rotates view about the Y axis.

VIEWER UP/DOWN: Rotates view about the X axis.

VIEWER TILT: Rotates the view about the Z axis.

INCREASE/DECREASE DISTANCE: Controls perspective.

SET VIEWER and TARGET LOCATIONS/ROTATE VIEW: These let you set specific locations for the viewer and target, or drag the view rotation manually using the mouse.

You can manually set the viewer rotation angles and view distance settings. To do that, click in the numeric fields beside the buttons and type in the desired numbers. Also, the Viewing Toolbox can be docked to the edge of the DesignCAD window.

## Moving Around in a Drawing

You can move the cursor in the drawing screen using either the mouse or the keyboard.

### Mouse

When you use the mouse, the cursor normally moves along two of the three axes (which two depends on your viewing angles).

In Front View or Perspective View, the mouse moves in the XY plane. To move the mouse along the third axis, first choose a drawing or point command. Then simultaneously press the **Ctrl** and **Shift** keys and continue holding down the keys as you move the mouse. Forward mouse motion goes in a positive direction along the axis, and reverse motion goes in a negative direction.

Holding down the **Shift** key alone forces the mouse to move along one axis in the current viewing plane (X in the Front View). Pressing only **Ctrl** forces the mouse to go along the other axis in the plane (Y in the Front View).

**Note:** In 2-D Selection Mode (the fat arrow cursor), the Ctrl and Shift keys affect the cursor while you are in a drawing or point command.

---

The mouse normally moves in increments of one screen pixel. This distance varies depending on your zoom factor and the original size of the drawing. To constrain the mouse to move in increments of a particular size (1.0, 0.25, etc.), turn on the SNAP GRID and set the SNAP GRID SIZE in the OPTIONS menu. If the change causes your mouse to move in a jerky manner, reduce the value in the SNAP GRID SIZE box. You may have zoomed in on a region only slightly larger than the snap increments.

### Keyboard

When using the keyboard, you move about the screen using the arrow keys. The left and right arrows move you along the horizontal axis (which of the axes is “horizontal” depends on your view angles). The up and down arrows move you along the vertical axis. To move in the third direction, press the **Ctrl** key in combination with **Home** or **End**. To move the cursor in smaller increments in the third direction, press **Shift** in combination with the arrow keys or **Home** or **End**.

You can also specify the size of the cursor movement when using the arrow keys. Use CURSOR STEP in the OPTIONS menu to set the LARGE STEP SIZE (regular arrow keys) and SMALL STEP SIZE (Shift-arrow keys) to convenient values.

## Setting Points

Points form the basis of all drawing commands, determining the location of a line or curve, the diameter of a circle, or the radius of an arc.

You can select point commands from the Command Menu or the Snap Toolbox, or you can use shortcut keys. The Snap Toolbox works the same way as the Main Toolbox does. To choose a point command, click on the icon for the command.

Setting a point is easy. Press **Ins** or click the left mouse button. That's all there is to it. The right mouse button activates the Gravity command. Below is a table listing the point commands and their functions.

**Note:** When Snap commands are selected from the Snap Toolbox, you have the option of making them set a point or just move to the position; however, if you select a Snap command from the Point menu, a point will always be set.

---

<b>Command</b>	<b>Function</b>
GRAVITY:	Snaps to the nearest point in the drawing.
LINE SNAP:	Snaps to the nearest line.
PLANE SNAP:	Snaps to the nearest plane.
INTERSECT-1:	Snaps to the nearest intersection of two lines.
INTERSECT-2:	Snaps to the intersection of two chosen lines.
LINE PLANE:	Snaps to the intersection of a line and a plane.
MIDPOINT:	Snaps to the midpoint of a line.
CENTER OF GRAVITY:	Finds the center of gravity of a solid.
ORIGIN:	Moves the origin of a drawing to a chosen point.
POINT XYZ:	Sets a point using X, Y, Z coordinates.
POINT RELATIVE:	Sets a point using relative X, Y, Z coordinates.
POINT POLAR:	Sets a point using polar coordinates.
GRAVITY MOVE:	Moves to the nearest point without setting a point.

## Drawing to Scale

When you draw to scale in DesignCAD, you are usually measuring the objects in a given base unit of measure. DesignCAD doesn't care whether your base unit is meters or miles or even leagues. What's important is that you use the same base unit throughout the drawing.

Let's say that you're drawing a house and the front wall is 32 feet long. To DesignCAD, it is 32 Drawing Units. You can draw a line by choosing the Line command, setting the first point (click the mouse or press **Ins**), then specifying that the next point is 32 Units away.

But what if the next item you measure in the same drawing is 10 centimeters tall? If you draw it at a height of 10 units, it will be much too large. Why? Because centimeters and feet are different units. In this example, you would need to convert the centimeters to feet, and then tell DesignCAD the size of the item in feet.

The key point is not to mix units. If feet are convenient, call out all distances in the drawing in feet. If centimeters are convenient, measure everything in centimeters. As long as you're consistent, all is well. If you use feet, many of the commands allow you to enter distances in feet and inches: for example, to specify a line 9 feet 5 inches long, set the first point, then enter **9'5"** in the DX field of the Point Relative command.

## Printing to Scale

What about printing to scale? The Print screen shows the paper units selected and the scale of the printout. Scale here represents the number of paper units it takes to print one drawing unit.

Suppose we have drawn a 10-inch box, which we specified as 10 units when we drew it. Now we want to print it at 0.25 scale. The paper units default to inches, and our drawing is also in inches. Therefore it takes 0.25 inches on paper to represent one inch in the drawing. Our 10-inch box comes out 2.5 inches long on paper.

If our box had been specified at 10 feet instead of 10 inches, then it would take  $1/4$  inch of paper to represent 1 foot in the drawing. This is a real-world scale of  $1/48$ , or 0.0208333. But to DesignCAD units are just units, so the scale is still shown as 0.25. It took 0.25 *paper units* (inches) to represent one *drawing unit* (feet). Printing scale is the length on paper that will represent one drawing unit.

We can show it as an equation:

**True Scale = Scale/Ratio** (where *Ratio* is the number of paper units in one drawing unit)

In the example above, our scale is .25. The paper unit is in inches, the drawing unit in feet. Since there are twelve inches in one foot, the Ratio equals twelve.

**True Scale = Scale/Ratio = .25/12 = 1/48**

What if your paper is too small to print at the scale you need? No problem. DesignCAD can print out your drawing in panels, all to scale, which you can then assemble into a composite drawing.

## Selecting Objects

Many of DesignCAD's commands work only on selected objects. Other commands work on the entire drawing or selected items only, depending on the options you choose. Below are instructions for selection tasks you'll often use in your drawings.

### Selecting a single object

Move the arrow-shaped cursor near the object and click. If you are close enough, the object is selected, turning magenta and showing a blue bull's-eye where you clicked. The bull's-eye is the selection handle. If you click too far away, either nothing gets selected or something closer to the cursor than the object you want gets selected. Pressing **Esc** will clear the current selection, as will clicking in a blank region of the screen.

**Note:** Pressing **Del** erases the current selection.

---

With the Gravity command, it's easy to select an object and simultaneously set the handle at an exact location in the object. To set a GRAVITY point, right-click the mouse or press the . (period) key with the cursor near the desired point. The cursor snaps to the point and sets a point there.



### **Selecting a group of objects in a region**

Move the mouse to one corner of the region. Hold down the left button and drag a selection rectangle around the region. Release the mouse button at the opposite corner. Every item that was completely enclosed in the region is now selected. The handle is placed at the center of the rectangle.

### **Selecting objects enclosed in or touching a selection rectangle**

Click and drag the selection rectangle, but press **Ctrl** before releasing the mouse button. (Remember not to hold down **Ctrl** as you drag; if you do, you'll restrict the mouse's movement to only one direction.)

### **Adding or deselecting a single item**

To add a single item to the selection set, or to de-select a single item in a selection set, move the mouse near the item, press **Shift**, and click.

### **Adding a group of objects to the selection set**

Drag a selection rectangle as in normal selection, but press **Shift** before releasing the mouse button. The items must be completely enclosed by the rectangle to be affected. Any items in the region which were already selected will be de-selected. (Remember not to hold the **Shift** key down as you drag, or you force the mouse to move along a single axis.)

### **Selecting specific items**

Sometimes you need to be even more specific about which items you want to select. In DesignCAD you can select objects by dragging a 3-D rectangle around them. If you press **Ctrl+3** while your arrow cursor is showing, it turns into a 3-D cursor like the one you see when you draw a line. This signifies that you are now in 3-D Selection Mode. You select items as before, but for regional selections, you must enclose the items in a 3-D selection box rather than a simple 2-D rectangle. To return to the 2-D Selection Mode, press **Ctrl+2**.

### **Selecting all objects**

Finally, let's not overlook the convenience of SELECT ALL. This command, located in the EDIT menu, selects every object in the drawing.

## **Using Selection Handles**

When you work with selected objects, you often need some way to specify how DesignCAD will manipulate the items. This is the purpose of selection handles. The handles are the specific points in the object that DesignCAD moves, copies, extrudes, or rotates. The rest of the object is built around the handles, using the same relative relationships as the original object. The way you place the handles determines the location, size, and orientation of your object.

In many cases, you just want to move your object, or a copy of it, somewhere else in the drawing. For these tasks, one handle is enough.

At other times, however, you might need to control the size and orientation of the moved or copied object. Now you need two, or possibly even three handles by which to locate the object. Handle 1 establishes the starting location for the object. Handle 2 provides a reference point for both the direction and scale of the object's primary axis. Handle 3 provides

a second directional reference for orientation.

### Placing specific handles

You can set specific selection handles on a selected object or group by pressing **Ctrl+H** or using **EDIT | SELECTION | SET HANDLES**. The status bar prompts you to set one, two, or three points for the handles. If you set less than three, press **Enter** to end the command.

You can use any of the point commands to set these handles, including Point XYZ, Point Relative, and Gravity Point. You can set or change your handles even if you are already in another drawing command.

### More Information—The Info Box.

Suppose you have selected an item, but you don't know what its properties are. The Info Box provides you with the answers. It tells you what kind of drawing object the item is, what layer the object is in, the object's color, and its material.

The Info Box also gives you the ability to change those object properties directly.



### Using the Info Box

Let's say we have selected a 3-D box, which is a solid. Suppose we want to double its size, expanding it from the top downward. To do this, first select the box and place a handle anywhere along its top edge. Next, press **Ctrl+I**, or pick **VIEW | INFO BOX**, to show the Info Box and click the Expand button (the one with two arrowheads pointing to the right). A Solid dialog box appears. Change the Y-SCALE to **2.0** and click or **Tab** into a different field. The box grows downward to twice its original size.

If we want it to grow upward from the bottom, we would place the handle on the bottom edge. Similarly, we could transform this box into a slab of marble by using the **MATERIAL** button in the Info Box to select a marble texture.

### All This and Color, Too...

DesignCAD 97 gives you 64 basic drawing colors. By default there are seven base colors in eight deepening shades each, and eight other lively colors. However, if the supplied colors don't meet your needs or fit your tastes, you can create your own.

The Color Toolbox has eight color buttons, an "A" button, and a "pointing finger" button. The A (for "Apply") button applies the current drawing color to the items you have selected. The pointing finger is used to grab the color of the pointed-to object and make that the current drawing color. The other eight buttons are available drawing colors.

How do you get to all 64 colors? Click on one of the color buttons and hold down the button. This opens the color drawer, which shows eight different colors hidden under one tool. These

work like the tools in the Main Toolbox: click, hold down, slide the pointer over to the color you want, and release. The color you picked shows up at the bottom of the Main Toolbox, indicating that it is now the active drawing color. It also becomes the top color in its drawer.

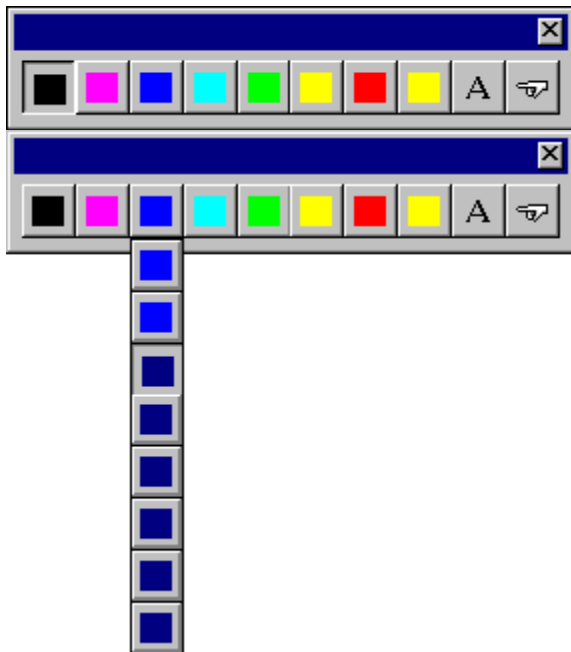

If you want to edit a color, make that color the top one in its drawer. Then double click on it to activate the EDIT COLOR command.

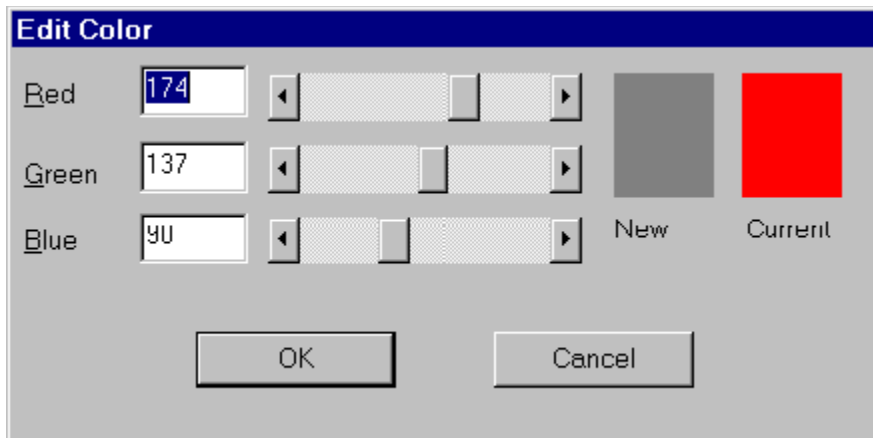

You can click on the left and right arrows, drag the sliders, or directly enter the desired Red, Green, and Blue values. The proposed new color is displayed beside the current one. It is updated as you change the settings. Choose OK to keep the new color, or press CANCEL to leave the current color intact.

### **The Material Toolbox**

DesignCAD 97 comes with more than 20 pre-defined material types for you to draw with. Using the Material Toolbox you can create your own materials from a set of customizable textures and properties. Any material can be applied to any object in a drawing.

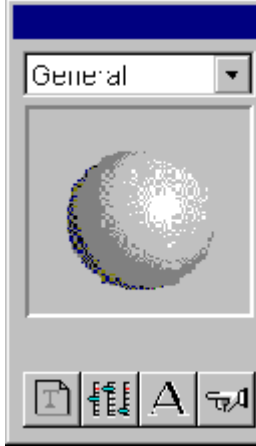

The Material Toolbox has seven areas of interest:

1. 1. The control button at the upper-right corner
1. 2. The Material List box
1. 3. The Material Preview box
1. 4. The New Material tool
1. 5. The Edit Material tool
1. 6. The Apply Material tool
1. 7. The Pick Material tool

You can dock the Material Toolbox to the side of the screen, let it float, or turn it off. The control button (the "x" sign in the upper-right corner) is used to turn the toolbox off. Use the blue bar beside it to drag the tool around the screen.

If you click on the down arrow, the Material box shows a list of material types available for use. The list includes any materials you have created and added to the list.

**Note:** Don't confuse this list with the Material List command in the File menu. The Material List command provides a net listing of all the attributes you placed in your drawing. Material, as it is referred to in the Material Toolbox, affects the appearance of shaded drawings. Attributes are generally used to denote physical materials—lumber, bolts, screws, and other parts—used to build the object depicted in your drawing.

---

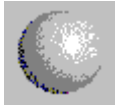

The Material Preview box shows how a sphere of that material looks when shaded.



The New Material tool opens up a miniature workshop where you design your own new substances for DesignCAD to render:

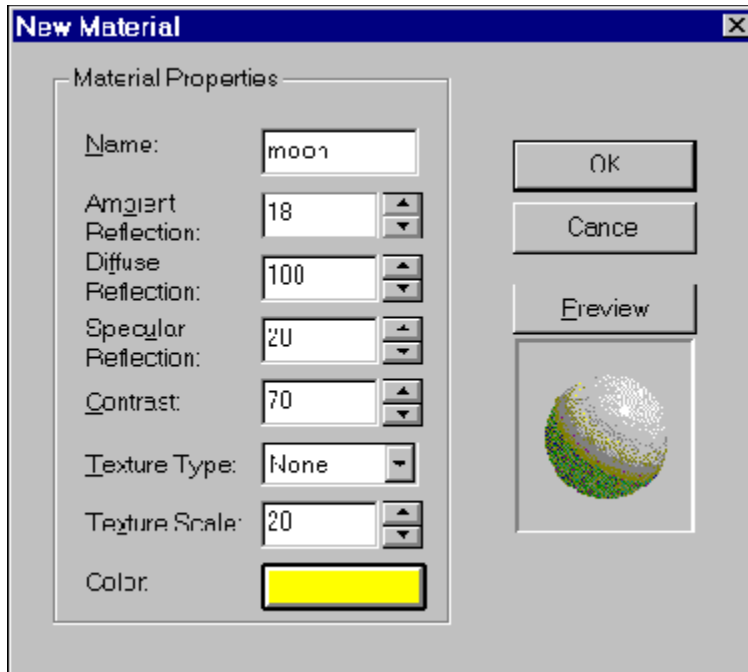

The example above shows the new (created) material MOON, a pale, rough substance.

Choose the OK button to accept the current settings, or CANCEL to discard your changes and return to the drawing.



The Edit Material button brings up almost the same screen, with additional buttons for Add, Delete, Save, and Retrieve.

From this screen you can edit the current material (standard library materials cannot be edited). You can also save your new material to disk, retrieve a material from disk for further editing, delete a material from the list, or add another new material. If you choose Add, the current material properties become the default settings in the New Material screen. You can edit them there.

Choose OK to keep your new material. Choose CANCEL to return to the current material properties. Either choice drops you into the Edit Material screen. In editing properties, the higher the number, the more noticeable that property is in your drawing.

### Material Properties:

**Name:** the name of the new substance (limited to 16 characters or less).

**Ambient:** the amount of random background light reflected on the object.

**Diffuse:** controls the percentage of light the object reflects.

**Specular:** controls how shiny the object is.

**Contrast:** controls the degree of difference between light and dark areas.

<b>Texture Type:</b>	the kind of surface the object has: none, sandy, marbled, etc.
<b>Texture Scale:</b>	controls the coarseness of the texture.
<b>Color:</b>	sets the default color of the material.

DesignCAD 97 is a Microsoft Office 97 Compatible product, which means that many of its basic features (including toolbars, menus, & accelerator keys) are similar to those used by Microsoft Office. If you are already using Office or an Office 97 Compatible product, then you will see that many tasks can be completed in a similar manner in DesignCAD 97. These similarities will make it easier for you to use Office 97 Compatible products together.

Look for the Microsoft Office 97 Compatible logo when purchasing software. For more information about the Microsoft Office 97 Compatible program, and for a complete listing of Microsoft Office 97 Compatible products, please see our web site at <http://www.microsoft.com/office/compatible> or call Microsoft Customer Service at 1-800-426-9400. Customers outside the United States should contact their local Microsoft office.

### **Office 97 Compatible Features Supported by DesignCAD 97**

- § § DesignCAD 97 contains a toolbar which is similar to the one found in Microsoft Office. You can print a document just by clicking the “Print” button on the standard toolbar.
- § § DesignCAD 97 also has ToolTips for not only the toolbar but also the various DesignCAD toolboxes. ToolTips allow you to discover each button’s function just by pointing to it with the mouse.
- § § DesignCAD 97 supports Microsoft’s Intellimouse. The roller ball between the two mouse buttons can be used to scroll up or down in the currently active view window. This roller ball may also be used while pressing the **Ctrl** key on the keyboard to zoom the drawing using the cursor position as the zoom origin.
- § § The DesignCAD 97 menus have been rearranged slightly to more closely match the menus found in Office 97 products. For Office 97 users who are just getting started with DesignCAD products, these changes make DesignCAD 97 easier to learn than any previous DesignCAD product.
- § § DesignCAD users that have upgraded to DesignCAD 97 in the hopes that it will more closely resemble and integrate with other Office 97 compatible products, will find that rearranging the menus has not affected the simplicity and functionality of the DesignCAD user-interface. These users will also be surprised at how quickly they will learn the new locations of commands on the menus.

### **Differences Between DesignCAD 97 and Some Office 97 Compatible Products**

- § § Some of the tool icons and commands in the menus may be enabled or disabled at different times than those of equivalent commands in some Office 97 compatible products. One of these differences is the DesignCAD 97 Save tool in the Toolbar. This tool is not enabled until the user draws something.

- § § The Print Preview command commonly found under the File menu in Office 97 compatible products, has been changed to a button in the Print dialog box. Because of the large number of options that determine how a drawing will be printed, the Print Preview function has been integrated with the Print command in an effort to make the task of previewing a drawing easier and less time consuming. To preview your drawing select the PRINT command. The DesignCAD Print Command dialog box appears. Now click on the PREVIEW button. The DesignCAD Print Preview dialog box appears. After viewing the preview of how the drawing will be printed using the currently selected options, click the CLOSE button to return to the DesignCAD Print Command dialog where you can print the drawing or change the print options and preview the drawing again.
- § § The Page Setup command commonly found under the File menu in Office 97 compatible products, has also been changed to a Setup button in the Print dialog box. This change allows the orientation of the drawing for printing to be changed quickly and easily after a print preview. One benefit of this simplification is the ease with which a paneled drawing that has just been previewed can be changed from landscape to portrait orientation. This can not only make a printed drawing appear more proportional to the paper on which it is printed, but also save paper.
- § § In the Edit menu two commands have been placed between the Cut and Copy commands. The two added commands are Erase and Erase Last. The reason for these additions at the chosen location is because of the similarities between Cut, Erase, and Erase Last. As with the Cut command, the Erase command removes selected objects from a drawing; the difference is that the Erase command does not place the removed objects on the Windows Clipboard. Similarly the Erase Last command removes an object from a drawing (without placing it on the Clipboard), the difference between Erase Last and Erase is that the object that is removed is not the selected object(s) but the last object drawn.
- § § Also In the Edit menu one command has been placed between the Copy and Paste commands. The added command is Copy Image. The reason for this addition at the chosen location is because of the similarities between Copy and Copy Image. As with the Copy command, the Copy Image command copies part of a drawing. The difference is that the Copy Image command does not copy the drawing objects used to produce an image like the Copy command. The Copy Image command merely copies the image produced by the drawing objects.
- § § The option to save as a JPEG image file is located in the Save Image dialog box, not in the Save As dialog box like the option to save as HTML in Office 97.
- § § The file dialog boxes are also a little different in DesignCAD than in some Office 97 compatible products. For example, dialog boxes in commands such as Open, Load Symbol, and Load Image contain a preview area. Because DesignCAD is a drafting/graphic-producing application, the ability to preview a file is extremely helpful. With the addition of a preview area, the user is not forced to open several drawings in order to find the correct file.
- § § The file dialog boxes do not include file extensions in the Files of Type list box. Previous versions of DesignCAD were 2D or 3D versions available for DOS, Windows 3.1, and Windows 95. The 2D versions needed different extensions than the 3D versions so that they would not be confused, and the DOS and Windows versions needed different extensions because of the difference in file type. Because DesignCAD 97 is a combined 2D and 3D CAD package and backward compatible, it is less confusing to new users if these extensions are removed from the Files of Type list boxes and only the descriptions are used.

- § § Unlike some Office 97 compatible products, DesignCAD does not have a Zoom list box in the Main Toolbar. DesignCAD zooms a drawing using a zoom origin, which allows the user to zoom in or out many times on a specific area. In DesignCAD's zoom commands, the user can position the cursor in the drawing and click the left mouse button. The cursor position is used as the zoom origin or (center of the zoom). Similarly, zooms executed with the Microsoft Intellimouse while pressing the **Ctrl** key on the keyboard to zoom the drawing use the cursor position as the zoom origin, even though it is not necessary to click the mouse button.
- § § DesignCAD's equivalent of the Toolbar Configuration Dialog Box is located in the View folder of the Options file box. Just like the Toolbar Configuration Dialog Box in some programs, the View folder allows users to show or hide the various toolbars that are available in DesignCAD. The View folder is accessed by selecting the OPTIONS command from the TOOL menu and then clicking on the VIEW tab or by selecting the SHOW/HIDE command from the VIEW menu. This is consistent with the intent of making as many of DesignCAD 97's options available from a single location as is reasonably possible.

## Using DesignCAD 97 with Microsoft Office

A DesignCAD 97 drawing can be transferred into Microsoft Office using 2 major methods. The first of these methods just displays the drawing in an Office compatible product. The second major method of transferring a DesignCAD 97 drawing into an Office compatible product embeds the drawing objects into a Microsoft Office application so that the drawing can be edited later using DesignCAD 97. A variation of the second method involves inserting a DesignCAD 97 drawing as an object into a Microsoft Office document so that the DesignCAD 97 tools will be used to edit the drawing inside the Office 97 application.

### 1. Displaying a DesignCAD 97 Drawing in a Microsoft Office Application

Draw or open a saved drawing in DesignCAD. Press **Ctrl+A** for the Select All command, or select the objects to be copied into the Microsoft Office document by selecting individual objects with the mouse (remember: to select multiple objects, move the mouse to the object to be added to the selection, press the **Ctrl** key on the keyboard and click the left mouse button on the object). Once the portion of the drawing that you want to copy is selected press **Ctrl+C**. Now open the Microsoft Office application and document in which the drawing is to be displayed. Select PASTE SPECIAL from the EDIT menu and click the PICTURE option in the resulting dialog box.

There is also another way to display the entire drawing in an Office compatible product, but it can also display only a section of the drawing that contains portions of several drawing objects. Draw or open a saved drawing in DesignCAD. Select the COPY IMAGE command from the EDIT menu. Set two points in the drawing area that define opposite corners of the section to be copied to the Clipboard. The section is automatically copied to the Clipboard after the second point is set. Now open the Microsoft Office application and document in which the drawing is to be displayed. Press **Ctrl+V** for the Paste command or select it from the Edit menu. This copies only the drawing information from the section of the drawing specified with the Copy Image command into the Office document.

### 2. In-Place Editing

In-Place Editing allows you to edit an embedded or inserted DesignCAD drawing in a Microsoft Office application.



A. Draw or open a saved drawing in DesignCAD. Press **Ctrl+A** for the Select All command. Press **Ctrl+C** to copy the selection to the Windows Clipboard. Now open the Microsoft Office application and document in which the drawing is to be displayed. Press **Ctrl+V** for the Paste command or select it from the Edit menu.

-or-

B. Open the Microsoft Office application and document in which the drawing is to be displayed. Select OBJECT from the INSERT menu. Select DesignCAD drawing from the list of options in the resulting dialog box.

---

**Note:** The only two methods by which the embedded drawing can be edited depends on whether DesignCAD is running in the background or not.

1. When you double-click on the drawing in the Microsoft Office document and DesignCAD is running in the background, DesignCAD will move in front of the Microsoft Office application and take the focus to allow you to edit the embedded drawing.

2. When you double-click on the drawing in the Microsoft Office document and DesignCAD is *not* running in the background, DesignCAD's menus will replace those of the Microsoft Office application so that the DesignCAD 97 commands may be used to edit the embedded drawing in the Microsoft Office application.

---

A  
B  
C  
D  
E  
F  
G  
H  
I  
J  
K  
L  
M  
N  
O  
P  
Q  
R  
S  
T  
U  
V  
W  
Z

[2-D Mode Command](#)

[2-D Selection Mode](#)

[3-D Selection Mode](#)

**A**

[About DesignCAD Command](#)

[Add Menu Item Command](#)

[Align Drawing Command](#)

[Angle & Distance Between Points Command](#)

[Angle Between Two Lines Command](#)

[Animation Mode Command](#)  
[Arc Command](#)  
[Arc \(3-Point\) Command](#)  
[Arc \(Center, Begin, End\) Command](#)  
[Arc \(Endpoints, Center\) Command](#)  
[Arc \(Radius, Begin-End\) Command](#)  
[Area Command](#)  
[Arrange Icons Command](#)  
[Array Command](#)  
[Arrow Command](#)  
[Attribute Command](#)  
[Auto Trace Bitmap Command](#)  
[AVI Command](#)

## **B**

[Balloon Command](#)  
[Bearing Command](#)  
[Bezier Curve Command](#)  
[Box Command](#)  
[Break Line Command](#)

## **C**

[Calculator Command](#)  
[Cascade Command](#)  
[Center of Gravity Command](#)  
[Chamfer Command](#)  
[Circle \(3-Point\) Command](#)  
[Circle \(Center, Outside\) Command](#)  
[Circle \(Center-Radius\) Command](#)  
[Circle \(Diameter\) Command](#)  
[Circle Tangent to Two Lines Command](#)  
[Circle Tangent to Three Lines Command](#)  
[Circular Array Command](#)  
[Close Command](#)  
[Close Digitizer Menu Command](#)  
[Color Options](#)  
[Combine Lines Command](#)  
[Command Dialog Command](#)  
[Command Line Entry Command](#)  
[Cone Command](#)  
[Continue Recording Command](#)  
[Control Panel Command](#)  
[Copy Command](#)  
[Copy Image Command](#)  
[Create Digitizer Menu Command](#)

[Create Walk Through Command](#)

[Crosshair Command](#)

[Cursor Command](#)

[Cursor Options](#)

[Curve Command](#)

[Curve to Line Command](#)

[Custom Color Command](#)

[Cut Command](#)

[Cut Plane Command](#)

[Cylinder Command](#)

## **D**

[DesignCAD Tile Command](#)

[Digitizer Tracing Mode](#)

[Dimension Command](#)

[Dimension Angle Command](#)

[Dimension Arc Command](#)

[Dimension Baseline Command](#)

[Dimension Chamfer Command](#)

[Dimension Coordinate Command](#)

[Dimension Diameter Command](#)

[Dimension Distance Only Command](#)

[Dimension Extended Command](#)

[Dimension Options](#)

[Dimension Progressive Command](#)

[Dimension Radius Command](#)

[Dimension Radius Progressive Command](#)

[Display Grid Command](#)

[Drawing Info Command](#)

[Duplicate Command](#)

## **E**

[Ellipse Command](#)

[Elliptical Arc Command](#)

[Entity Select Command](#)

[Erase Command](#)

[Erase Last Command](#)

[Exit Command](#)

[Explode Command](#)

[Export Command](#)

[Extrude Command](#)

## **F**

[File Location Options](#)

[Fillet Command](#)

[Fillet Corner Command](#)  
[Fillet Edge Command](#)  
[Fit to Window Command](#)  
[Fit to All Windows Command](#)

## **G**

[General Options](#)  
[Gravity Command](#)  
[Gravity Move Command](#)  
[Grid Options](#)  
[Group Define Command](#)  
[Group Explode Command](#)

## **H**

[Hammer Command](#)  
[Hatch Command](#)  
[Hatch Fill Command](#)  
[Hatch Line Command](#)  
[Hemisphere Command](#)  
[Hidden Edge Command](#)  
[Hidden Line Removal Command](#)

## **I**

[Import Command](#)  
[Info Box Command](#)  
[Interference Check Command](#)  
[Intersect-1 Command](#)  
[Intersect-2 Command](#)

## **J**

[Join Endpoints Command](#)

## **K**

[Keyboard Command](#)  
[Keyboard Options](#)

## **L**

[Layer Command](#)  
[Layer Options](#)  
[Light Source Command](#)  
[Light Source Options](#)  
[Line Command](#)  
[Line Distance Command](#)  
[Line Plane Command](#)  
[Line Snap Command](#)  
[Line Style Box Command](#)  
[Line to Curve Command](#)

[Load Animation Template Command](#)

[Load Digitizer Menu Command](#)

[Load Image File Command](#)

[Load Symbol Command](#)

## ***M***

[Macro Execute Command](#)

[Macro Record Command](#)

[Macro Toolbox Command](#)

[Make Plane Command](#)

[Material Command](#)

[Material Options](#)

[Material List Command](#)

[Menu Command](#)

[Menu Options](#)

[Midpoint Command](#)

[Mirror Command](#)

[Most Recently Used Files Command](#)

[Move Command](#)

## ***N***

[New Command](#)

[New Window Command](#)

## ***O***

[Open Command](#)

[Options Command](#)

[Origin Command](#)

[Original Size Command](#)

[Ortho Command](#)

[Ortho Line Command](#)

## ***P***

[Pan Command](#)

[Parallel Command](#)

[Parallel by Distance Command](#)

[Paste Command](#)

[Pause Recording Command](#)

[Perpendicular Plane Command](#)

[Perpendicular From a Line Command](#)

[Perpendicular to a Line Command](#)

[Plane Command](#)

[Plane Snap Command](#)

[Plane Subtract Command](#)

[Point Control Commands](#)

[Pointmark Command](#)

[Point Move Command](#)  
[Point Polar Command](#)  
[Point Relative Command](#)  
[Point Select Mode](#)  
[Point XYZ Command](#)  
[Polygon \(Center-Vertex\) Command](#)  
[Polygon \(Edge\) Command](#)  
[Print Command](#)  
[Pullout Command](#)  
[Pyramid Command](#)

## **Q**

[Quarter Circle Command](#)

## **R**

[Record Options Command](#)  
[Redo Command](#)  
[Refresh Command](#)  
[Regenerate Command](#)  
[Regenerate All Views Command](#)  
[Remove Menu Item Command](#)  
[Reset Working Plane Command](#)  
[Restore DesignCAD Tile Command](#)  
[Rotate Command](#)  
[Rounded Box Command](#)  
[Ruler Command](#)  
[Run Executable Command](#)  
[Run Walk Through Command](#)

## **S**

[Save Command](#)  
[Save Animation Template Command](#)  
[Save As Command](#)  
[Save Current View Command](#)  
[Save Digitizer Menu Command](#)  
[Save Image File Command](#)  
[Scale Command](#)  
[Scale Ortho Command](#)  
[Scan Image Command](#)  
[Screen Configuration Load Command](#)  
[Screen Configuration Save Command](#)  
[Section Cutoff Command](#)  
[Section Delete Command](#)  
[Segment Command](#)  
[Select All Command](#)  
[Selection Filter Command](#)

[Selection Zoom Command](#)  
[Select Previous Command](#)  
[Select Scanner Command](#)  
[Semi Circle Command](#)  
[Send All Open Documents Command](#)  
[Send Current Document Command](#)  
[Set As DesignCAD Tile Command](#)  
[Set Drawing Handles Command](#)  
[Set Handles Command](#)  
[Set Grid Center Command](#)  
[Set View Command](#)  
[Set Working Plane Command](#)  
[Shading Command](#)  
[Show/Hide Command](#)  
[Sketch Command](#)  
[Slant Command](#)  
[Slice Command](#)  
[Smooth Lines Command](#)  
[Snap Grid Command](#)  
[Snap Grid Size Command](#)  
[Solid Add Command](#)  
[Solid Define Command](#)  
[Solid Explode Command](#)  
[Solid Intersect Command](#)  
[Sphere Command](#)  
[Stop Macro Command](#)  
[Stop Recording Command](#)  
[Stretch Command](#)  
[Subtract Command](#)  
[Surface Area Command](#)  
[Surface Connect Command](#)  
[Surface Intersection Command](#)  
[Surface Patch Command](#)  
[Sweep Command](#)  
[Symbol Library Command](#)

## ***T***

[Tangent Arc Command](#)  
[Tangent Between Circles Command](#)  
[Tangent From Circle Command](#)  
[Tangent to Circle Command](#)  
[Text 2-D Command](#)  
[Text 3-D Command](#)



[Text Arc Command](#)  
[Text Block Command](#)  
[Text Options](#)  
[Texture Mapping Command](#)  
[Tickmark Command](#)  
[Tile Horizontal Command](#)  
[Tile Vertical Command](#)  
[Time Line Command](#)  
[Toolbar Command](#)  
[Toolbox Options](#)  
[Torus Command](#)  
[Trim Between Two Lines Command](#)  
[Trim Double Lines Command](#)  
[Trim One Line Command](#)  
[Trim Two Lines Command](#)  
[Truncated Cone Command](#)  
[Tube Command](#)

## **U**

[Undo Command](#)  
[Units Command](#)

## **V**

[Vector Convert Command](#)  
[View Options](#)  
[Volume Command](#)  
[VRML Command](#)  
[VRML WWW Anchor Command](#)

## **W**

[Wall Command](#)  
[Weld Command](#)

## **Z**

[Zoom Command](#)  
[Zoom In Command](#)  
[Zoom Out Command](#)  
[Zoom Previous Command](#)  
[Zoom Redo Command](#)

## Zoom Window Command

Menu: OPTIONS  
Menu Command: 2-D MODE

Toolbar Icon: 

The 2-D Mode command shifts the viewer perspective to a front view and treats operations as if they were only occurring in 2-D space. This makes it very easy to use DesignCAD 97 to draw just as you would in a regular 2-D drafting package.

If your drawing contains 3-D objects, it will still be a 3-D drawing; however the cursor will only move parallel to the X and Y axes, with the Z-coordinate set to zero. This makes it very easy to add 2-D information to your drawing.

### Using the command

Choose 2-D MODE from the OPTIONS menu. The command acts as a toggle. When you are in 2-D Mode, the menu will have a check beside the command. Choosing the command will toggle the drawing mode into or out of 2-D mode depending on the current mode.

**Note:** In 2-D Mode, the Trim commands ignore the 3-D aspects of any existing lines, and treat them as flat projections onto the XY plane. This means you can trim lines that would never meet in 3-D space against each other's Front-View projections in 2-D space. This is a powerful feature, but you must pay careful attention to what you are doing.

---

Menu: OPTIONS  
Menu Command: 2-D SELECTION MODE  
Shortcut Key: **Ctrl+F9**

Toolbox Icon: 

Point 1: Object to be selected or first corner of selection rectangle  
Point 2: Second corner of selection rectangle (optional)

Most DesignCAD 97 commands require drawing objects to be selected. For example, to erase an object you can select it and then press the **Del** key.

The 2-D Selection Mode causes the selections to take place with respect to the drawing screen. When you click on an object, the object closest to the cursor on the screen will be selected, not the closest object in 3-D space. The two are not always the same.

### Using the Command

There are three ways to select objects in DesignCAD 97:

- Click directly on the object.
- Drag a selection rectangle around a region.
- Choose the SELECT ALL command.

If you drag a selection rectangle around a region, objects inside that rectangle will be included in the selection. To include objects that touch the selection rectangle, hold the **Ctrl** key down during the selection.

The **Shift** key can be used to add items to the current selection set. For example, to select to objects in the drawing, you can select one and then hold the **Shift** key down while you select the other.

When you select something by dragging a selection rectangle in 2-D Selection Mode, the objects inside the rectangle are selected, regardless of their “depth.” With 3-D Selection Mode you drag a three-dimensional box, and objects must lie inside the box on all three dimensions to be selected.

---

**Note:** A DesignCAD drawing is always in either 2-D Selection Mode or 3-D Selection Mode. To change the selection mode, select the 2-D SELECTION MODE command from the OPTIONS menu which toggles DesignCAD into 2-D Selection Mode (and out of 3-D Selection Mode) or out of 2-D Selection Mode (and into 3-D Selection Mode).

You may also select the 2-D Selection Mode tool or the 3-D Selection Mode tool in the Main Toolbox. If 3-D Selection Mode is active, the 3-D Selection Mode tool will be visible in the Main Toolbox. Click and hold on the 3-D SELECTION MODE tool; the tool drawer will slide out. While still holding the mouse button, move the cursor over the 2-D SELECTION MODE tool. Release the mouse button to put the currently active drawing in 2-D Selection Mode.

---

In 2-D Selection Mode, the cursor is the familiar mouse arrow. In 3-D Selection Mode, the cursor is a 3-D cursor made up of three lines parallel to the X, Y, and Z axes.

**Example: Draw any object on the screen and select it.**

Move the cursor to any point on the object and click the left mouse button. The object changes color to signify that it is selected.

***See Also: 3-D Selection Mode***

Shortcut Key: **Ctrl+3**



Toolbox Icon:

Point 1: One corner of the selection box

Point 2: Opposite corner of the selection box

The 3-D Selection Mode changes the selection mode of DesignCAD 97 so that selections are made in 3-D space rather than with respect to the drawing screen.

In 3-D Selection Mode, the selection takes place in three dimensions. When you select an object by clicking on it, the cursor must be on the object on the X, Y, and the Z axis. When you select an object by dragging a box around it, the object must be enclosed along X, Y, and Z axes, not just the left, right, top, and bottom.

### Using the Command

There are three ways to select objects in DesignCAD 97:

- Click directly on the object.
- Drag a selection rectangle around a region.
- Choose the SELECT ALL command.

If you drag a selection rectangle around a region, objects inside that rectangle will be included in the selection. To include objects that touch the selection rectangle, hold the **Ctrl** key down just before you release the mouse button as you complete the selection rectangle. Don't hold it down while dragging the cursor.

The **Shift** key can be used to add items to the current selection set. For example, to select to objects in the drawing, you can select one and then hold the **Shift** key down while you select the other.

When using commands like Gravity in 3-D Selection Mode, the cursor snaps to the point that is closest in 3-D space, not necessarily the one that appears to be nearest the cursor on the screen. It's easy to use 3-D Selection Mode using the DesignCAD Tile views. This allows you to see objects from all sides.

---

**Note:** A DesignCAD drawing is always in either 2-D Selection Mode or 3-D Selection Mode. To change the selection mode, select the 2-D SELECTION MODE command from the OPTIONS menu which toggles DesignCAD into 2-D Selection Mode (and out of 3-D Selection Mode) or out of 2-D Selection Mode (and into 3-D Selection Mode).

You may also select the 2-D Selection Mode tool or the 3-D Selection Mode tool in the Main Toolbox. If 2-D Selection Mode is active, the 2-D Selection Mode tool will be visible in the Main Toolbox. Click and hold on the 2-D SELECTION MODE tool; the tool drawer will slide out. While still holding the mouse button, move the cursor over the 3-D SELECTION MODE tool. Release the mouse button to put the currently active drawing in 3-D Selection Mode.

---

In 3-D Selection Mode, the cursor is a 3-D cursor made up of three lines parallel to the X, Y, and Z axes. In 2-D Selection Mode, the cursor is the familiar mouse arrow.

**Example: Select an object using a selection box.**

Make sure that your view windows are in the DesignCAD Tile default arrangement. (See the DESIGNCAD TILE command entry for details.) Draw an object on the screen. Next, choose 3-D SELECTION MODE and select the object with a 3-D selection box. Make sure the object is completely inside the selection box along all three axes before setting the second point.

**Hint:** To ensure that you are enclosing the entire object in all 3 dimensions, choose the DesignCAD Tile command to set up your main Perspective view and smaller Front, Top, and Side views. Move the cursor so that it appears outside the “bottom left” corner of the object to be selected in all three of the smaller views. (You may have to press **Ctrl+Shift** while moving the mouse to get there). Now press the left mouse button, hold it down, and move so that the cursor drags the selection box past the “top right” corner of the object in all three of the smaller views. Release the mouse button. If the selection box completely enclosed the object, it will be selected. (It takes some practice, so keep trying.)

---

**See Also:** *2-D Selection Mode*

Menu: HELP  
Menu Command: ABOUT DESIGNCAD

The About DesignCAD command displays information about the program, including the DesignCAD release date, who the program is registered to, and the serial number. The command also offers direct Internet links to technical support and the ViaGrafix home page on the World Wide Web. You can also find information about your computer system.

### Using the Command

Select the ABOUT DESIGNCAD command from the HELP menu. The About DesignCAD dialog box appears.



### Using Internet links

If you have a network or dial-up connection to the Internet and Web browser software installed, you can go directly to the ViaGrafix home page on the World Wide Web. Click the WEB SITE button in the About DesignCAD dialog box. This will start your browser and call up our Web page. The browser will automatically load the site's URL or address.

To go to our Technical Support page on the Web, click the TECH SUPPORT button in the About DesignCAD dialog box. A message box appears listing information you will need to provide for



our technical support staff.

If you need to visit our technical support Web site, click the WEB SITE button. Your browser will start and automatically load our support page's address.

### **Getting System Information**

DesignCAD can tell you some basic information about your computer system. Click the SYSTEM INFO button in the About DesignCAD display box. A message box appears with information about your operating system, memory and free space on your hard drives.

Menu: DIMENSION  
Submenu: INFO  
Menu Command: ANGLE & DISTANCE BETWEEN POINTS  
Point 1: First point to be calculated  
Point 2: Second point to be calculated

The Angle & Distance Between Points command calculates the angle and distance between two points and displays that information in a dialog box. You can then insert the measurements into your drawing. This command is only available in 2-D Mode.

## Using the Command

Choose the ANGLE & DISTANCE BETWEEN POINTS command. Set two points for the angle and distance to be measured. A box appears, showing the results, with the angle first and the distance second.

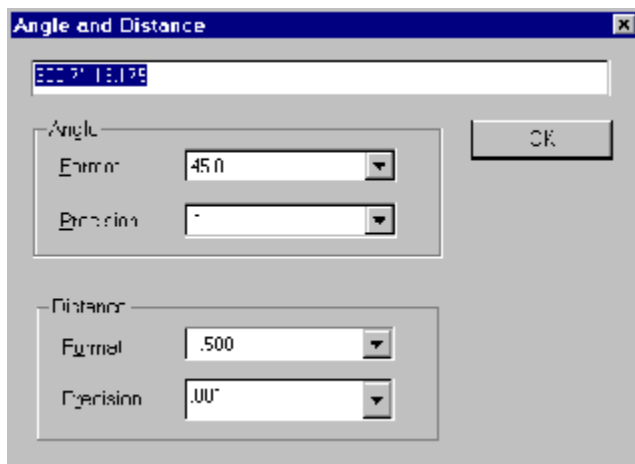

## Angle

### Format

This option changes how the measurement is displayed. DesignCAD lets you choose from the following format options:

- degrees
- grads
- radians
- degrees, minutes, seconds
- geographical angles

### Precision

This option lets you choose the degree of accuracy that DesignCAD uses to display the angle information.

## Distance

### Format

Use this option to select the format you want DesignCAD to use for displaying distance information. The following options are available:

- decimal
- fractional
- engineering
- architectural

#### Precision

This option lets you select the degree of accuracy that DesignCAD uses to display the distance information, in whole numbers or fractions.

**Hint:** DesignCAD lets you copy and paste the calculations into your drawing.

---

#### **Example: Calculate the angle and distance of two points and insert the result into a drawing.**

Choose the ANGLE & DISTANCE BETWEEN POINTS command. Set two points for the angle and distance to be measured. A box appears, giving the results of the calculation. Choose the FORMAT and PRECISION options you want.

Next, select the results of the calculation. Press **Ctrl+C** to copy the angle and distance to the Clipboard. Return to the drawing and choose the TEXT command. Move into the TEXT box in the Command Line by pressing the **Tab** key or by clicking there with the mouse. Now press **Ctrl+V** to paste the angle and distance of the points into the **TEXT** box.

Once you have pasted the results, you can enter the text as you normally would, by returning to the drawing and setting points where you want to place the text.

Menu: DIMENSION  
Submenu: INFO  
Menu Command: ANGLE BETWEEN TWO LINES

Point 1: The first line of the angle to be measured  
Point 2: The second line of the angle to be measured

The Angle Between Two Lines command measures the angle between two non-parallel lines and displays the result. This measurement can then be copied and pasted into a drawing (see Angle & Distance Between Points command).

### Using the Command

Choose the ANGLE BETWEEN TWO LINES command. Set a point on the first line of the angle to be measured. Set a point on the second line. The result is displayed in the Angle Between Two Lines dialog box.

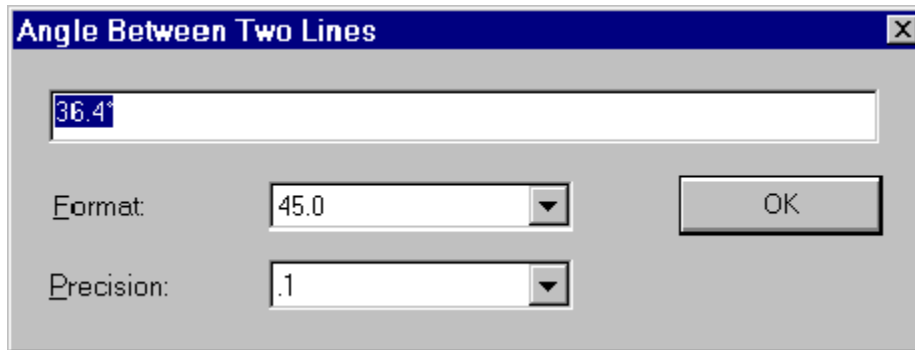

Click the OK button to close the dialog box.

### Angle Between Two Lines

#### Format

This option changes how the measurement is displayed. DesignCAD lets you choose from the following format options:

- degrees
- grads
- radians
- degrees, minutes, seconds

#### Precision

This option lets you choose the degree of accuracy that DesignCAD uses to display the angle information.

### Example: Calculate the angle between two lines.

Choose the ANGLE BETWEEN TWO LINES COMMAND. Set a point on each of the two lines to be used for calculating the angle. After the Angle Between Two Lines box appears, click on the FORMAT down arrow and choose one of the four options. Next, select the precision you want in the PRECISION box. DesignCAD immediately shows the result in the selected format and precision. Click the OK button to close the dialog box.



Menu: TOOLS  
Submenu: DIGITIZER  
Menu Command: ADD MENU ITEM  
Point 1: Point inside the menu area

The Add Menu Item command adds a command to an existing digitizer menu.

### **Using the Command**

Open the digitizer menu to be changed. Choose the ADD MENU ITEM command from the DIGITIZER submenu of the OPTIONS menu. Set a point in the area the new command is to occupy. The Digitizer Menu Command dialog box appears. Enter the name of the new command in the COMMAND box.

Click CONTINUE to add another command or DONE to close the dialog box.

***See Also: Close Digitizer Menu Command, Create Digitizer Menu Command, Load Digitizer Menu Command, Remove Menu Item Command, Save Digitizer Menu Command***

Menu: DRAW  
Submenu: ARC/ELLIPTICAL ARC  
Menu Command: ARC  
Shortcut Key: **A**

Toolbox Icon: 

Point 1: Center of the arc  
Point 2: Start of the arc  
Point 3: Orientation of the arc (optional)

The Arc command can be used to draw an arc which spans a given angle.

### Using the Command

Choose the ARC command from the Main Toolbox. Enter the arc angle in the ANGLE field in the Command Line. Finally use the mouse to specify a center point, a starting point, and an optional third point to orient the arc in 3-D space.

There are two choices for the format of the arc, which you can set in the Command Line:

- 1. Arc:** Stored as an actual arc in the drawing (default setting).
- 2. Save in vector form:** Draws line segments that follow the shape of an arc.



The Arc format saves the arc as an Arc entity. The Vector format saves the arc as a series of short line segments. You should normally use the Arc format because it is more efficient and precise. You can use the Vector format if you need to distort the arc by scaling or stretching.

### Example 1: Draw an arc in the XY plane with a radius of 10 and an angle of 60 degrees.

Change the view setting to the FRONT VIEW. Choose the ARC command and enter **60** degrees in the ANGLE box in the Command Line. Set a point anywhere on the screen for the arc's center. Choose the POINT RELATIVE command from the POINT menu or press the ' key (single quote), and enter **10** for DX. Set a third point anywhere on the screen with the mouse or arrow keys. Your arc should look like the one in the illustration below.

### Example 2: Create a 120-degree arc similar to the one in the figure.

Set the angle as described above, and place the points as shown in the illustration below.

### Example 3: Create a third arc at an angle of 60 degrees which is parallel to the XZ plane.

Set the angle as above. Set the center point, then a point for the radius. For the third point press the single quote key (') for the POINT RELATIVE command, and set DZ to **10**. In the Front view this arc appears to be a straight line. You will have to change to a different view to see it as an arc. In the Top view, this arc should look like the 60-degree arc in the illustration.

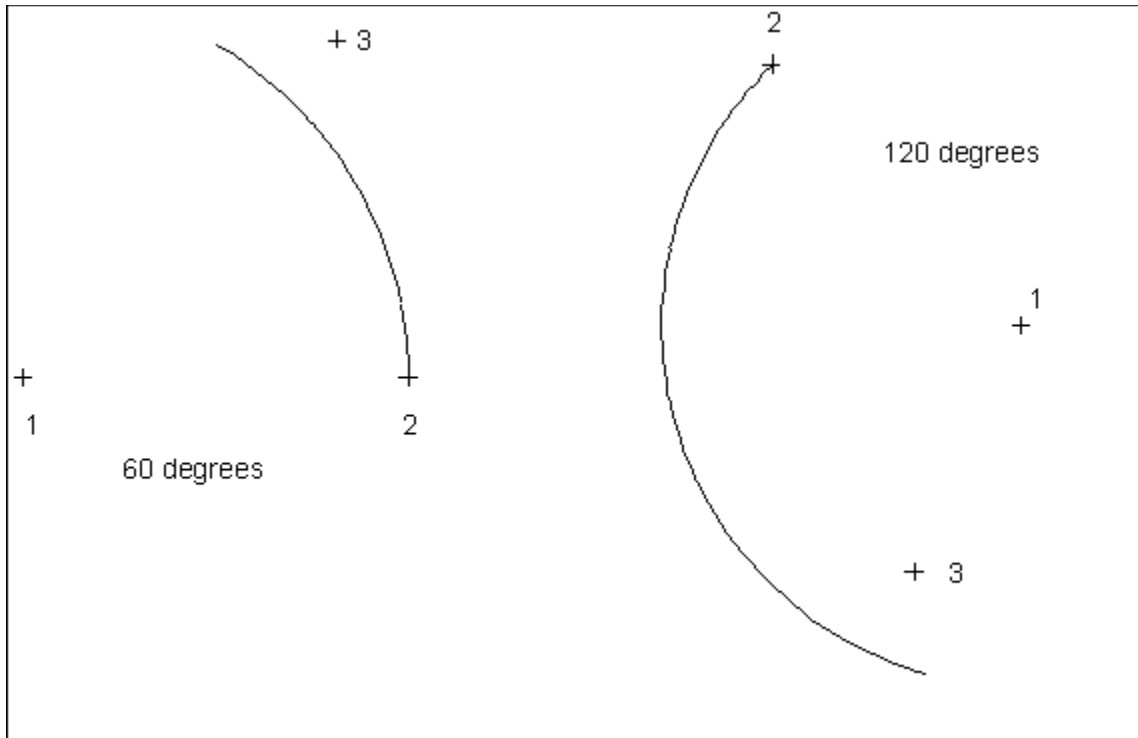

**See Also: Arc (3-Point) Command, Arc (Center, Begin, End) Command, Arc (Endpoints, Center) Command, Arc (Radius, Begin-End) Command, Tangent Arc Command**



Menu: DRAW  
Submenu: ARC/ELLIPTICAL ARC  
Menu Command: ARC (3-POINT)



Toolbox Icon:

Point 1: Beginning of the arc  
Point 2: A point along the arc  
Point 3: Endpoint of the arc

The Arc (3-Point) command draws an arc using a specified starting point, a second point through which the arc passes, and the endpoint of the arc.

### Using the Command

You have two choices for the format of the arc in the Command Line:

- 1. Arc:** Stored as an actual arc in the drawing (default setting).
- 2. Save in vector form:** Draws line segments that follow the shape of an arc.

Save in vector form

Click the Save in vector form box if you want to change the format from Arc to Vector. The program remembers your most recent selection the next time you use the Arc (3-Point) command.

The Arc format stores a center point, endpoint, and orientation point in the drawing. The Vector format stores a series of points for the line approximating the arc. You can draw arcs with this command in either a decreasing or increasing angular direction. This means that the arc can be drawn in either direction from its starting point.

### Example: Draw an arc passing through three points.

Select the ARC (3-POINT) command and set a point anywhere on the screen. Set a second point about an inch away (relative only to your screen) from the first in any direction. This point determines the direction that the arc is drawn. It is also a point on the arc. As you move the cursor notice that a rubber-band arc forms a representation of the arc using the cursor location as the endpoint. Set a third point for the end of the arc.

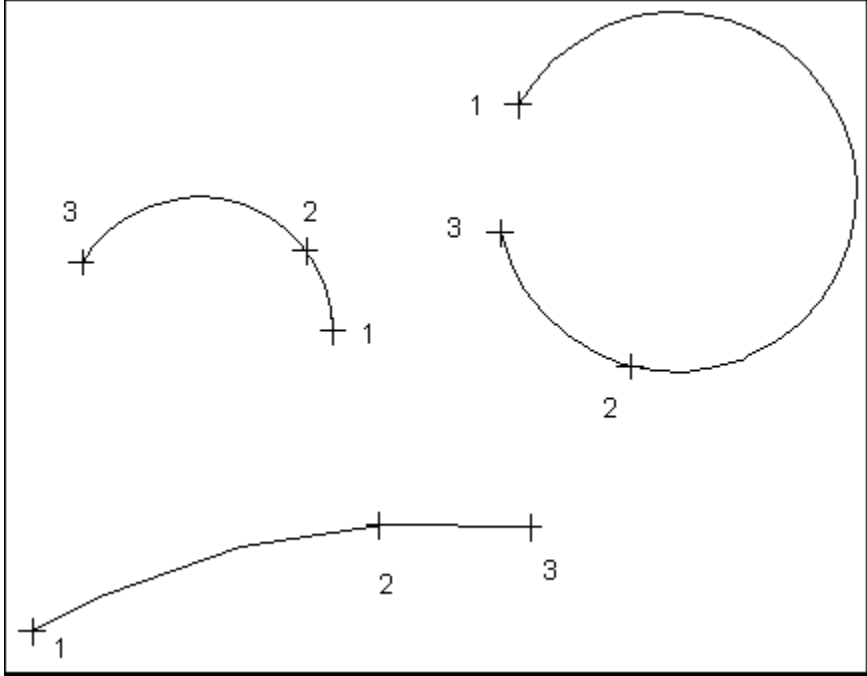

**See Also: Arc Command, Arc (Center, Begin, End) Command, Arc (Endpoints, Center) Command, Arc (Radius, Begin-End) Command, Tangent Arc Command**

Menu: DRAW  
Submenu: ARC/ELLIPTICAL ARC  
Menu Command: ARC (CENTER, BEGIN, END)



Toolbox Icon:

Point 1: Center of arc  
Point 2: Beginning of arc  
Point 3: End of arc

The Arc (Center, Begin, End) command can be used to draw an arc using the center, beginning, and end points of the arc.

### Using the Command

You have two choices for the format of the arc:

- 1. Arc:** Stored as an actual arc in the drawing (default setting).
- 2. Save in vector form:** Draws line segments that follow the shape of an arc.

Save in vector form

Use the Save in vector form box to change the format from Arc to Vector. The program retains the most recent selection each time you use the Arc (Center, Begin, End) command in the current drawing session.

The Arc format stores a center point, endpoint, and orientation point in the drawing. The Vector format stores a series of points for the line approximating the arc.

The first point you set becomes the center of the arc. The second point sets both the radius and the start angle of the arc. The third point sets the ending angle of the arc, and will not necessarily lie on the endpoint of the actual arc that is drawn.

**Note:** Arcs drawn with the Arc (Center, Begin, End) command are created in such a way that the arc can only span a positive angle from its starting point, so the arc will be drawn counterclockwise from point 2 to the span angle on the arc determined by point 3.

---

### Example: Draw an arc using a specific center point.

Select the ARC (CENTER, BEGIN, END) command and set a point for the center of the arc. Set a second point about an inch directly above the first point. As you move the cursor around the screen, a rubber-band arc forms a representation of the arc using the cursor position as the span angle. When the arc spans the angle you want, set the third point.

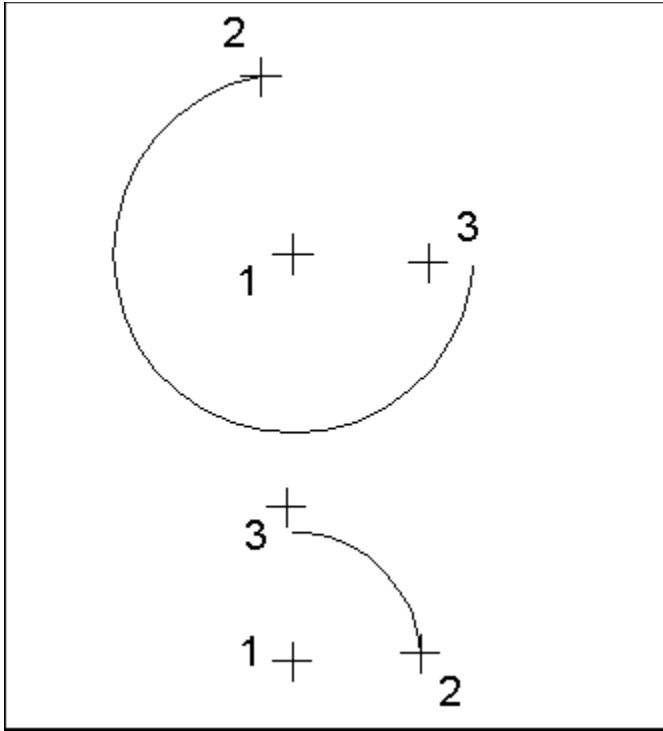

**See Also:** *Arc Command, Arc (3-Point) Command, Arc (Endpoints, Center) Command, Arc (Radius, Begin-End) Command, Tangent Arc Command*

Menu: DRAW  
Submenu: ARC/ELLIPTICAL ARC  
Menu Command: ARC (ENDPOINTS, CENTER)



Toolbox Icon:  
Point 1: Beginning of the arc  
Point 2: End of the arc  
Point 3: Center (radius) of the arc

The Arc (Endpoints, Center) command draws an arc using points set for the beginning, end, and radius of the arc. This command is similar to the Arc (Radius, Begin-End) command except the radius is determined by the third point rather than by entering a radius in the Command Line.

### Using the Command

You have two choices for the format of the arc:

- 1. Arc:** Stored as an actual arc in the drawing (default setting).
- 2. Save in vector form:** Draws line segments that follow the shape of an arc.

Save in vector form

Use the Save in vector form box to change the format from arc to vector. The program retains the most recent selection each time you use the Arc (Endpoints, Center) command in the current drawing session.

The Arc format stores a center point, endpoint, and orientation point in the drawing. The Vector format stores a series of points for the line approximating the arc.

The first point determines the beginning of the arc. The second point defines the end of the arc. After the second point is set, a rubber-band arc shows how the arc will be drawn. Set a third point for the center of the arc. An arc is then drawn counterclockwise from the first point to the second point.

### Example: Draw an arc with a point set for the radius.

Select the ARC (ENDPOINTS, CENTER) command. Set a point for the beginning of the arc on the right side of the screen. Set a second point for the end of the arc on the left side of the screen. After this point is set, a rubber-band arc will be drawn as the cursor is moved. Set a third point for the radius in the center of the screen, below the first two points. An arc will be drawn from the first point to the second point, using the third point to determine the radius.

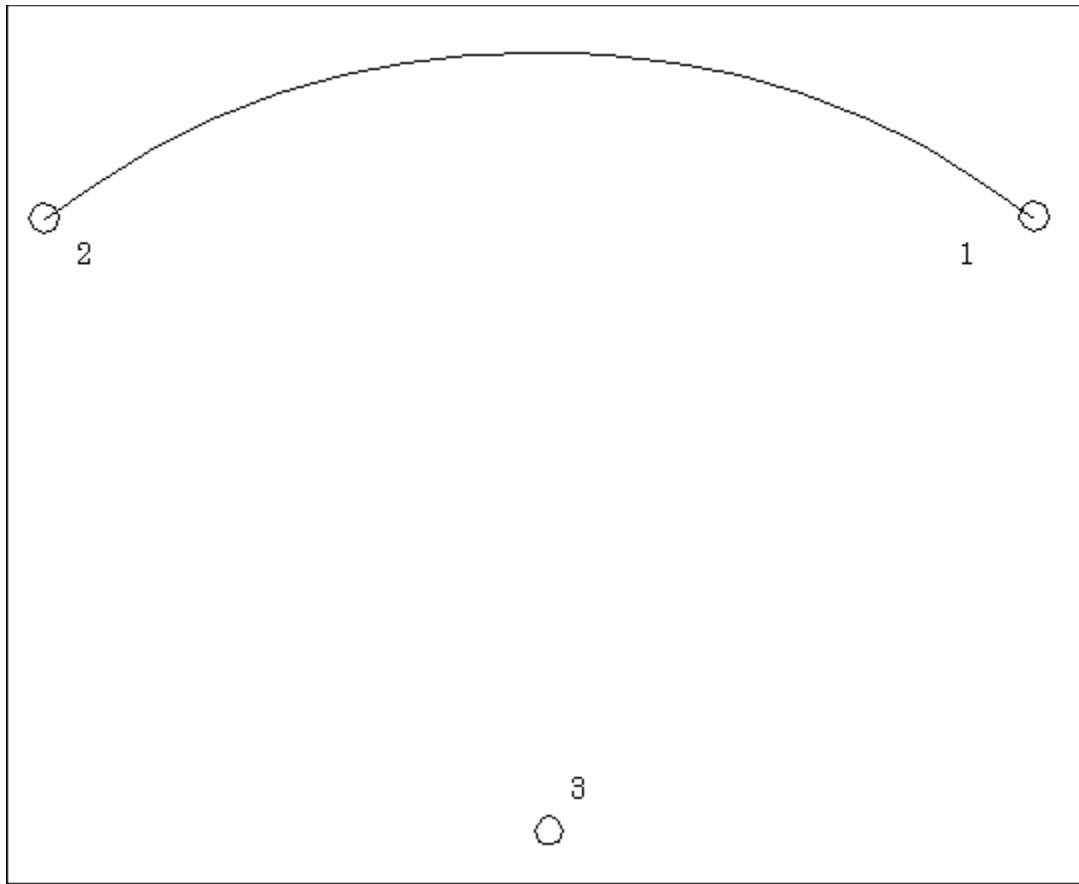

**See Also: Arc Command, Arc (3-Point) Command, Arc (Center, Begin, End) Command, Arc (Radius, Begin-End) Command, Tangent Arc Command**

Menu: DRAW  
Submenu: ARC/ELLIPTICAL ARC  
Menu Command: ARC (RADIUS, BEGIN-END)



Toolbox Icon:  
Point 1: Start of arc  
Point 2: End of arc  
Point 3: Orientation

The Arc (Radius, Begin-End) command can be used to draw an arc of pre-determined radius by specifying the beginning and ending points of the arc and setting an optional third point to orient the arc in 3-D space.

### Using the Command

Like the Arc command, the Arc (Radius, Begin-End) command offers two choices for the format of the arc:

- 1. Arc:** Stored as an actual arc in the drawing (default setting).
- 2. Save in vector form:** Draws line segments that follow the shape of an arc.



The Save in vector form box in the Command Line is used to change the format from Arc to Vector. The desired radius is entered in the RADIUS box. The settings you choose will be used as the default settings for that command in the current drawing until you reset them.

The Arc format stores a center point, endpoint, and orientation point in the drawing. The Vector format stores a series of points for the line approximating the arc.

The Arc (Radius, Begin-End) command automatically creates an arc with a span of less than 180 degrees, the smallest possible arc based on the supplied radius and the first two points set. To create an arc with a span greater than 180 degrees, set the third point inside the area enclosed by the rubber-band arc and the first two points. The arc is drawn in an increasing angular direction from the first point to the second.

### Example: Create an arc with a radius of 20.

Select the ARC (Radius, Begin-End) command. Enter the RADIUS as **20** in the Command Line. Set a point somewhere around the center of the screen. Move the cursor up and to the right a couple of inches and set a second point. Now, move the cursor between the two points. Notice that DesignCAD forms a rubber-band arc. Set a third point to insert the arc into your drawing.

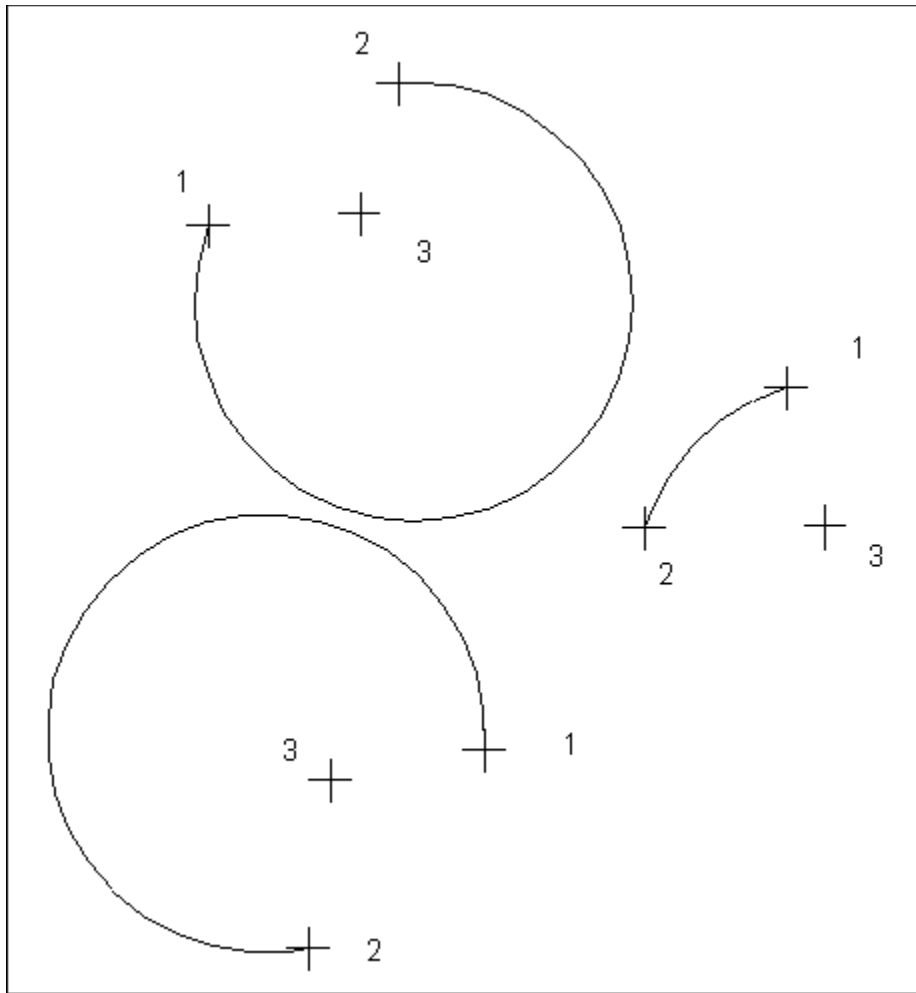

**See Also: Arc Command, Arc (3-Point) Command, Arc (Center, Begin, End) Command, Arc (Endpoints, Center) Command, Tangent Arc Command**



Menu: DIMENSION  
Submenu: INFO  
Menu Command: AREA  
Points: Determine the area to be calculated

The Area command calculates the area of part of a drawing and displays the results in a dialog box. This information can be inserted into the drawing.

### Using the Command

To use the command, select the AREA command from the INFO submenu of the DIMENSION menu. Then set points around the area you want to measure. The points will be connected with a temporary line. The area of the shape will be calculated and displayed on the screen.

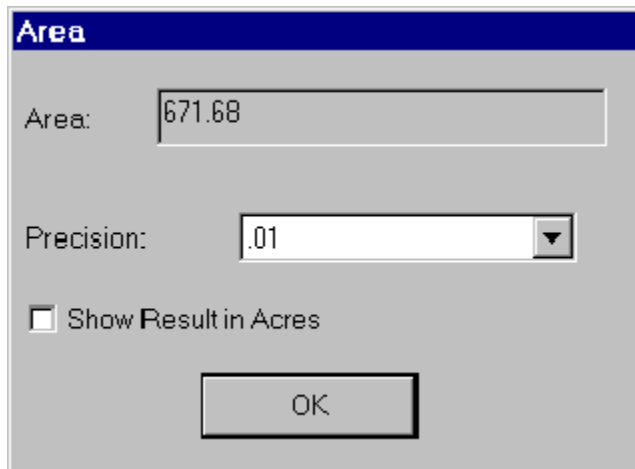

The area is calculated using the current Drawing Units. If the first and last points are not in the same location, an imaginary line connects those two points to close the shape.

#### Show Results in Acres

Select the SHOW RESULTS IN ACRES box if you want DesignCAD to calculate the area in acres instead of Drawing Units.

#### Precision

Click the down arrow in the PRECISION box to change how precisely DesignCAD displays the information. You can set the accuracy to round the result anywhere from the nearest 10 millions to the nearest 10 millionths.

### Inserting Area into a Drawing

In the AREA box, highlight the area text. Press **Ctrl+C** to copy the text to the Clipboard.



Next, click the OK button. Choose the TEXT 2-D command from the Main Toolbox. Click in or **Tab** into the TEXT box in the Command Line. Press **Ctrl+V** to paste the Clipboard contents. Set the points for the text.

**Example: Calculate the area of a box and insert the figure into the drawing.**

Draw a box. Select the AREA command from the INFO submenu of the DIMENSION menu. Set points on the corners of the box. After the first point is set, a rubber-band line shows the area to be calculated. Press **Enter**. An information box shows the area of the box in Drawing Units.

In the AREA dialog box, highlight the area text. Press **Ctrl+C** to copy the text to the Clipboard. Click the OK button and choose the TEXT 2-D command. Click in or **Tab** into the TEXT box in the Command Line. Press **Ctrl+V** to paste the Clipboard contents. Place the text as you normally would, by setting points in the drawing for the text.

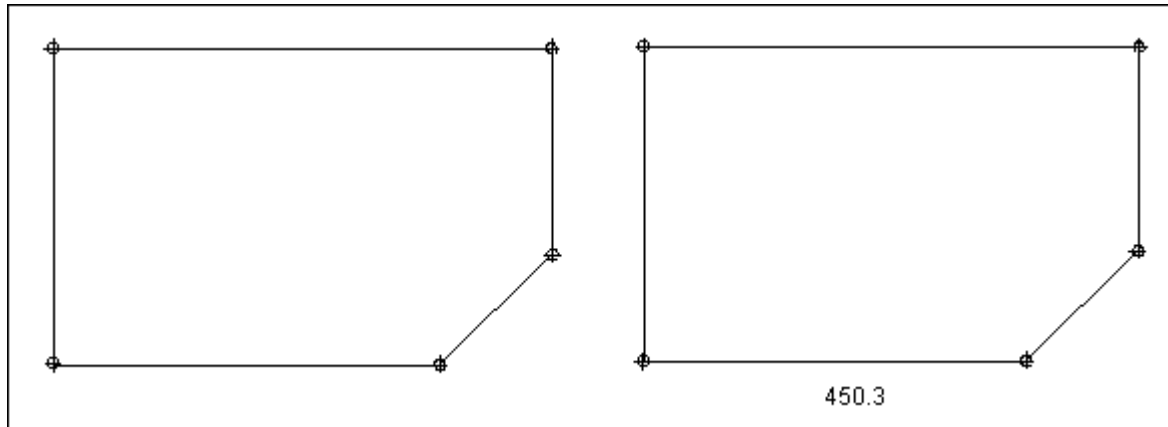

Menu: WINDOW  
Menu Command: ARRANGE ICONS

The Arrange Icons command organizes the view icons at the bottom of the window.

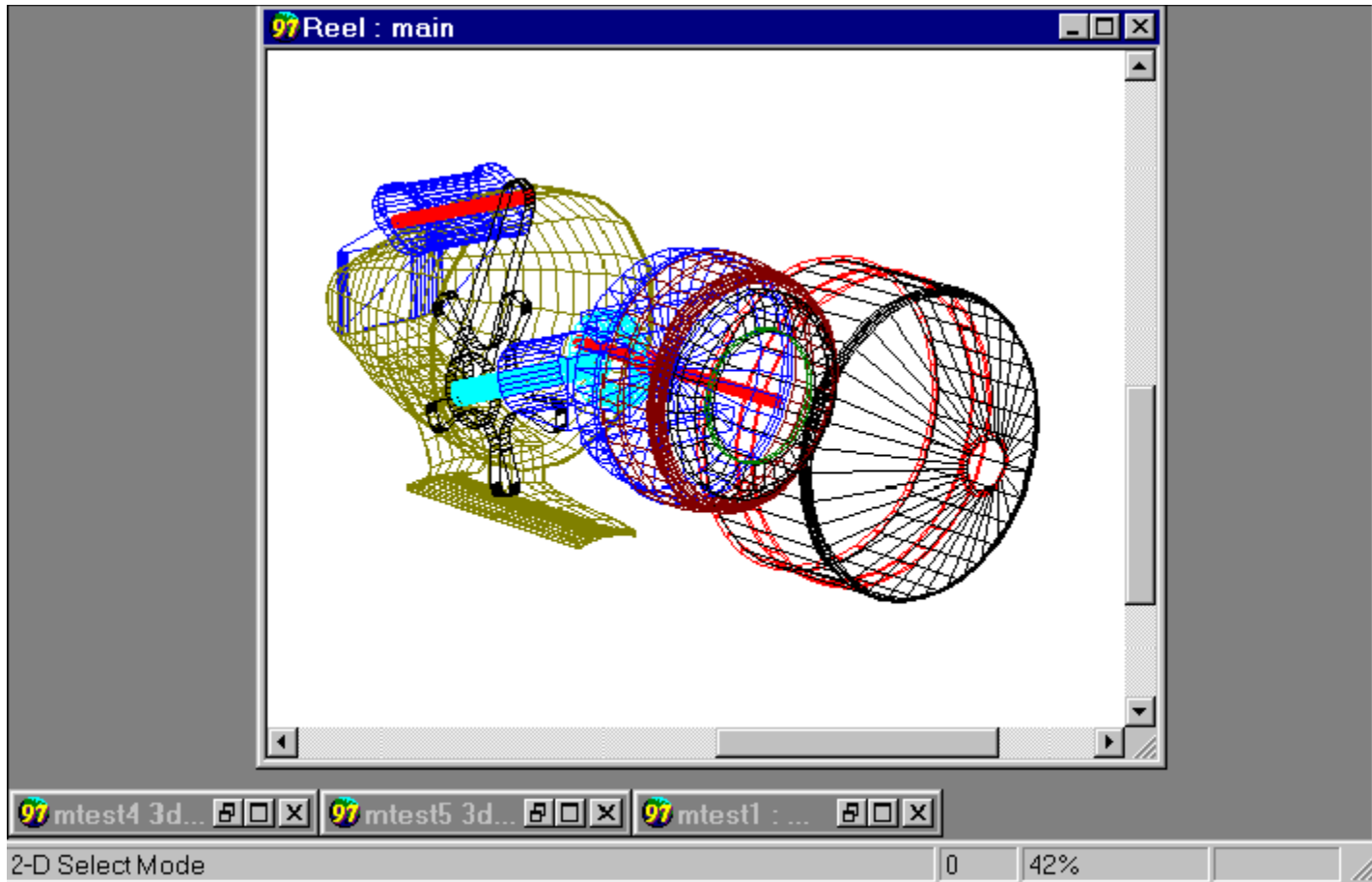

### Using the Command

Any viewing window in DesignCAD 97 can be minimized, maximized, or sized. If you have minimized several view windows into icons, you can arrange them at the bottom of the drawing screen. Choose the ARRANGE ICONS command from the WINDOW menu. The icons are automatically arranged.

Menu: DRAW  
Menu Command: ARRAY



Toolbox Icon:

Point 1: Location and direction of first copy (relative to handle)  
Point 2: Axis of Direction 2 (relative to handle on the original)  
Point 3: Axis of Direction 3 (relative to handle on the original)

The Array command copies a selected object a specified number of times in as many as three directions. The object you want to copy must be selected before you use this command.

### Using the Command

The Array command can make multiple copies of an object in a one dimension (in a single row), in two dimensions (rows and columns), or in three dimensions (rows, columns, and layers).

To copy in a single direction or dimension, enter the number of copies in DIRECTION 1, and enter **1** for DIRECTION 2 and DIRECTION 3. Set a point for the location of the second copy of the object. (The first copy is the original.) The copy is positioned so that the point that corresponds to the selection handle on the original is located on that point. Subsequent copies are placed at the same direction and distance as the first point from the selection handle of the original. In other words, all copies are evenly spaced based on the spacing of the first two copies.

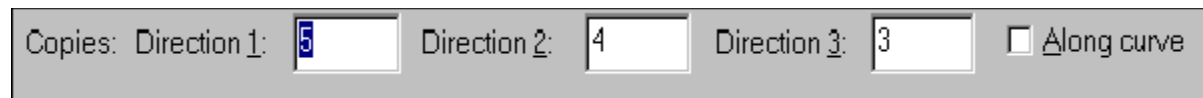

The Array command can also make copies in two dimensions—rows and columns. To do this, enter the number of columns in DIRECTION 1, and the number of rows in DIRECTION 2. Leave DIRECTION 3 set to **1**. Set a point for the offset (the distance and direction) of copies in the first row. Then set a second point for the offset of the rows themselves. For example, you might want to set the first point to the right of the selection handle, and the second point directly above the selection handle.

To make a three-dimensional array with this command, add the number of "layers" of rows and columns in DIRECTION 3, and add a third point for the offset of each layer.

### Along Curve

The Array command can also draw an array along a curve. To draw an array along a curve, check the ALONG CURVE box in the Command Line. An additional option is added to the Command Line: Perpendicular. Check the Perpendicular box to draw the objects in the array perpendicular to the curve.

To specify exactly what is set perpendicular to the curve, it is necessary to set three selection handles for the object to be arrayed. If a plane were drawn using the three selection handles as points, the plane is what would be set perpendicular to the curve.

Set the number of copies to be drawn along the curve in the DIRECTION 1: box in the Command Line. Set a point on the curve the array is to be drawn along.

**Hint:** The easiest way to set the point on the curve for the array is to use the Gravity command to snap to one of the endpoints of the curve.

---

**Example: Make two rows of two copies of a box, in three dimensions.**

Select the box and choose the ARRAY command. Enter **2** for each direction (DIRECTION 1, DIRECTION 2, and DIRECTION 3). Set a point directly to the right of the selection handle, and a second point above it. Finally, set a point on the third axis, away from the handle on the original box. The box will be duplicated in a 2 x 2 x 2 formation.

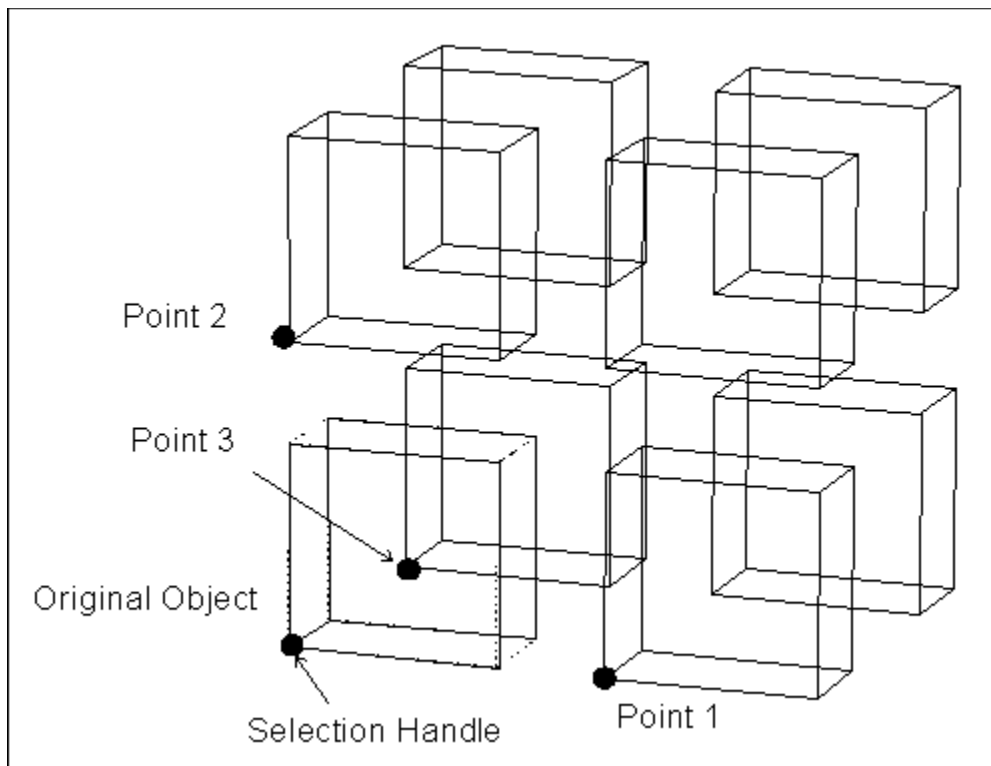

Menu: DRAW  
Submenu: LINE  
Menu Command: ARROW  
Shortcut Key: >



Toolbox Icon:

Point 1-n: Body of the arrow  
Point n: Arrowhead

The Arrow command draws an arrow using two or more points.

### Using the Command

Set the first point at the tail and work toward the arrowhead. Use the options in the Command Line to set the arrowhead size and style.

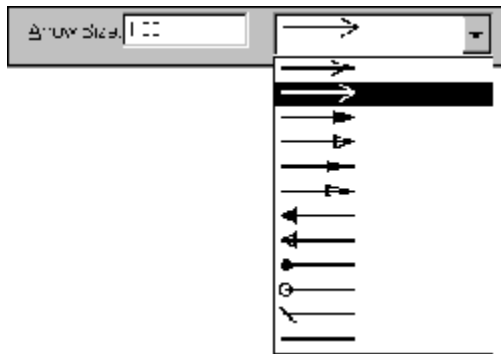

### Example: Draw an arrow.

Select the ARROW command and set **1** for the ARROW SIZE option in the Command Line. Select the arrow type. Set a point for the tail of the arrow and two points for the body of the arrow, so that they form a right angle. Press ENTER to draw the arrow.

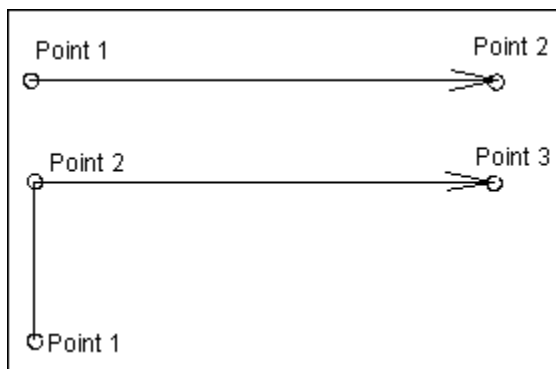

Menu: DRAW  
Menu Command: ATTRIBUTE  
Shortcut Key: \$

Toolbox Icon: 

Point 1: Location of the attribute

The Attribute command is used to assign information to objects in the drawing. Later you can use the Material List command to list the types and numbers of attributes you have placed in your drawing.

### Using the Command

Select the ATTRIBUTE command. Enter the information in the TEXT field in the Command Line.



Click on the  button to open the Text Option dialog box.

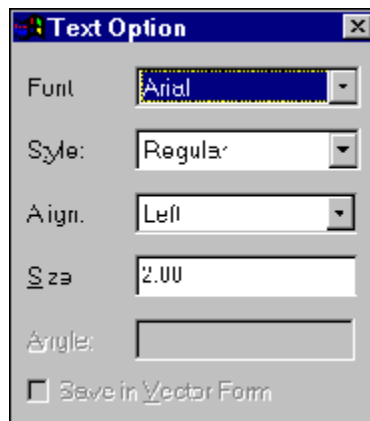

In the Text Option box, choose the font, style (**bold**, *italic*, **both**, or neither), alignment (left, right, or centered), and specify the text size for the attribute. The text angle for attributes is fixed at zero. Attributes are always stored as 2-D text.

The SAME AS control  in the Command Line lets you match the parameters of an existing attribute or piece of text. Just click on the SAME AS button, then click on the attribute already in the drawing that has the font, style, alignment, and size that you want for the new attribute. Make sure you have entered the text for the new attribute in the TEXT: box in the Command Line and then set a point for the location of the new attribute.

Click the TEXT INSERT button  to display the Text Insert box.

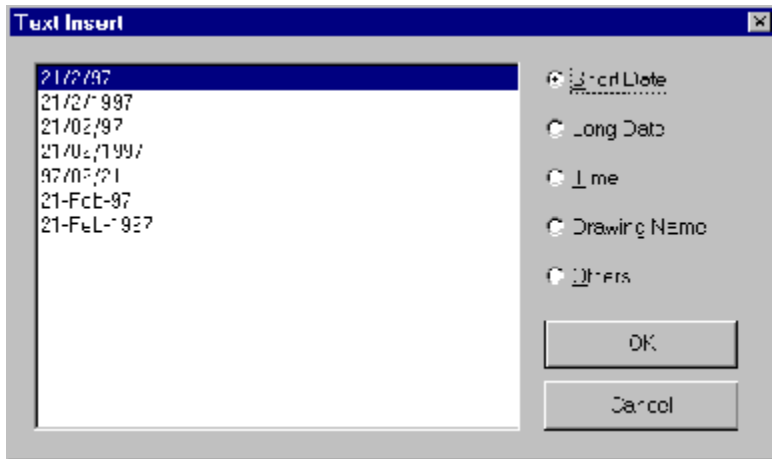

Choose the kind of text you would like to have automatically inserted from the list of items to the right of the Text Insert dialog main window: Short Date for example. Using the mouse, click the format for the item from those displayed in the main window of the Text Insert dialog and then click the OK button.

Attributes can be made visible or invisible by checking or unchecking the SHOW ATTRIBUTES option in the TEXT OPTIONS folder, available through the OPTIONS command in the OPTIONS menu. Leaving Attributes hidden makes working on your drawing easier.

**Example: Label an object in your drawing.**

Make sure that the Show Attributes option in the Text Options folder has a check next to it, showing that it is enabled. Select the ATTRIBUTE command. Click in TEXT: box in the Command Line and enter a name for the object. Leave all of the other settings in the Command Line as they are. As you move the cursor, notice the green box following the cursor. This represents the area the text will occupy. Set a point near the object. The attribute is inserted at that point.



Menu: TOOLS  
Menu Command: AUTO TRACE BITMAP

The Auto Trace Bitmap command creates vector outlines of specified colors in bitmaps. This allows the image to be manipulated in DesignCAD. With a color or black and white scanner, a drawing or other art can be scanned and saved as a bitmap, then each color can be traced to produce a DesignCAD drawing.

### Using the Command

Bring a bitmap into DesignCAD with the LOAD IMAGE FILE command. When the bitmap is displayed, select it and choose the AUTO TRACE BITMAP command from the TOOLS menu. The Auto Trace Bitmap dialog box appears.

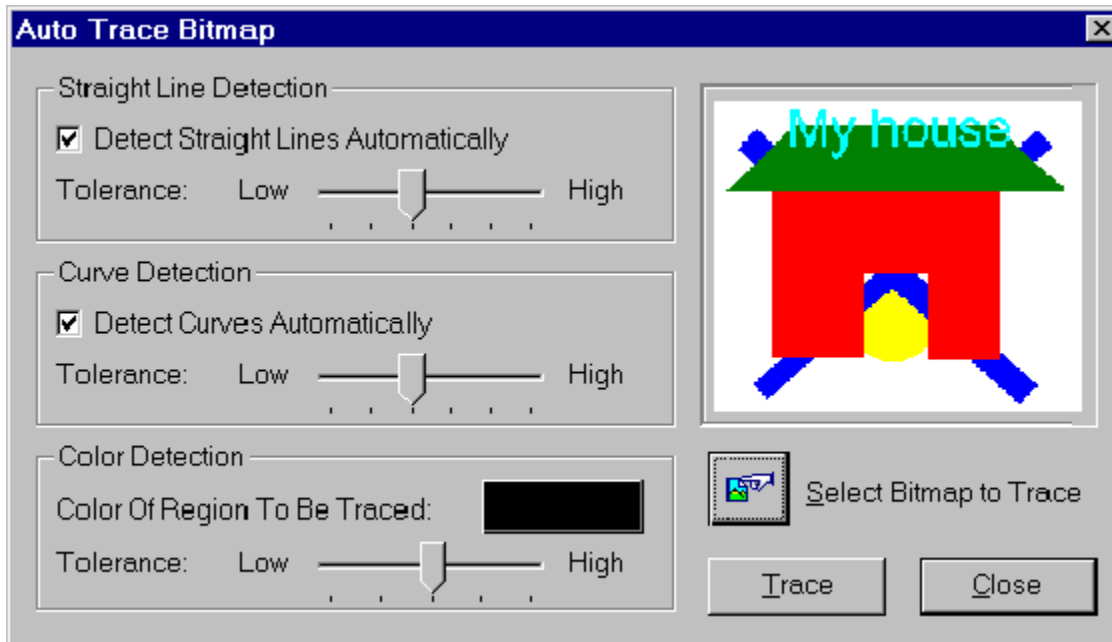

Select the DETECT STRAIGHT LINES AUTOMATICALLY option or the DETECT CURVES AUTOMATICALLY option or both by clicking on the check box(es). The Straight Line option detects straight lines and smoothes the resulting vectors by removing intermediate points. The Curves option deletes curves in the bitmap and smoothes the result by drawing fewer points to represent them.

Also, notice the Tolerance slider bars for the Straight Line Detection and Curve Detection. To change the tolerance for Straight Line or Curve Detection, click and hold the indicator using the mouse, then move the indicator closer to LOW or HIGH to change the tolerance.

For both the Detect Straight Lines Automatically option and the Detect Curves Automatically option a low tolerance results in short line segments. Conversely, a high tolerance for these options results in longer line segments.

In the Color Detection area of the Auto Trace Bitmap dialog box, the color to be traced is displayed on the Color of Region to Be Traced: button. To change color, click this button. The cursor turns into an eyedropper that has a small box at its tip.

Either in the thumbnail image at upper-right of the dialog box or in the main drawing area,

position the eyedropper on the item you want to trace. Click the mouse button. The sample is taken from inside the box at the eyedropper tip. The Color of Region to Be Traced: button will change to the color of the item you selected.

To change the tolerance for the color to be traced, click and hold the indicator using the mouse, then move the indicator closer to LOW or HIGH to change the tolerance. Changing the tolerance for the color to be traced, changes the size of the sample or "footprint" that will be taken when you select the color to be traced. All of the colors that fall within the footprint are considered a single color.

The Low setting on the Tolerance slider bar for Color Detection will take a 1 pixel sample. The next mark to the right takes a 2-pixel sample, the next a 4, the next a 6, and finally the High setting takes an 8-pixel sample. When you select a new color to be traced the box at the tip of the eyedropper is smaller or larger depending on whether you made the tolerance lower or higher.

If there are multiple bitmaps in the drawing, you can click the SELECT BITMAP TO TRACE button, then click on the bitmap you wish to trace.

Once you have selected the bitmap to be traced and set all of the tolerances to the desired levels, click the TRACE button. DesignCAD will trace the bitmap. If you like the results, click the CLOSE button to close the Auto Trace Bitmap dialog box.

If you do not like the result, use the mouse to click anywhere in the drawing and press Ctrl+Z for the Undo command. Change the tolerances and click the TRACE button again.

Once you are satisfied with the result, select the bitmap and delete it. The new vector image of the bitmap remains in the drawing.

**Note:** Auto Trace Bitmap can only trace and convert one color at a time. If the bitmap image has entities in more than one color, you must execute the Auto Trace Bitmap command for each colored item you want traced.

---

***See Also: Load Image File Command, Scan Image Command***

Menu: DIMENSION  
Submenu: INFO...  
Menu Command: BALLOON



Toolbox Icon:

Point 1: Point of arrowhead

Points 2 - n: Points along arrow. Last point is center of balloon.

The Balloon command draws a text balloon pointing to a specific object. It is useful for identifying part numbers or item numbers in diagrams. You may specify the size of the balloon and the text to include; the text is sized to fit inside the balloon.

### Using the Command

Choose the BALLOON command from the INFO submenu in the DIMENSION menu. Enter the desired text and balloon size in the command line. Click on the arrowhead button for a choice of arrow styles or to change the size of the arrowhead.

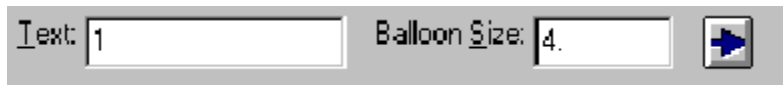

The SAME AS control in the Command Line lets you match the parameters of an existing balloon. Just click on the SAME AS button, then click on the balloon already in the drawing that has the properties you want for the new balloon.

Set a point for the tip of the arrowhead, and one or more points for the body of the arrow. The last point set is used as the center of the balloon.

#### **Example: Draw a balloon marking a box as item 1.**

Choose the BALLOON command from the INFO submenu of the DIMENSION menu. Enter the TEXT: and BALLOON SIZE. Set the first point at a corner of the box. Set point 2 for the bend in the arrow, and point 3 for the text location. Press **Enter** to end the command.

3  
□      2  
□

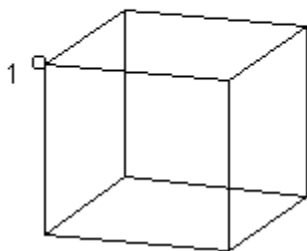

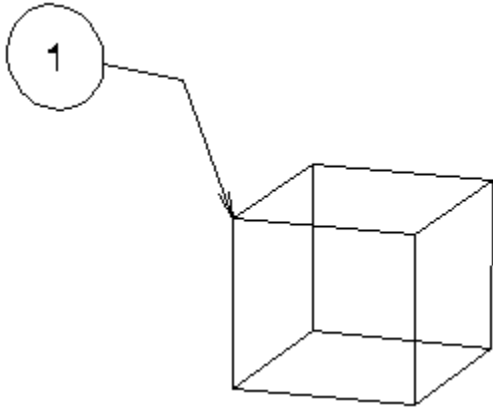

***See Also: Arrow Command, Pullout Command***

Menu: DIMENSION  
Submenu: INFO...  
Menu Command: BEARING



Toolbox Icon:  
Point 1: First point of the distance to be measured  
Point 2: Second point of the distance to be measured  
Point 3: Insertion point for the text

The Bearing command measures an object's bearings and inserts them into a drawing. This command is only available in 2-D Mode.

### Using the Command

Choose the BEARING command from the Main Toolbox. Set a point at the one end of the distance to be measured. Set a second point at the opposite end of the distance. The bearing text is placed in the text box of the Command Line and a rubber-band box appears at the text insertion point.

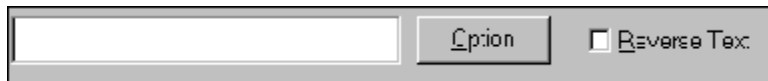

Click the OPTION button in the Command Line to change options for the bearing text.

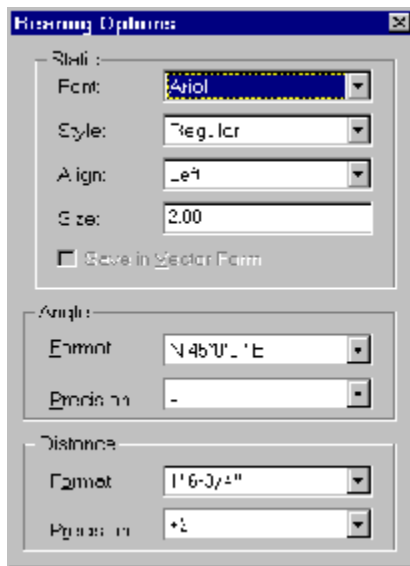

Set the desired options and press **Enter** to close the box. Position the rubber-band box where you want the text and set a final point.

**Note:** If you are measuring from the right side of the drawing window to the left the text will be inserted upside-down, so click the Reverse Text checkbox in the Command Line to reorient the text (insert it right-side-up).

---

### Example: Measure and insert the bearings of a line.

Choose the BEARING command. Move the cursor close to the right endpoint of the line and right-

click the mouse to set a Gravity Point. Move the cursor to the left endpoint of the line and right-click the mouse to set a second Gravity Point. Click the OPTION button in the Command Line to display the BEARING OPTIONS box. Set the options desired and press **Enter** to close the Bearing Options box. Click the REVERSE TEXT checkbox in the Command Line. Position the rubber-band box and set a final point to insert the bearing text.

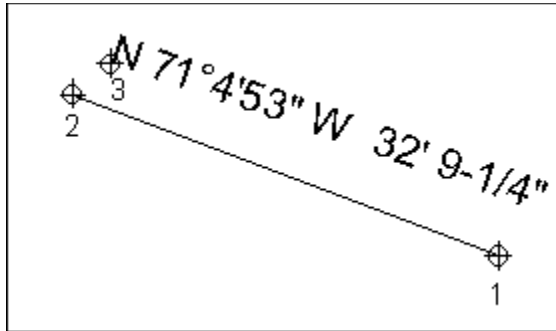

Menu: DRAW  
Submenu: LINES  
Menu Command: BEZIER CURVE



Toolbox Icon:

- Point 1: Beginning of the Bezier curve
- Point 2: First control point for the curve (beginning tangent)
- Point 3: Pass-through point
- Point 4: Second control point (tangent for point 3)
- Point 5: Pass through point (optional)
- Point 6: Third control point (tangent for point 5)
- Point 7-n: (Optional points in pairs)

The Bezier Curve command draws a Bezier curve.

### Using the Command

The first point is the endpoint of the curve, and the second point is the control point. The curve at the first point will be tangent to the second point. The third point is the end point, and the fourth point is the tangent. Each subsequent pair of points is a point for the curve to pass through and a control point to define the tangent at that location.

Moving a control point further from the curve makes the curve sharper. Points must be set in pairs. If you set an odd number of points, the last point is ignored.

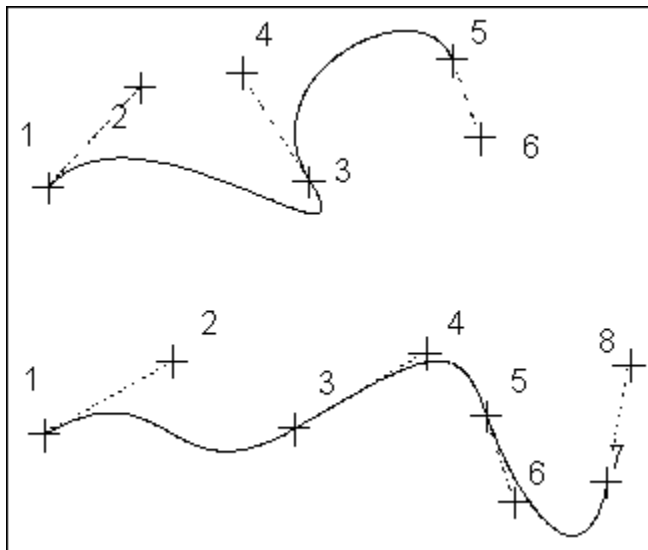

Menu: SOLIDS  
Menu Command: BOX  
Shortcut Key: ]



Toolbox Icon:

Point 1: First corner of the box  
Point 2: Opposite corner of the box

This command draws a 2-D or a 3-D box. A 2-D box is defined as a Plane. A 3-D box is defined as a Solid.

### Using the Command

For a 2-D box set a point for a corner of the box. A rubber-band box shows how the box will be drawn. Set a second point for the opposite corner.

To draw a 3-D box, set a point for one corner of the box. Move the cursor until the opposite corner of the box is where you want to place it. Then hold down the **Ctrl+Shift** keys and move the cursor in or out on the third axis. Set the second point when the box is in position.

### Example: Add a 3-D box to your drawing.

Select the BOX command and set a point for one corner of the box. Move the cursor up and to the right of the first one, noticing the rubber-band square being drawn. When the square is the size you want, move the cursor out along the Z-axis by holding down **Ctrl+Shift** and moving the mouse up. The square turns into a 3-D box. When it's as deep as you want, set the second point to draw the box.

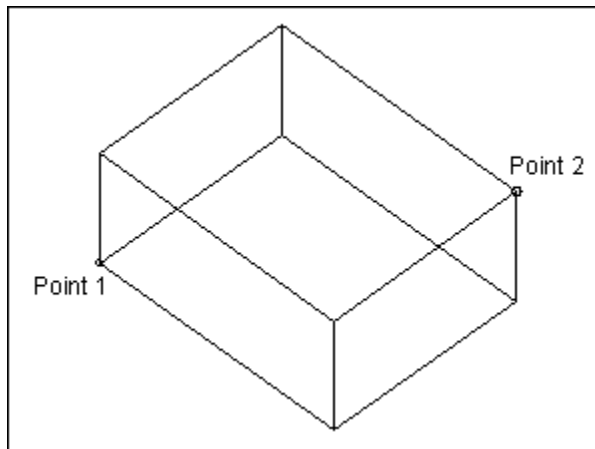



Menu: EDIT  
Submenu: SELECTION  
Menu Command: BREAK LINE  
Shortcut Key: |

The Break Line command breaks a line entity consisting of two or more line segments into separate line entities.

### **Using the Command**

Select the entity (or entities) to be broken. Choose the BREAK LINE command with the shortcut key (|), or from the EDIT | SELECTION menu. You can use the command on a line created with the Line or Polygon commands, or created with Arcs, Circles, or Curves saved as vectors. The line selected will be broken into several separate lines, depending on how many vertices the line has. The line looks the same but is actually made of separate line entities.

### **Example: Break apart an object made up of two or more line segments.**

Select the object. Press the | key to select the BREAK LINE command. Although the object looks the same, it's now broken into separate entities.

Menu: DIMENSION  
Menu Command: CALCULATOR

The Calculator command allows you to perform calculations on the screen. Once the computation is made, you can copy the result and paste it into a drawing.

### Using the Command

Choose the CALCULATOR command. The DesignCAD Calculator window appears. In the calculation box enter the values and operators for the calculation. Then press Enter or click on the COMPUTE button. DesignCAD makes the calculation and displays it in the box. Click the CLOSE button to end the command.

The expression entered in the calculation box can contain a formula or expression. The following are examples of valid expressions:

45\*23

(6+23)\*4

SQRT(9)

SIN(45)

The expression can contain mathematical functions and the following operators:

- + Addition
- Subtraction
- \* Multiplication
- / Division
- ^ Raises a number to a power ( $2^3 = 8$ )

### Inserting a Calculation into a Drawing

Select the text in the calculation box if it is not already selected. Press **Ctrl+C** to copy the text to the Clipboard. Click the CLOSE button to return to your drawing.

Next, choose the PASTE command. As soon as you do, a rubber-band text box appears, showing how the text will be inserted. Set a point for the lower-left corner of the text. The text is inserted into the drawing.

You can also insert the results of a calculation into a drawing by using one of the text commands which allow you to change the font, style, alignment, size, and angle. First, copy the text from the calculation box to the clipboard. Next, choose the TEXT command. Move the cursor to the TEXT box in the Command Line. Press **Ctrl+V** to paste the contents of the clipboard into the box. Set the other options as desired. Finally, return to the drawing and set the points for the

text. The result of the calculation is inserted into the drawing.

**Example: Find the log of 18.**

Choose the CALCULATOR command. Enter **log(18)** in the calculation box in the DesignCAD Calculator window. Press the **Enter** key or the COMPUTE button. The result, 1.26, is displayed in the box.

Menu: WINDOW  
Menu Command: CASCADE

The Cascade command arranges open drawing windows so that they overlap on the screen.

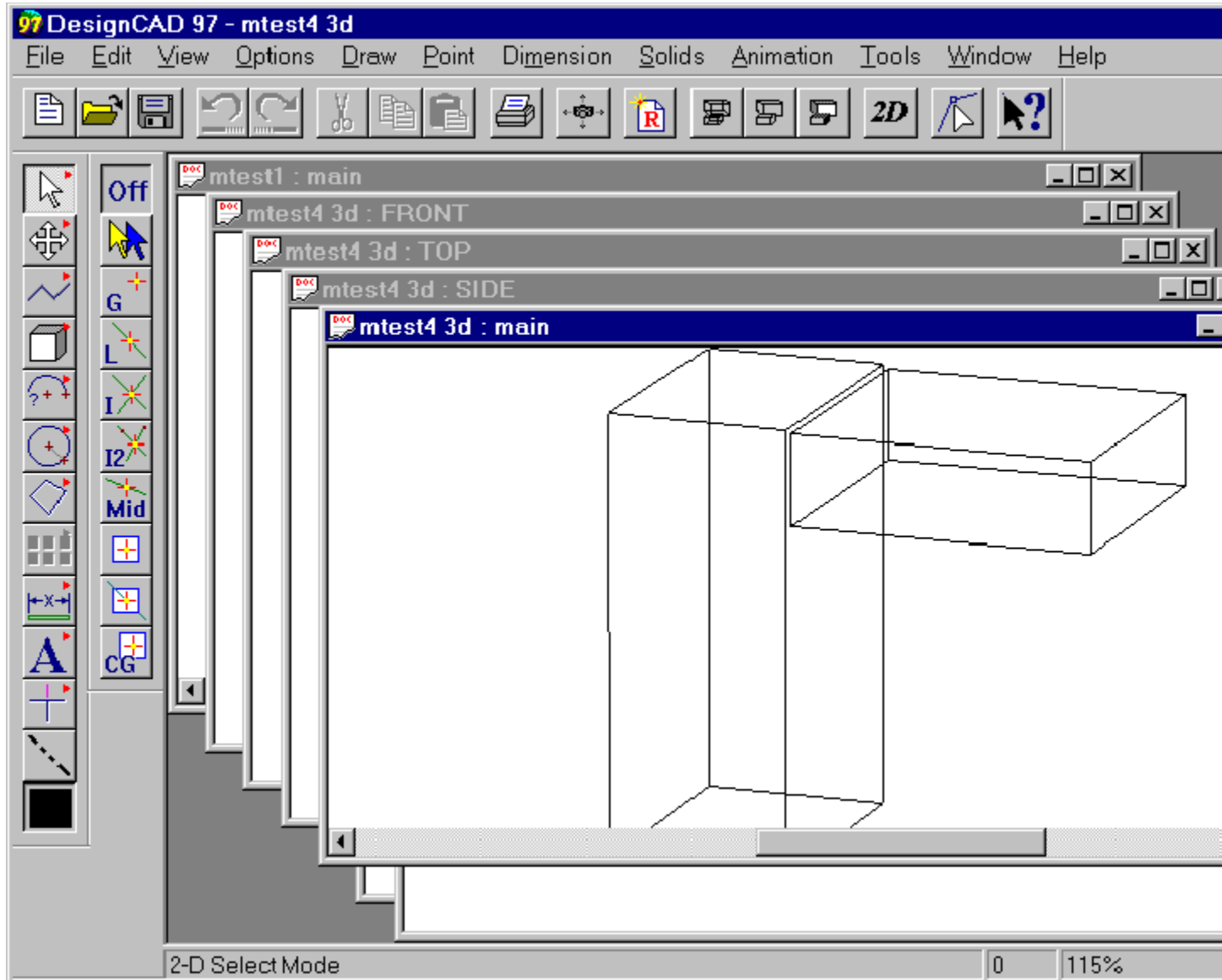

### Using the Command

Choose the CASCADE command in the WINDOW menu. All open drawing windows are arranged on the screen.

**See Also:** *Tile Vertical Command, Tile Horizontal Command, DesignCAD Tile Command*

Menu: POINT  
Menu Command: CENTER OF GRAVITY

Toolbox Icon: 

Point 1: Point on the object

This command finds an object's center of gravity. For example, you can use the Center of Gravity command to find the volumetric center of complex solids. This command is also useful for finding the geometric center of a plane.

### Using the Command

To use the Center of Gravity command, select it from the POINT menu. Then set a point on or near the object. The cursor snaps to the object's center of gravity.

---

**Note:** If you select the Center of Gravity command from the Point menu, it will always set a point.

If the Move Cursor Only  button is "pushed in" on the Snap Toolbox and you select the command from the Snap Toolbox instead of from the menu the command will just move to the position instead of setting a point there.

---

### Example: Find the center of gravity of a solid.

Select the CENTER OF GRAVITY command from the menu. Click somewhere on the solid. The cursor sets a point at the exact center of the solid.

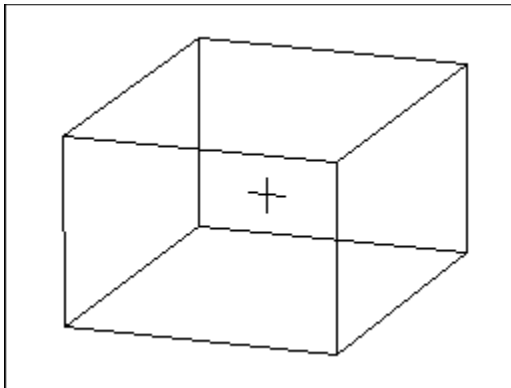

Menu: EDIT  
Submenu: TRIM/EXTEND  
Menu Command: CHAMFER  
Shortcut Key: **Ctrl+F**



Toolbox Icon:

Point 1: One of the lines on the corner to be chamfered  
Point 2: The other side of the corner

The Chamfer command cuts a segment off a corner and replaces the corner with a flat face of specified depth. This command works on line or plane entities in two dimensions. To cut off the corner of a solid object, use the Slice command.

### Using the Command

Choose the CHAMFER command. In the CHAMFER DEPTH box in the Command Line, enter the depth—the distance from the corner to the chamfer edge. The depth you enter will be the value for your next chamfer.



To draw the chamfer but leave the lines that formed the corner also, check the LEAVE ORIGINAL LINE box.

Next, set a point on one of the lines that forms the corner, and set another point on the other line. The corner is cut off to the specified depth.

### Example: Cut one corner off a plane.

Choose the CHAMFER command and set the CHAMFER DEPTH at **3** in the Command Line. Set a point on one of the sides of the plane. Next, set a second point on an adjoining side. The corner of the plane is cut off to the specified depth.

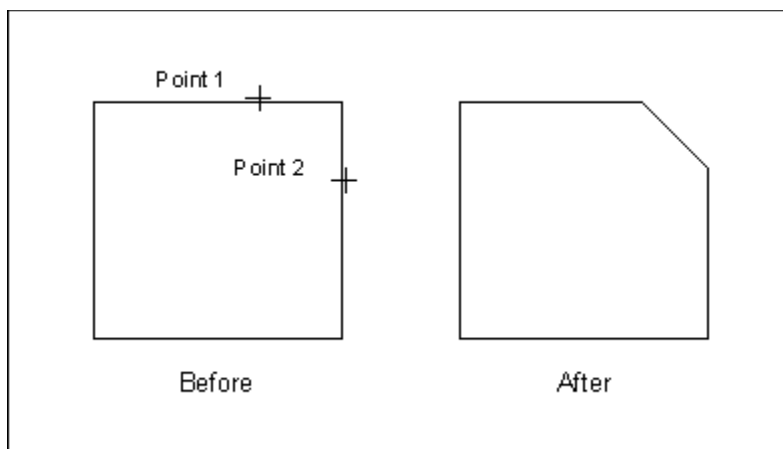

Menu: DRAW  
Submenu: CIRCLE/ELLIPSE  
Menu Command: CIRCLE (3-POINT)



Toolbox Icon:

Point 1: Any point on the circle  
Point 2: A second point on the circle  
Point 3: A third point on the circle

The Circle (3-Point) command draws a circle that passes through three points. The three points must not lie in a straight line.

### Using the Command

The circle is saved in the drawing as one of three forms:

- 1. Circle:** Stored as an actual circle in the drawing.
- 2. Plane:** Stored as a circular plane with 36 sides which can be shaded.
- 3. Line:** Stored as a line entity.



When the CIRCLE option is selected, the circle is saved in the drawing as a Circle entity. This is the way circles are normally saved with DesignCAD 97.

The circle can be saved as a plane so it can be shaded, subtracted, etc.

The circle can also be saved as a line. This makes it possible to scale the circle or treat it as a line entity with other commands.

Usually, you will want to save the circle as a Circle entity or as a Plane entity.

### Example: Draw a circle passing through three points.

Select the CIRCLE (3-POINT) command and set a point on the screen through which the circle will pass. Move the cursor away from the first point in any direction and set a second point. Now, as you move the cursor, you see a rubber-band circle, showing you how the circle would look if you set the final point at the cursor location. Move the cursor along the Z axis by holding down **Ctrl+Shift** and moving the mouse forward or backward. This will move the cursor out or in along the Z axis respectively. The circle will pivot and change size according to the location of the third point on the Z axis. When the circle lies in the desired plane and is the correct size, set the third point.

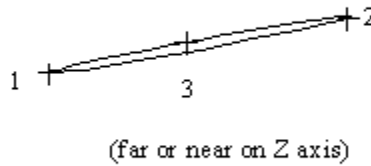
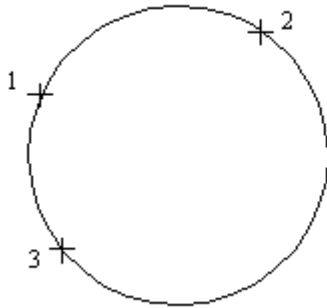

Menu: DRAW  
 Submenu: CIRCLE/ELLIPSE  
 Menu Command: CIRCLE (CENTER, OUTSIDE)  
 Shortcut Key: **O** (the letter, not the number)

Toolbox Icon:



Point 1: Center of the circle  
 Point 2: Point on the circle  
 Point 3: Orientation of the circle (optional)

The Circle (center, outside) command draws a circle based on a point at the center and a point on the outside of the circle. A third point can be used to specify the plane on which the circle lies.

### Using the Command

Select the CIRCLE (CENTER, OUTSIDE) command. The program needs to know the form you want to save the circle in. The Command Line displays your three choices:

1. **Circle:** Stored as an actual circle in the drawing.
2. **Plane:** Stored as a circular plane with 36 sides; plane circles can be shaded.
3. **Line:** Stored as a line entity.



To choose an option click the button beside it. Normally, you'll want to save the circle in the CIRCLE form. If you want to use the circle as you would a solid, select PLANE. Saving the circle as a Line makes it possible to scale the circle or treat it as a line entity.

### Example: Draw a circle using a specific point for the center.

Select the CIRCLE (CENTER, OUTSIDE) command and set a point near the center of the screen.



Move the cursor away from the first point in any direction. Notice that a rubber-band representation of the circle is drawn using the cursor location as a point on the circle. Set a point when the circle is of the desired radius. Now, hold down **Ctrl+Shift** while moving the mouse forward or backward. This moves the cursor away from or toward you on the Z axis respectively. As you do this, the circle will pivot on the hinge set by the first two points. When the circle lies in the plane that you want it to, set the third point.

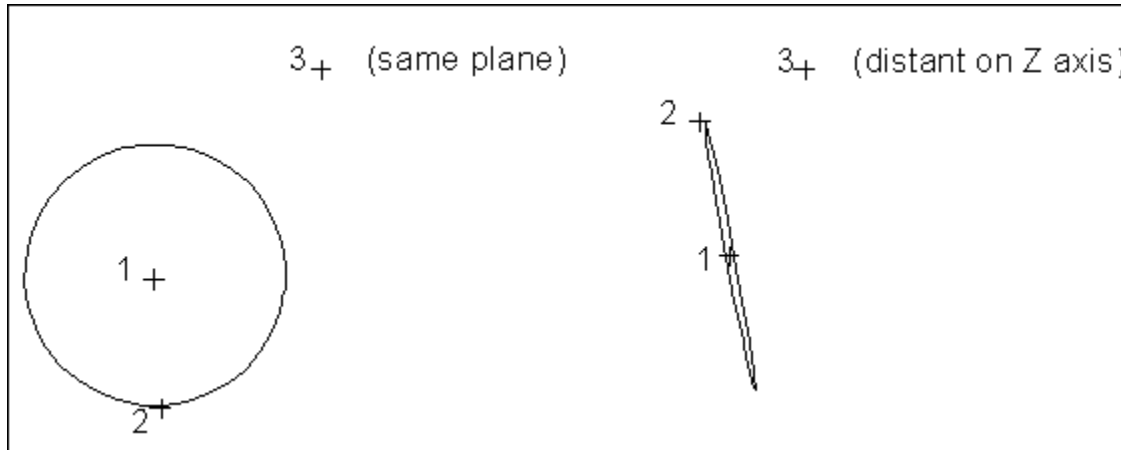

Menu: DRAW  
Submenu: CIRCLE/ELLIPSE  
Menu Command: CIRCLE (CENTER-RADIUS)



Toolbox Icon:  
Point 1: Center of the circle  
Point 2: Orientation of the circle (optional)  
Point 3: Orientation of the circle (optional)

The Circle (Center-Radius) command draws a circle of a specified radius with a point set for the center. Two more points can be used to orient the circle in 3-D space.

### Using the Command

Choose the CIRCLE (CENTER-RADIUS) command in the Main Toolbox. Enter the length of the radius in the RADIUS box. A rubber-band circle shows how the circle will be drawn. Set a point for the center of the circle. Press **Enter** or set a second point to orient the circle. Press **Enter** or set a third point to tilt the circle using the first two points as a hinge. A circle is drawn with the specified radius and with its center at the first point.

The circle can be saved in the drawing as one of three forms:

- 1. Circle:** Stored as an actual circle in the drawing.
- 2. Plane:** Stored as a circular plane with 36 sides which can be shaded.
- 3. Line:** Stored as a line entity.

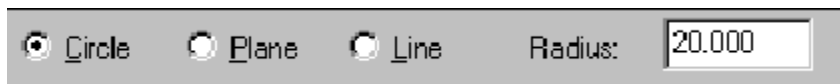

When the CIRCLE option is selected, the circle is saved in the drawing as a Circle entity. This is the way circles are normally saved with DesignCAD 97.

The circle can be saved as a plane so it can be shaded, subtracted, etc.

The circle can also be saved as a line. This makes it possible to scale the circle or treat it as a line entity with other commands.

Usually, you will want to save the circle as a Circle entity or as a Plane entity.

#### Radius

- Enter the length of the radius of the circle in this box.

#### Same As

- To have the radius length the same as another circle in the drawing, click the SAME AS button. Then set a point on the other circle in the drawing.

### Example: Draw a circle with a radius of four.

Choose the CIRCLE (CENTER-RADIUS) command from the Main Toolbox. Enter **4** in the RADIUS box

in the Command Line. When you return to the drawing, a rubber-band circle appears, showing how the circle will be drawn. Now set the point for the center of the circle. Press **Enter**. The circle is drawn with its center at the point and its radius four Drawing Units away.

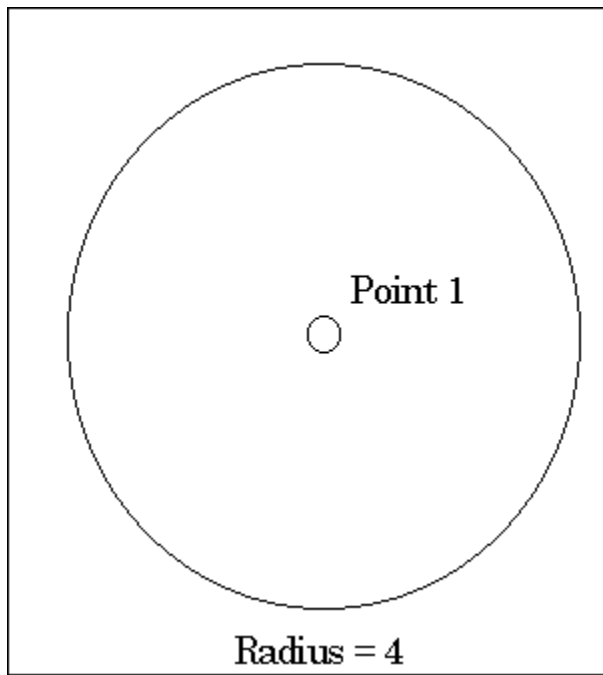

Menu: DRAW  
Submenu: CIRCLE/ELLIPSE  
Menu Command: CIRCLE (DIAMETER)



Toolbox Icon:

Point 1: A point on the diameter of the circle  
Point 2: A point for the opposite diameter of the circle  
Point 3: A point to align the circle in 3-D space (optional)

The Circle (Diameter) command draws a circle between two points, so that the two points lie on the diameter of the circle.

### Using the Command

Set two points for the circle diameter. If necessary, you can set a third point to define the plane on which the circle lies. If you just want to set two points, press **Enter** after you have set them.

The circle is saved in the drawing as one of three forms:

- 1. Circle:** Stored as an actual circle in the drawing.
- 2. Plane:** Stored as a circular plane with 36 sides which can be shaded.
- 3. Line:** Stored as a line entity.



When the CIRCLE option is selected, the circle is saved in the drawing as a Circle entity. This is the way circles are normally saved with DesignCAD 97.

The circle can be saved as a plane so it can be shaded, subtracted, etc.

The circle can also be saved as a line. This makes it possible to scale the circle or treat it as a line entity with other commands.

Usually, you will want to save the circle as a Circle entity or as a Plane entity.

### Example: Draw a circle using two points to define the diameter.

Select the CIRCLE (DIAMETER) command and set a point on the screen for a diameter point on the circle. As you move the cursor, a rubber-band circle is drawn to represent the circle, using the cursor position as the other diameter point. Set the second point when the circle is of the desired diameter. So far, the circle is in the XY plane. Hold down **Ctrl+Shift** while moving the mouse forward or backward and notice how the circle swings on a hinge set by the first two points. When the circle lies in the plane you want it to, set the third point.

3 + (same plane)

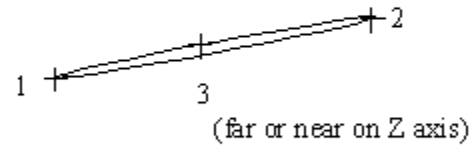
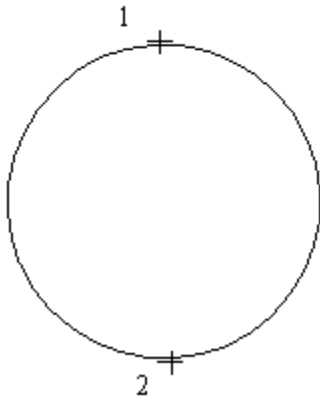

Menu: DRAW  
Submenu: CIRCLE/ELLIPSE  
Menu Command: CIRCLE TANGENT TO TWO LINES



Toolbox Icon:

Point 1: First line tangent to circle  
Point 2: Second line tangent to circle

The Circle Tangent to Two Lines command draws a circle of a specified radius which is tangent to two lines. The two lines must lie in the same plane unless you are currently in 2-D Mode.

### Using the Command

With two lines drawn, select the CIRCLE TANGENT TO TWO LINES command. Enter the radius of the circle in the RADIUS box in the Command Line. Set a point on each of the two lines which are to be tangent to the circle. A circle with the specified radius is drawn tangent to the two lines.

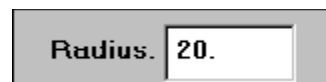

**Note:** If the two lines do not lie in the same plane, and the circle is drawn tangent to the two lines while in 2-D Mode, the circle is drawn at the Z coordinate the cursor was on before the switch to 2-D Mode. This will be apparent when you switch back to 3-D Mode.

---

### Example: Draw a circle with a radius of 10 tangent to two lines that lie on the same plane.

Select the CIRCLE TANGENT TO TWO LINES command and enter a radius of **10** in the RADIUS box in the Command Line. Set a point on one of the lines. When you move the cursor to the other line, a rubber-band circle will be drawn tangent to the two lines. Set the second point to insert the circle into your drawing.

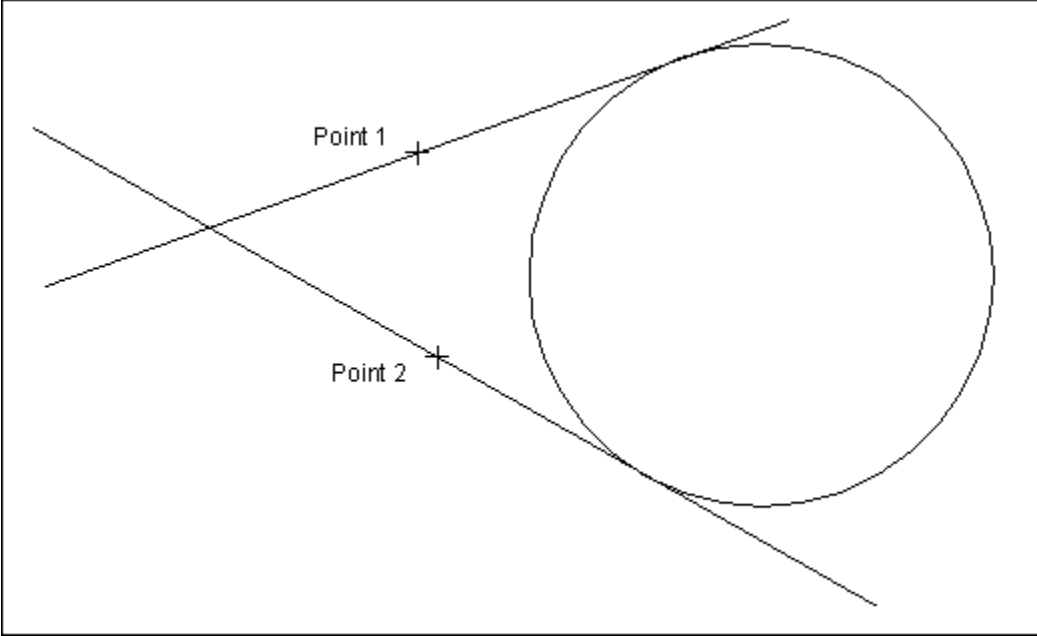

Menu: DRAW  
Submenu: CIRCLE/ELLIPSE  
Menu Command: CIRCLE TANGENT TO THREE LINES



Toolbox Icon:

Point 1: First line tangent to circle  
Point 2: Second line tangent to circle  
Point 3: Third line tangent to circle

The Circle Tangent to Three Lines command draws a circle which is tangent to three lines. The three lines must lie in the same plane unless you are currently in 2-D Mode.

### Using the Command

With three lines drawn, select the CIRCLE TANGENT TO THREE LINES command. Set a point on the first line. Set a point on the second line. After the second point is set, a rubber-band circle shows how the circle will be drawn. Set a point on the third line. A circle is drawn tangent to the three lines.

**Note:** If the three lines do not lie in the same plane, and the circle is drawn tangent to the three lines while in 2-D Mode, the circle is drawn at the Z coordinate the cursor was on before the switch to 2-D Mode. This will be apparent when you switch back to 3-D Mode.

### Example: Draw a circle tangent to three lines that lie on the same plane.

Select the CIRCLE TANGENT TO THREE LINES command. Set a point on one of the lines. Set a point on the second line. When you move the cursor to the third line, a rubber-band circle will be drawn tangent to the three lines. Set the third point to insert the circle into your drawing.

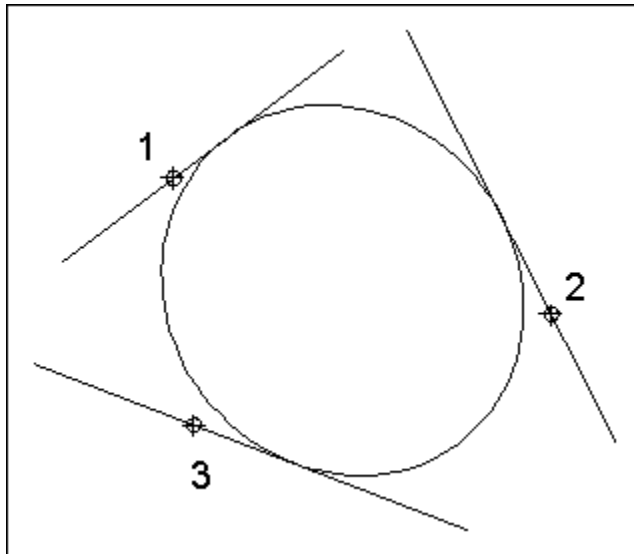



Menu: DRAW  
Menu Command: CIRCULAR ARRAY



Toolbox Icon:

Point 1: Center of rotation  
Point 2: Axis of revolution (Used only with Two-Point Axis mode)

This command copies a selected object a specified number of times in a circular pattern.

### Using the Command

You can set several options in the Command Line.

#### Copies

This is the total number of copies, including the original.

#### Span Angle

This is the angle in which the copies are to be placed. For example, you can use  $360^\circ$  to copy an object in a complete circle, such as the bolts on a wheel. You can use  $180^\circ$  to copy in a semicircle.

#### Offset

This is the distance along the axis of revolution between the first copy and the last copy. The offset can be used to copy objects in a spiral.

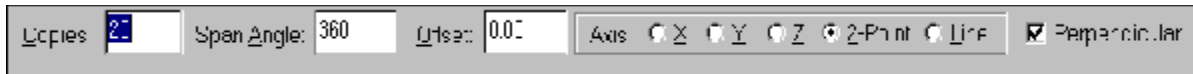

To make a spiral with more than one revolution, use a span angle of more than  $360^\circ$ . For example, to make a spiral with two complete revolutions, you can enter  $720^\circ$  for the span angle. Remember, the number of copies and the offset are the total for the entire operation, not just one revolution.

You can set the rotation along the X, Y, or Z axis, an axis defined by two points, or one defined by an existing line. Only the 2-Point option requires you to set a second point. With the line option you set a point on an existing line and the command uses that line as the axis of rotation. The other options will use your first point as the location of the axis.

The Rotate option is used to specify whether or not the copies for the array will rotate according to their angle of rotation in the array. If the option is checked, the copies will rotate with the array. If the option is not checked, the copies will still be copied in a circular pattern, but they will maintain the same orientation as the original.

### Example: Copy an object 10 times in a circular pattern.

Select the object you want to copy. Next, choose the CIRCULAR ARRAY command. Enter the following settings in the appropriate fields in the Command Line:

COPIES: 10

SPAN ANGLE: 360

OFFSET: 0

Select the TWO POINT option. Set a point a few inches below the object for the center of rotation and another, offset from the first, for the axis of revolution. It may help to think of this as swinging a ball on a string: The selection handle is where the string is connected to the ball, the center of rotation (Point 1) is where your hand holds the string, and the axis of revolution (Point 2) is the direction of your arm.

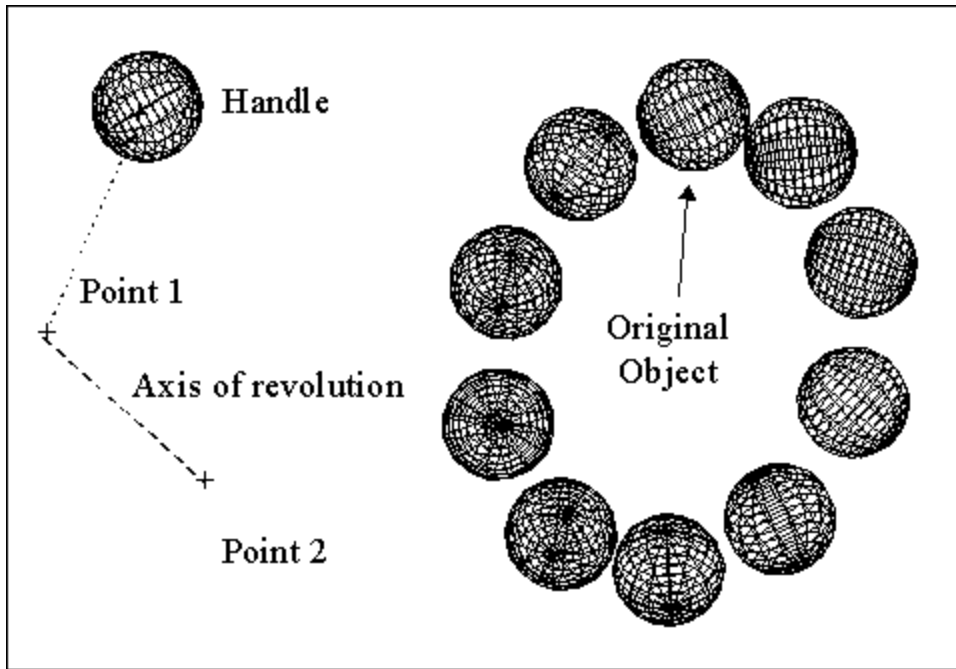

Menu: FILE  
Menu Command: CLOSE

The Close command closes an open drawing.

### Using the Command

Choose the Close command. If the drawing has changed, the program gives you the opportunity of saving the changes:

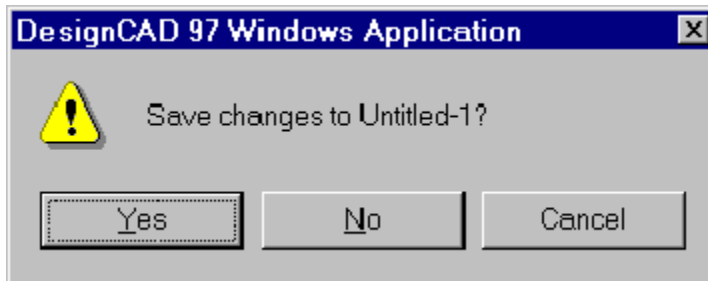

Clicking YES saves the changes. Clicking NO closes the drawing, dropping all modifications since it was last saved. Clicking CANCEL or pressing **Esc** cancels the Close command and returns you to the drawing screen.

Menu: TOOLS  
Submenu: DIGITIZER  
Menu Command: CLOSE DIGITIZER MENU  
Point 1: Point inside the menu area

The Close Digitizer Menu command closes the active digitizer menu.

### **Using the Command**

Choose the CLOSE DIGITIZER MENU command. Set a point inside the menu area. The digitizer menu is closed.

***See Also: Add Menu Item Command, Create Digitizer Menu Command, Digitizer Tracing Mode Command, Load Digitizer Menu Command, Remove Menu Item Command, Save Digitizer Menu Command***

Menu: OPTIONS  
Menu Command: OPTIONS

In the Color Options folder, you can set the color of the background, cursors, grid, points and various selection and rubber-band entities on the drawing screen.

### Using the Command

Choose the OPTIONS command from the OPTIONS menu, and then click the COLOR tab to bring up the Color Options folder.

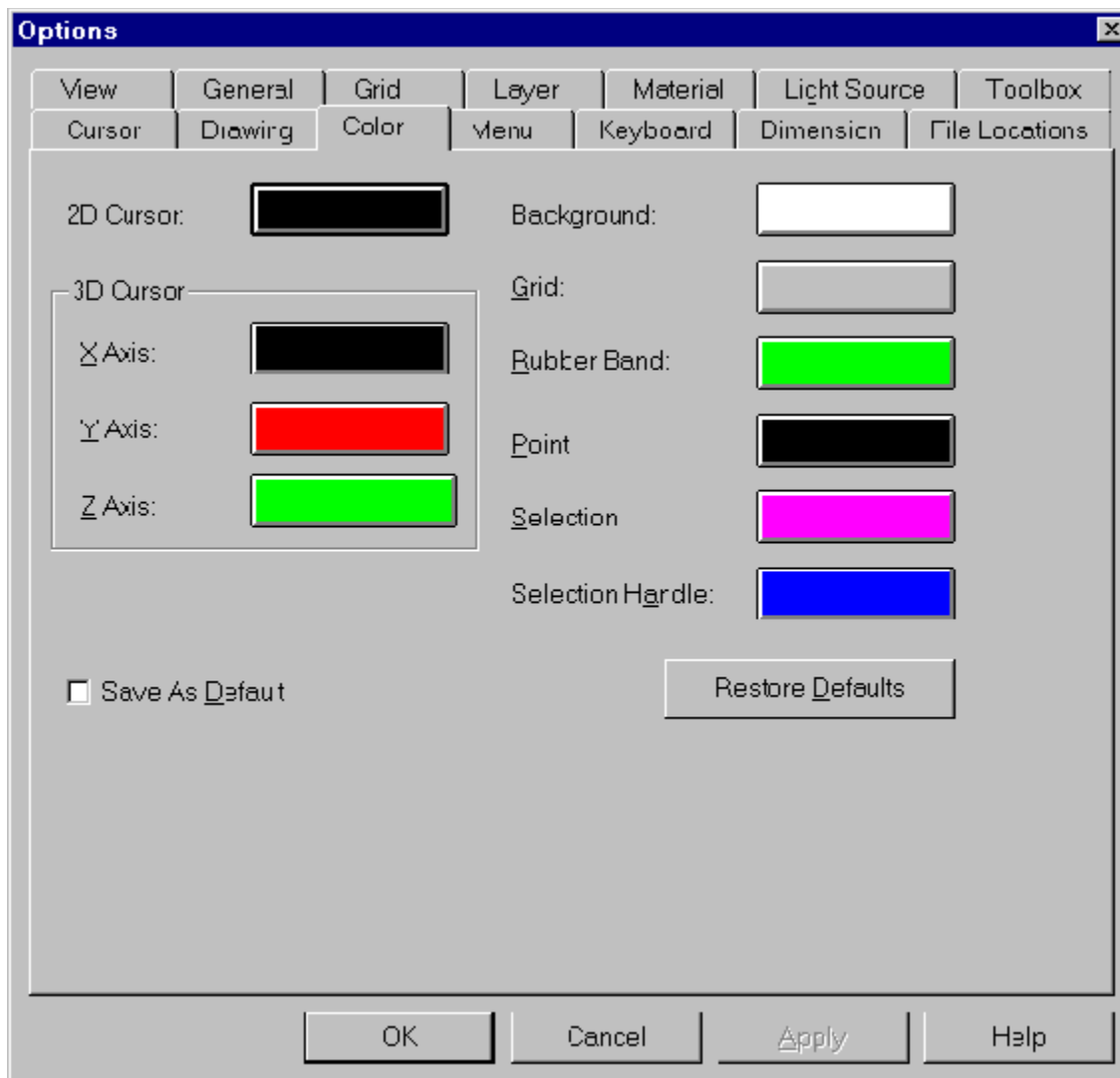

Click the button beside the item you want to change the color for, and the Color Palette box appears.



Click to select the new color for the item. The selected color is highlighted with a black selection border around it. Click OK to set the color.

On the Color Options folder, the large button next to the item you are changing now shows the new color you selected. Click APPLY to make DesignCAD use this color and then OK to close the dialog box.

**Hint:** Before you click the Ok button, Click the Save As Default checkbox if you want DesignCAD to use this color selection the next time you load the program.

---

## **2D Cursor**

This changes the color of the 2D cursor.

## **3D Cursor**

X Axis

This changes the color of the X axis indicator line in the 3D cross hair cursor.

Y Axis

This changes the color of the Y axis indicator line in the 3D cross hair cursor.

Z Axis

This changes the color of the Z axis indicator line in the 3D cross hair cursor.

## **Background**

This changes the color used as the background in the DesignCAD drawing windows.

## **Grid**

This changes the color of the drawing grid. This option is the same as the Display Grid Color option in the Grid folder of the Options file box.

## **Rubber Band**

This changes the color of rubber-band entities.

**Point**

This changes the color of DesignCAD's point indicators used during drawing commands.

**Selection**

This changes the color of a selection box.

**Selection Handle**

This changes the highlight color of a selection handle when a point or drawing entity is selected.

**Restore Defaults**

You can return to DesignCAD's original color settings by clicking the RESTORE DEFAULTS button.

Menu: EDIT  
Submenu: SELECTION  
Menu Command: COMBINE LINES  
Shortcut Key: **B**

The Combine Lines command is used to merge connecting lines and arcs into a single line entity.

### **Using the Command**

Select the entities you wish to combine into a single line. All selected entities **must** share endpoints to form a continuous line. That is, each line entity has to be connected to the next line. This command affects currently selected entities.

This command is similar to the Make Plane command, but the Make Plane command converts the selected lines into a plane instead of a single line entity.

**Note:** Since this command converts circles and arcs into lines, any arcs or circles will lose their center points.

---

### **Example: Convert two lines that meet at their endpoints into a single object.**

Drag a selection box around the objects so that they are selected. Now, select the COMBINE LINES command. The lines are now combined into a single object. This can be seen easily when the new line is selected.



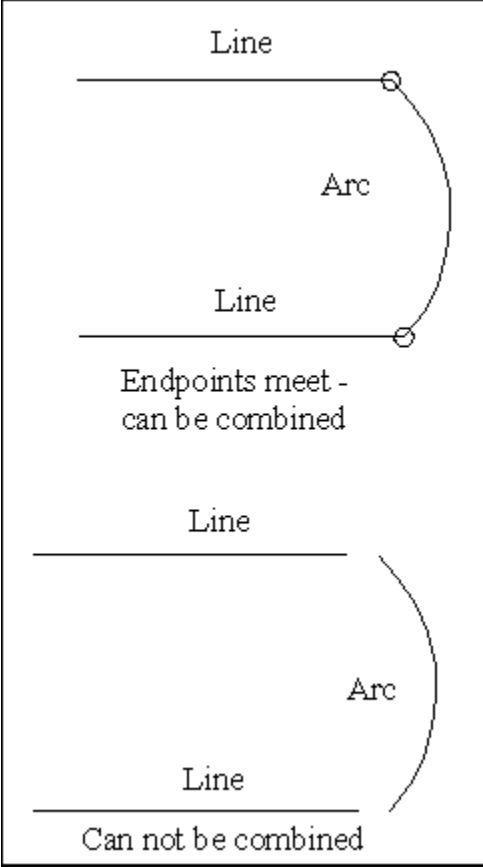

Menu: none  
Shortcut Key: **Spacebar**

Command Line Entry command lets you choose a command by typing the name of the command, or an alias, in the Command Line. With this method you don't have to select commands from the menu or by other means. Also, the program keeps a list of recently entered commands. Once you have entered a command, you can easily choose it again by pressing the Spacebar and using the up or down arrow keys to scroll to the command.

### Using the Command

Press the **Spacebar**. The `COMMAND` box appears. Enter the name of the command or alias in the box and press **Enter**. If any options are associated with the command you have chosen, the Command Line appears as usual. Press the **Tab** key to enter the Command Line and navigate to the option you want. Set the options and then press **Enter** to return to the drawing.

**Note:** Many of the commands let you enter the parameters for the command on the same line in the Command box.

---

### Editing the Command File

The program associates command names and aliases with command IDs in the `DC97CMD.INI` file. When you enter a custom command name, the program still identifies it with the real command name. This gives you a great deal of flexibility in customizing commands. You can even have multiple aliases for the same command.

Commented lines begin with a semicolon. They are not allowed on the same line as an alias. Please use caution when editing the `DC97CMD.INI` file. Make a backup of the file before you try to edit it. Edit only the Add Custom Command section, part of which is shown below. If you edit other sections, you may cause commands to stop working correctly.

```
;=====ADD CUSTOM COMMAND NAME ENTRIES HERE=====
```

```
;
```

```
;These sample commands are laid out following the menu's structure.
```

```
;
```

```
; File Menu
```

```
;
```

```
Nu=ID_DCAD_FILE_NEW
```

```
Ld=ID_DCAD_FILE_OPEN
```

```
QF=ID_DCAD_FILE_CLOSE
```

Sv=ID\_SAVEFILE

SvA=ID\_SAVEFILE\_AS

SvS=ID\_SELECT\_SAVE

### **Creating an Alias**

First, create a blank line for the new alias. Then enter the alias you want to use followed by the equals sign (without spaces) and the actual name of the DesignCAD command. It is not necessary to comment out the existing alias.

Suppose you want to add Clo as an alias for the File Close command. Go to the end of the following line:

QF=ID\_DCAD\_FILE\_CLOSE

Press **Enter** to start a new line. Now enter the new alias as shown below:

clo=ID\_DCAD\_FILE\_CLOSE

You may, of course, copy the DesignCAD command name and paste it in instead of typing it yourself. Save the file when you are sure the information is correct. The next time you start DesignCAD 97 for Windows 95, it reads the file you have edited. Then you can press the Spacebar and enter **clo** in the COMMAND box to close a file.

### **Example: Draw a line from the origin (0,0) to (10,10).**

Press the **Spacebar** to activate the Command Line. Start the LINE command by entering **Line**. Then press the **Enter** key. Next, press the **Spacebar** again. In the COMMAND box enter **pxyz 0,0,0** and press **Enter** to set the first point. Press the **Spacebar** a third time. The previous entry (pxyz 0,0,0) remains in the COMMAND box. Now change the 0,0,0 to **10,10,0** and press **Enter**. That sets the second point. Press **Enter** again to end the Line command. The line is drawn between those two points.

Menu: SOLIDS

Menu Command: CONE



Toolbox Icon:

Point 1: Center of the base of the cone

Point 2: Edge of the base of the cone

Point 3: Height and direction of the cone

The Cone command draws a cone.

### Using the Command

Set a point for the center of the base of the cone, a second point at the edge of the base, and a third point for the cone height.

You can specify the number of sides or facets around the cone in the NO. OF FACETS field in the Command Line.

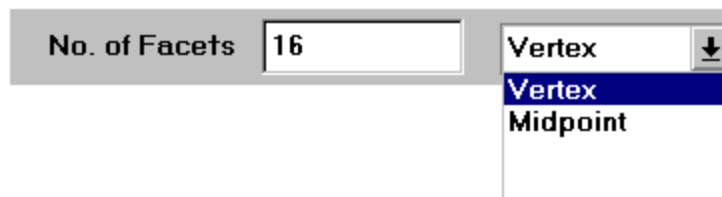

You can also choose whether the midpoint or vertex of the facets will be located at the radius defined by Point 2. If you choose VERTEX, the base of the cone is inscribed by a circle of that radius. If you choose MIDPOINT, the base of the cone circumscribes a circle of that radius. This is normally not significant, but it can be important for some precision drawings.

### Example: Draw a cone.

Select the CONE command. Next set a point for the center of the base. Move the cursor out along the Y axis and set the second point for the radius of the cone. Now move the cursor up until the cone is the desired height and set the third point. The cone is inserted into the drawing.

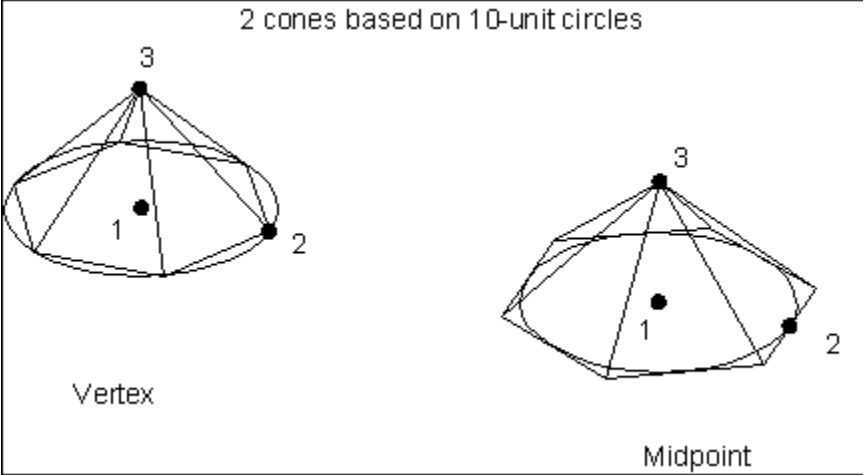

**See Also:** *Truncated Cone Command*

Menu: EDIT  
Menu Command: COPY  
Shortcut Key: **Ctrl+C**

Toolbox Icon:



The Copy command copies selected objects from the DesignCAD 97 drawing screen to the Windows clipboard, *leaving the original objects still in the drawing*. From the clipboard, they can be pasted back into DesignCAD 97 or into other Windows applications.

### **Using the Command**

Select the object or objects to be copied. Choose the COPY command. The program copies the selected items to the clipboard.

#### **Example: Copy an object from your drawing to the Windows clipboard.**

Select the object and click the COPY icon. Then select PASTE from the EDIT menu. Drag the green box to the location where you want to put the copy and click the left mouse button. The object is inserted into the drawing.

If you want to paste the object into another drawing or Windows application, you can do so without recopying. The object remains in the Clipboard until another object is cut or copied to the Clipboard, replacing it.

**See Also: Cut Command, Paste Command**

Menu: EDIT  
Menu Command: COPY IMAGE  
Point 1: First corner of rubber-band box  
Point 2: Opposite corner of the box

The Copy Image command copies text or graphics onto the Clipboard. Copying text or graphics to the Clipboard replaces the contents previously stored there.

The Copy Image command is similar to the Copy command except the entities are not selected prior to selecting the command. The Copy Image command copies only what is enclosed in the rubber-band box. The image is treated like a Metafile because the OLE object information is bypassed.

### **Using the Command**

Choose the COPY IMAGE command from the EDIT menu. Set a point for the first corner of a rubber-band box that will be used to define the image to be copied to the Clipboard. Use the mouse to enclose the image with the rubber-band box. When the rubber-band box surrounds the image you want copied, set another point for the opposite corner of the rubber-band box. A copy of the image is placed onto the Clipboard.

Hint: You can also use the Copy Image command to copy part of several entities onto the Clipboard. The image is treated like a drawing instead of a CAD object.

---

***See Also: Copy Command, Cut Command, Paste Command***

Menu: TOOLS  
Submenu: DIGITIZER  
Menu Command: CREATE DIGITIZER MENU

The Create Digitizer Menu command creates a digitizer menu. The menu created with this command does not appear on the screen. The menu contains several selection boxes. These boxes are spaces where commands are selected.

### Using the Command

To create a digitizer menu, follow these steps:

1. Draw the menu template. This is the paper template that will be affixed to the digitizer. To start with, draw a border box the size of the menu. The menu can be any size, but the larger the menu template is, the more of the digitizer drawing area the menu will take up.
2. On the template, draw individual "command" boxes for each DesignCAD command you want on the menu. These command boxes can be any size you want. Draw text or a picture to be associated with each command in the command box.
3. Print the finished template at a scale of 1. Cut it out and affix it to the digitizer, inside the active drawing area of the digitizer.
4. Choose CREATE DIGITIZER MENU from the DIGITIZER submenu in the TOOLS menu. Choose the method of creation in the Digitizer Menu dialog box. Then click the OK button.
5. Now set a point in the lower-left corner of the digitizer template. Set a point in the upper-right corner of the digitizer template.
6. Next, set a point in the lower-left corner of the command box. Set a point in the upper-right corner of the command box.
7. Enter the command name in the COMMAND box. The DesignCAD macro command names can be found in the "BasicCAD for DesignCAD 97" section.
8. Set two more points for the next command box, or press the **Enter** button to end the command.



Menu: OPTIONS  
Menu Command: CROSSHAIR

The Crosshair command indicates the cursor's position with cross hairs in all views.

### Using the Command

Using the Crosshair command helps you easily distinguish the cursor's position, in relation to objects, from several angles. This makes it easy to see the cursor's location in all three dimensions. When you choose the command, the cross hairs become visible on the drawing screen. To remove the cross hairs, choose the CROSSHAIR command.

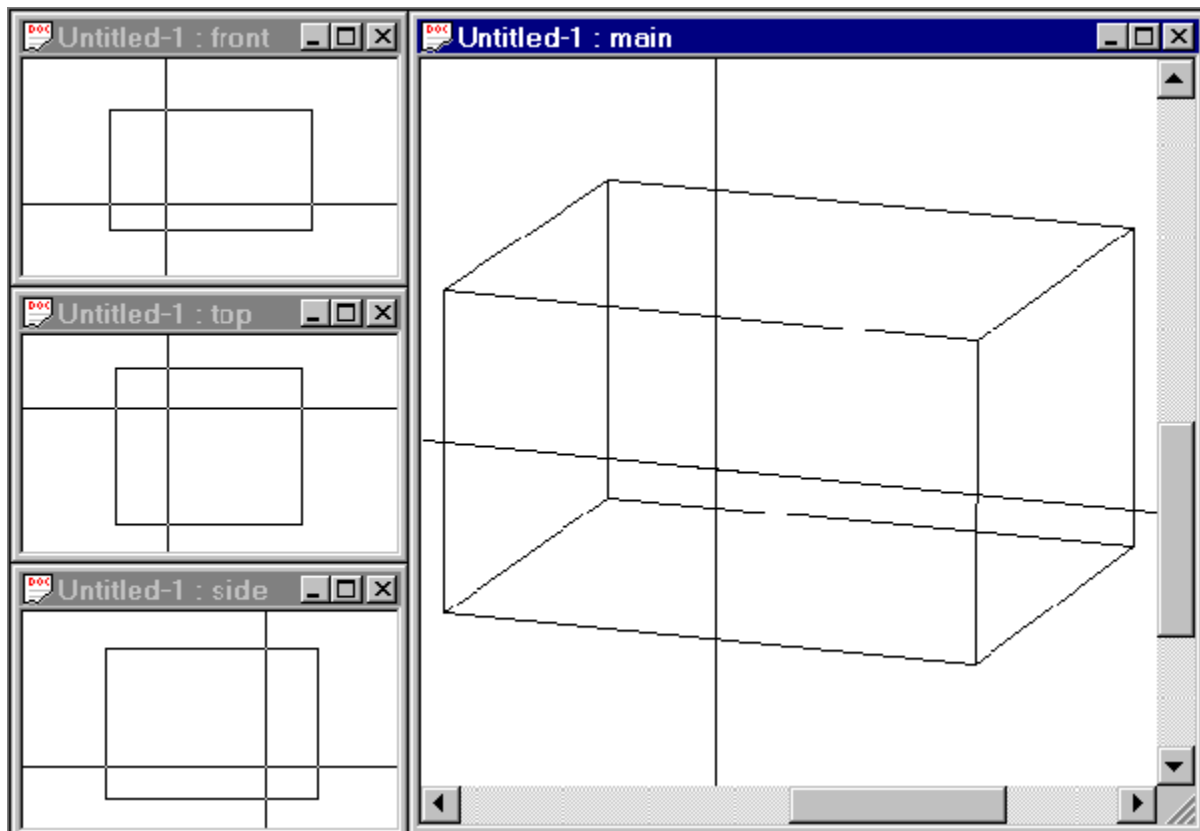

Menu: OPTIONS  
Menu Command: OPTIONS

In the Cursor Options folder, you can set the size of the cursor and the small and large step sizes for it.

### Using the Command

Choose the OPTIONS command, and then click the CURSOR tab to bring up the Cursor Options folder.

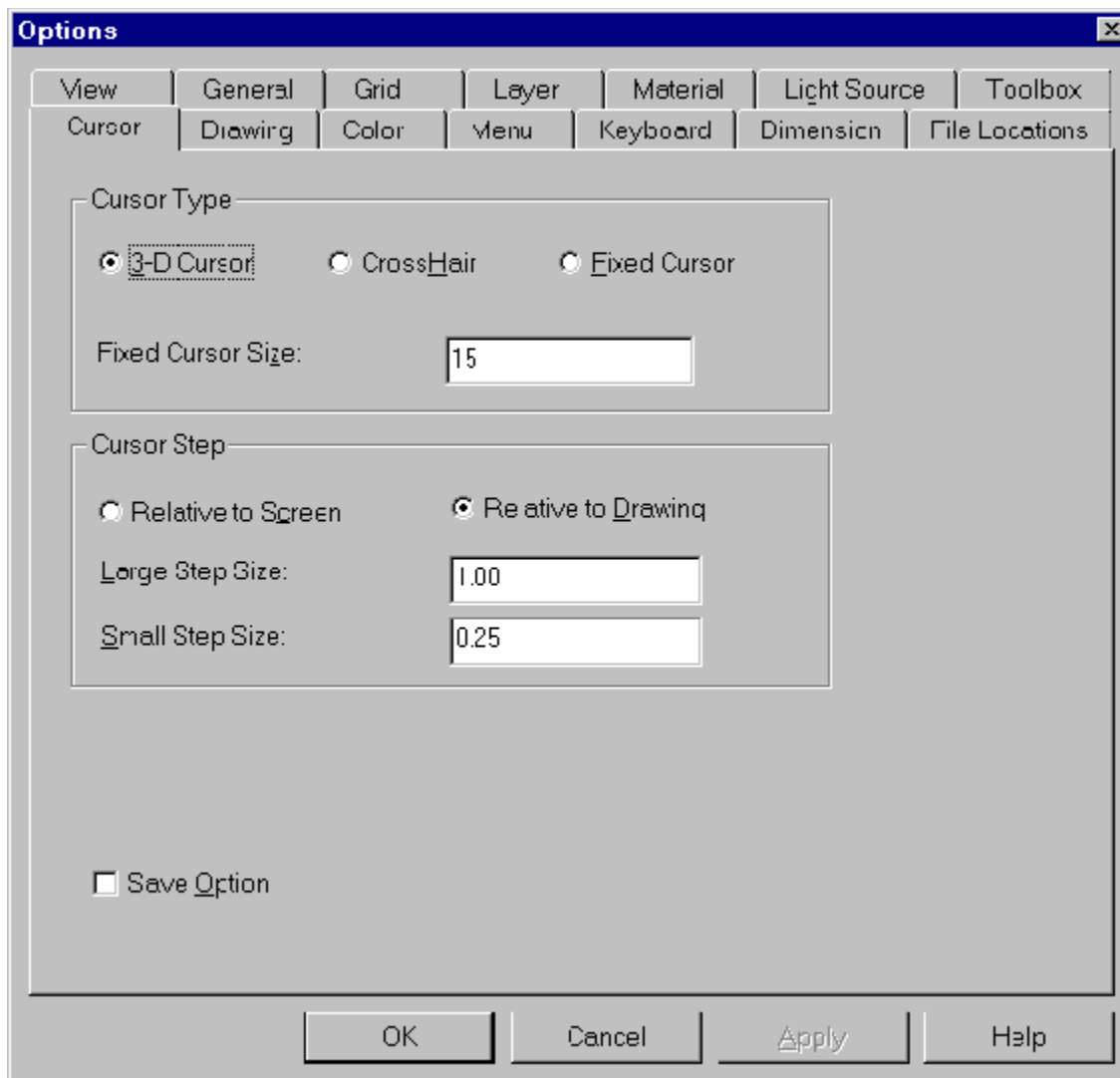

### Cursor Type

#### 3-D Cursor

- This causes the cursor to appear closer or further away according to its location on the Z axis.

#### Cross Hair

- Choosing this option turns the cursor into a pair of cross hairs that extend to the ends of the screen.

#### Fixed Cursor

- Choosing this option causes the cursor to remain one size during the drawing session.

#### Fixed Cursor Size

- Choosing this option sets the size of the cursor in Drawing Units.

### Cursor Step

#### Relative to Screen

- With this option selected, the cursor will always move the same number of pixels across the screen, regardless of the zoom factor.

#### Relative to Drawing

- This option makes the cursor always move the same number of Drawing Units, regardless of the zoom factor.

#### Large Step Size

- Choosing this option sets the number of Drawing Units that the cursor moves when you press the **Arrow** keys or **Ctrl+Home** or **Ctrl+End**.

#### Small Step Size

- Choosing this option sets the number of Drawing Units the cursor moves when you press **Shift** while using the **Arrow** keys or **Ctrl+Home** or **Ctrl+End**.

Menu: OPTIONS  
Menu Command: CURSOR  
Shortcut Key: I

The Cursor command changes the distance the cursor moves when you use the cursor movement keys on the keyboard.

### **Using the Command**

Choose the CURSOR command. The Cursor Options folder appears. Set the options to meet your drawing needs. (See "Cursor Options" for details.)

### **Example: Set the large cursor step at one foot and the small cursor step at one inch.**

For this example, we must assume that one drawing unit represents one foot. First, choose the CURSOR command. Then click the button for RELATIVE TO DRAWING. Enter **1** for the LARGE STEP SIZE and **1/12** or **1"** for the SMALL STEP SIZE.

Menu: DRAW  
Submenu: LINES  
Menu Command: CURVE  
Shortcut Key: **C**



Toolbox Icon:

Point 1-n: Points for the curve to pass through

The Curve command draws a cubic spline curve through up to 200 points. The points for a curve do not have to lie in the same plane.

The curve can be saved as a line by clicking on the SAVE IN VECTOR FORM option in the Command Line.

**Example: Draw a curve.**

Select the CURVE command. Set three points on the screen. A curve is drawn through the three points.

**Hint:** To make a “corner” in the curve, set two consecutive points in the same location. This will cause two separate curves to be drawn, one on each side of the corner.

---

Menu: EDIT  
Submenu: SELECTION  
Menu Command: CURVE TO LINE

The Curve to Line command changes a curve entity into a line using the same points as those that defined the curve.

### Using the Command

Select the curve that you wish to convert to a line. Choose the CURVE TO LINE command. The selected curve is changed to a line.

### Example: Change a closed curve into a closed line.

Select the curve to be changed. Choose the CURVE TO LINE command. The curve becomes a line with the same number of points.

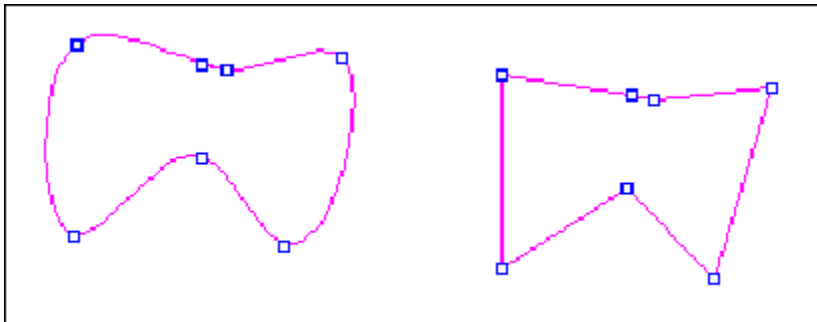

**See Also:** *Line to Curve*

Menu: OPTIONS  
Menu Command: CUSTOM COLOR

The Custom Color command is used to edit the currently selected drawing color.

### Using the Command

Choose CUSTOM COLOR command. In the Edit Color box, move the sliders to adjust the levels of red, green, and blue in the new drawing color, or enter the RGB values.

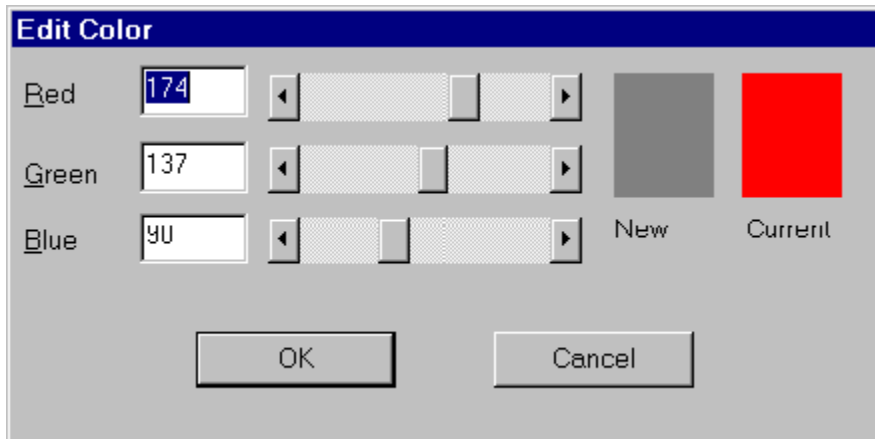

When the color is the one you want, click OK or press **Enter**. That color appears in the Main Toolbox as the current color, and new objects will be drawn in that color.

### Example: Change the color used to draw entities.

Select the CUSTOM COLOR command. Move the sliders and notice how the color in the NEW box changes. When you have set the RGB values, click OK.

Menu: EDIT  
Menu Command: CUT  
Shortcut Key: **Ctrl+X**

Toolbox Icon:



The Cut command removes a selected object or group of objects from the drawing screen and places them on the Windows clipboard. From there you can paste the contents back into DesignCAD 97, DesignCAD 3D, DesignCAD 2D for Windows 95, and many other Windows applications.

### **Using the Command**

Select the object or objects you want to remove from the drawing and place in the clipboard. Then choose the CUT command. The selection is cut to the clipboard.

### **Example: Remove an object from your drawing and place it on the Windows clipboard.**

Select the object and click the CUT icon. The object is removed from the drawing. Then select PASTE from the EDIT menu. Drag the green box to the location where you want to replace the object and click the left mouse button. The object is then inserted into the drawing.

***See Also: Copy Command, Paste Command***



Menu: EDIT  
Menu Command: CUT PLANE  
Point 1: Cutting line  
Point 2: Plane to be cut

The Cut Plane command can be used to slice a plane into two or more pieces along a line.

**Note:** The cutting line, or part of it, is erased during this command, so make a copy if necessary. If you forget, you can Undo the command, copy the line, and re-cut the plane.

### Using the Command

The Cut Plane command requires a plane to cut and a line to cut it with. Choose the CUT PLANE command. Set a point on the cutting line, first, and then a point on the plane to be cut.

### Example: Divide a plane along a line which spans it.

Choose the CUT PLANE command. Set one point on the line and another on the plane. The line disappears, and the plane is now divided into sections.

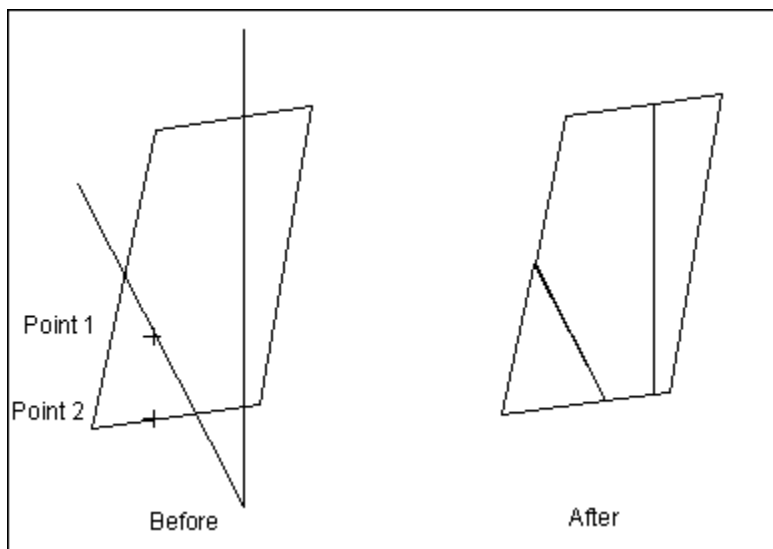

Menu: SOLIDS  
Menu Command: CYLINDER



Toolbox Icon:

Point 1: Center of the cylinder face  
Point 2: Radius of the cylinder  
Point 3: Length and direction of the cylinder

The Cylinder command draws a solid cylinder.

### Using the Command

You can specify the number of sides or facets around the cylinder in the NO. OF FACETS box in the Command Line.

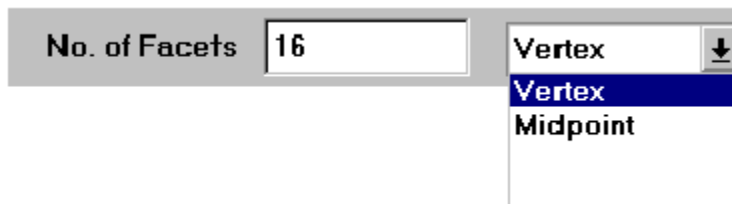

You can also choose whether the midpoint or vertex of the facets will be located at the radius defined by Point 2. If you choose VERTEX, the base of the cylinder is inscribed by a circle of that radius. If you choose MIDPOINT, the base of the cylinder circumscribes a circle of that radius. This is normally not significant, but it can be important for some precision drawings.

### Example: Draw a cylinder in your drawing.

Select the CYLINDER command. Set a point for the center of the base. Move the cursor out along the Y axis and set the second point for the radius of the cylinder. Next, move the cursor up until the cylinder is of the desired height, and set the third point. The cylinder will be inserted into the drawing.

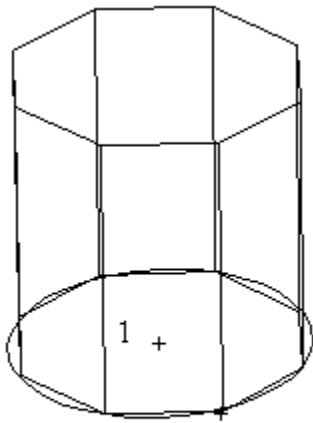

2

Vertex

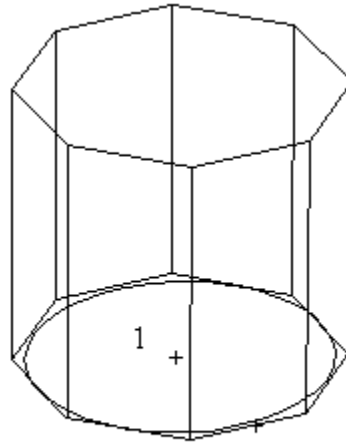

2

Midpoint

Menu: WINDOW  
Menu Command: DESIGNCAD TILE

The DesignCAD Tile command arranges the active drawing windows according to the DesignCAD Tile setting. The default setting places the Perspective view in the large window on the right side of the screen, and the Front, Top, and Side views stacked vertically on the left. This is a convenient window arrangement for working in 3-D space, when using 3-D Selection Mode, and when working in 2-D or 3-D Mode with a large object which contains small items that need to be zoomed for detailed drawing.

### Using the Command

Choose the DESIGNCAD TILE command in the WINDOW menu. The program arranges the windows according to the DesignCAD Tile setting which can be changed with the Set As DesignCAD Tile command. The default setting has Perspective, Front, Top, and Side views.

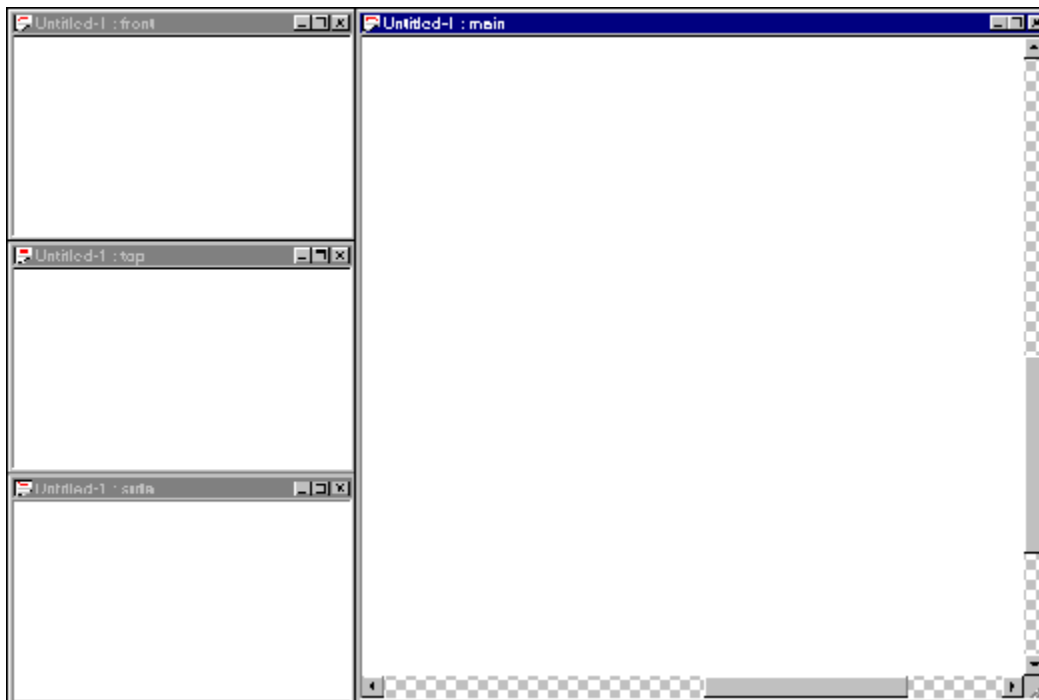

**See Also:** *Restore DesignCAD Tile Command, Set As DesignCAD Tile Command*

Menu: TOOLS  
Submenu: DIGITIZER  
Menu Command: DIGITIZER TRACING MODE

The Digitizer Tracing Mode command lets you zoom the screen image of the drawing you are tracing while retaining the present scale on the digitizer pad.

### **Using the Command**

Make sure there is a check mark next to the DIGITIZER TRACING MODE indicating that it's active. Use the Zoom commands to zoom the current screen image of your drawing. The Zoom commands will not change the relationship between the drawing information being entered and the digitizer pad. Zoom commands only change the size or location of the drawing on the screen.

***See Also: Zoom Command, Zoom In Command, Zoom Out Command***

Menu: DIMENSION  
Menu Command: DIMENSION  
Shortcut Key: @



Toolbox Icon:

Point 1: Start of distance to be measured  
Point 2: End of distance to be measured  
Point 3: Dimension text location

The Dimension command places dimensions in your drawing.

### Using the Command

Choose the DIMENSION command. To add a dimension to your drawing, set two points for the distance to be measured. Then set a third point for the dimension text location.

Several options are available in the Command Line.

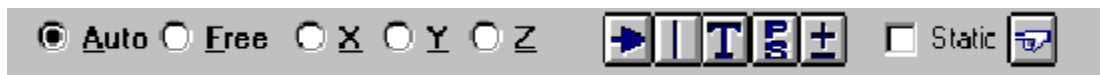

Auto

- Selecting the AUTO option causes the program to determine automatically which axis you wish to measure based on where you place the dimension text.

Free

- Selecting the FREE option lets you measure along any arbitrary direction. The dimension text will always be placed parallel to the distance measured.

X, Y, Z

- Selecting any of these causes DesignCAD to measure only the distance parallel to that axis along the measured path.

Dimension Line





- The dimension line can be positioned inside or outside the extension line.
- Enter the amount of offset in the OFFSET box
- In the TYPE and SIZE boxes specify the arrowhead options you want to use.
- In any dimension option box, click the RESET button to reset the options to their usual settings.
- In any dimension option box, click the SAME AS button to copy dimension settings from a dimension in the drawing.

#### Extension Line

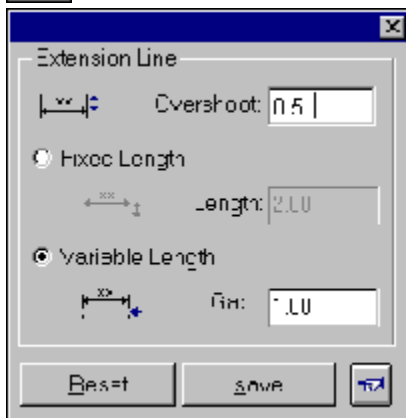

- Specify the amount of the overshoot in the OVERSHOOT box.
- You can choose whether you want FIXED LENGTH or VARIABLE LENGTH.
- Specify the amount of the gap in the GAP box.

#### Dimension Text



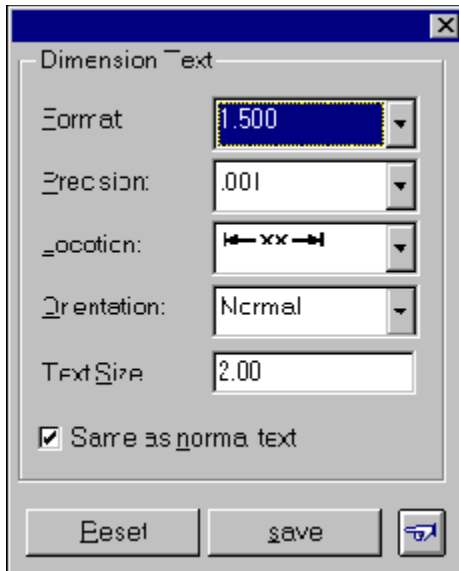

- Any Windows font can be used for dimensions. The dimension text size can be specified in Drawing Units.
- The Format option offers several different numeric formats for the dimensions.
- Specify the number of digits to the right of the decimal point with the PRECISION option.
- The dimension text can be placed inside or outside the extension line, to the right or left of the dimension arrows, or between the terminators.

#### Prefix/Suffix



- The PREFIX option lets you add a notation before the dimension measurement. You can keep a list of up to five custom notations that are available for dimensioning.
  - The SUFFIX option lets you add a notation after the dimension measurement. You can keep a list of up to five custom notations that are available for dimensioning.
- Both boxes work the same. Click on the down arrow, choose the custom number, and enter the notation you want to add to your drawing.

#### Tolerance





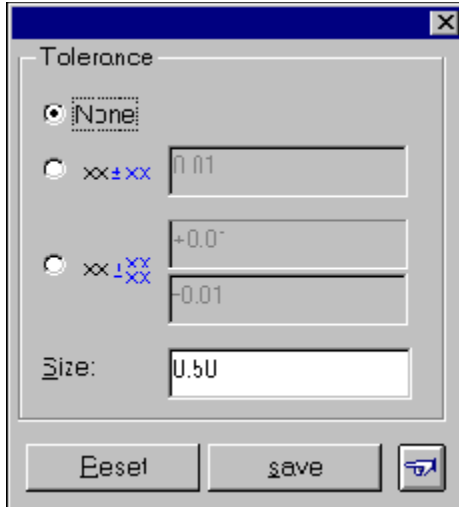

**Static**

- The default setting (Dynamic dimensioning) causes DesignCAD to update the dimension text anytime the dimension changes size (e.g., when resetting Drawing Units, or stretching an object and its associated dimension). Checking the **STATIC** box forces the program to keep the same dimension, regardless of changes.

**Same As**

- Selecting the **SAME AS** box lets you use the same options as another dimension in your drawing. After choosing Same As, set a point on the dimension in the drawing. The new dimension will have the same settings.

**Extension line**

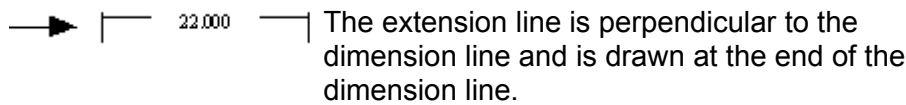

**Overshoot**

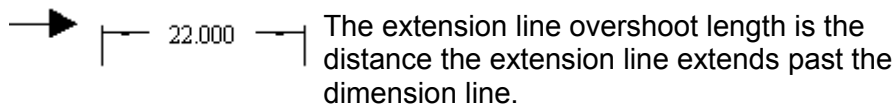

**Gap**

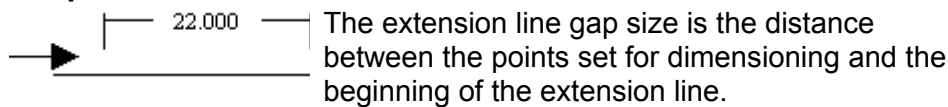

**Terminator or arrowhead**

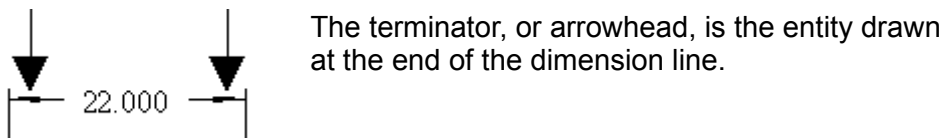

**Arrowhead styles**

You can select the arrow style you want by pulling down the Arrow Type list box in the

Dimension Line dialog box .

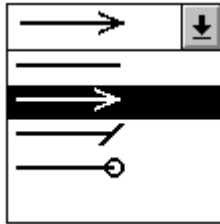

Several arrow styles are available.

**Hint:** The Dimension Options folder gives you control over all options in DesignCAD's 12 dimension commands from a single menu. To use the Dimension Options folder, choose the OPTIONS command from the OPTIONS menu, and then click the Dimension tab. Select the type of dimension command for which you would like to set the options from the Current Dimension Type box.

---

**Example: Measure the distance between two points in your drawing and insert that figure as a dimension notation.**

Choose the DIMENSION command. Set a point on the first point to be dimensioned and another on the second. As you move the cursor away from the points, a rubber-band dimension line and text box appear on the screen. When the dimension is in the desired location, set the final point to insert the dimension in your drawing.

Menu: DIMENSION  
Submenu: DIMENSION ANGLE



Toolbox Icon:

- Point 1: Center of the angle to be measured
- Point 2: Beginning of the angle
- Point 3: Endpoint of the angle
- Point 4: Distance at which the dimension text is to be inserted

The Dimension Angle command lets you add the dimensions of angles to your drawing.

### Using the Command

Choose the Dimension Angle command. Set a point for the center of the angle to be measured. Then set points for the beginning and end of the angle. Finally, set a point to fix how far away the dimension is to be from the angle. The angle is measured and the dimension is added to your drawing.

**Hint:** The options available in the Dimension Angle command are also available in the Dimension command, and are accessed the same way. For details, refer to the "Dimension Command."

---

### Example: Measure the angle of a three-point line.

Select the DIMENSION ANGLE command. Set a point at the corner of your three-point line for the center of the angle. Next, set a point on the "lower" branch of the line. This is important because the DIMENSION ANGLE command measures positive angles. If you start with the top branch and move to the lower, then DesignCAD measures the obtuse angle around the outside of the three-point line.

Set a third point on the "upper" branch of the line and move the cursor away from the line. Notice the rubber-band dimension line and text box drawn on the screen. When the dimension is where you want it, set the final point.

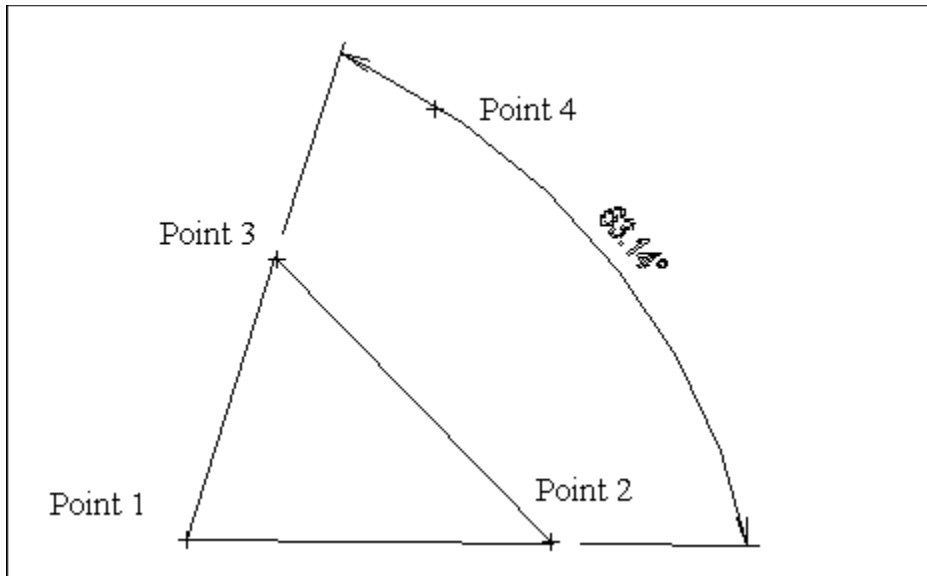

**Hint:** The Dimension Options folder gives you control over all options in DesignCAD's 12 dimension commands from a single menu. To use the Dimension Options folder, choose the OPTIONS command from the OPTIONS menu, and then click the Dimension tab. Select the type of dimension command for which you would like to set the options from the Current Dimension Type box.

**See Also:** *Dimension Command*

Menu: DIMENSION  
Menu Command: DIMENSION ARC



Toolbox Icon:  
Point 1: Arc to be dimensioned  
Point 2: Text location

The Dimension Arc command dimensions the linear length of an arc from endpoint to endpoint.

### Using the Command

Choose the DIMENSION ARC command in the Toolbox. To have the dimension drawn with the same options as another dimension in the drawing, click the SAME AS button. Then set a point on the dimension in the drawing. Set a point on the arc to be measured. After the point is set, a rubber-band line shows how the dimension will be drawn. Set a point for the location of the text information. The linear length of the arc will be calculated and inserted into the drawing at the last point.

**Hint:** The options available in the Dimension Arc command are also available in the Dimension command, and are accessed the same way. For details, refer to the “Dimension Command.”

---

### Example: Draw a dimension of an arc.

First, select DIMENSION ARC from the DIMENSION menu. Then set a point on the arc to be dimensioned. Set a second point for the text location. The dimension of the arc will be calculated and inserted into the drawing.

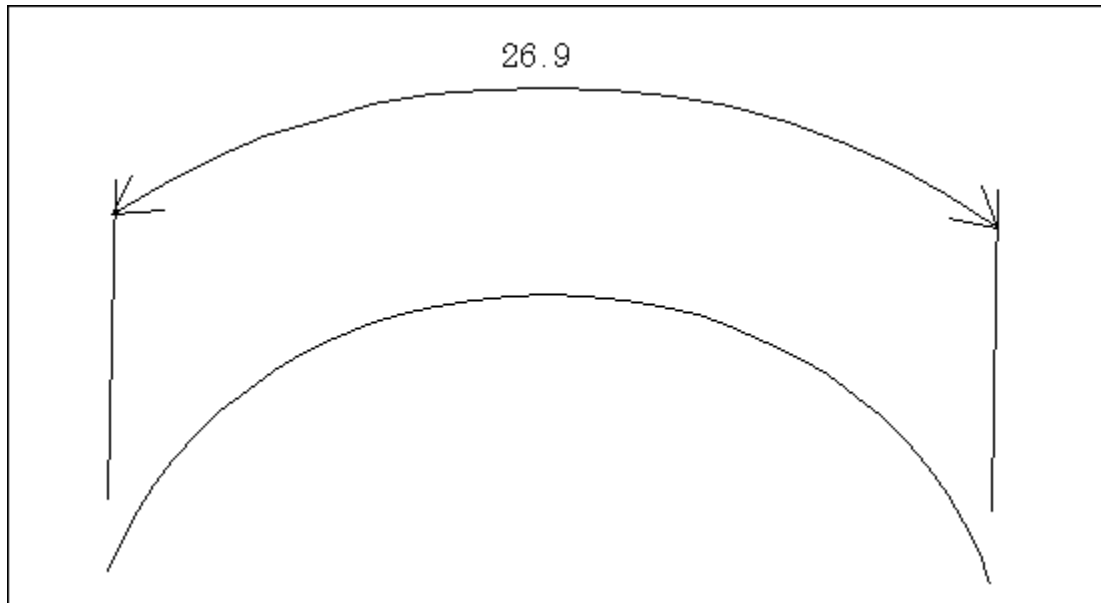

**Hint:** The Dimension Options folder gives you control over all options in DesignCAD's 12 dimension commands from a single menu. To use the Dimension Options folder, choose the OPTIONS command from the OPTIONS menu, and then click the Dimension tab. Select

---

the type of dimension command for which you would like to set the options from the Current Dimension Type box.

---

**See Also:** *Dimension Command, Dimension Angle Command*

Menu: DIMENSION  
Menu Command: DIMENSION BASELINE



Toolbox Icon:

Point 1-n: Points to be measured  
Point n+1: Location for dimension information

The Dimension Baseline command draws dimensions using several points along a baseline. Points are set for each measurement position. The distance measured is the vertical or horizontal distance to the measurement points. Each distance is measured from the first point.

### Using the Command

Choose the DIMENSION BASELINE command from the Toolbox. Click the HORIZONTAL button to draw horizontal dimensions, or click the VERTICAL button to draw vertical dimensions. Next set a point for the base measurement point. Set points for the other measurement points. A rubber-band line shows how the dimension will be drawn. Set a point for the location of the dimension text. Click the middle mouse button or press **Enter**. The dimension is drawn using the points.

**Hint:** The other options available in the Dimension Baseline command are also available in the Dimension command, and are accessed the same way. For details, refer to the "Dimension Command."

---

### Example: Dimension the baseline of a box.

Select the DIMENSION BASELINE command from the Main Toolbox. Choose the HORIZONTAL option in the Command Line. Set a point for the baseline on the left endpoint of the bottom line of the box. Set two more points for the distance of the bottom line of the box. Set a point in the center and below the line for the text. Press **Enter**. The dimension is drawn using the points.

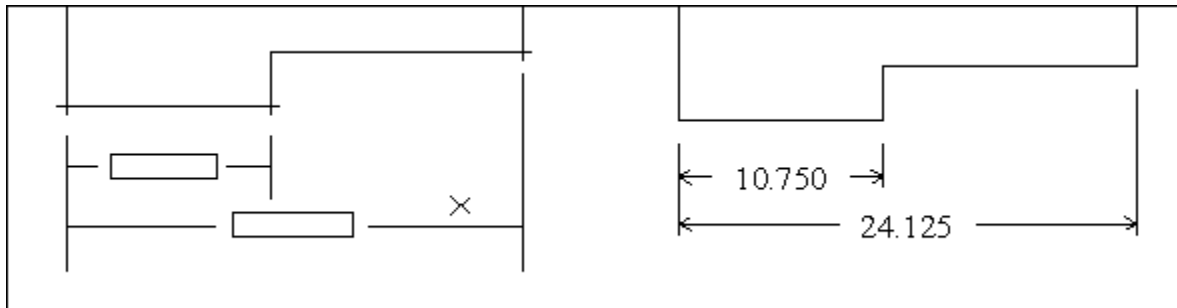

**Hint:** The Dimension Options folder gives you control over all options in DesignCAD's 12 dimension commands from a single menu. To use the Dimension Options folder, choose the OPTIONS command from the OPTIONS menu, and then click the Dimension tab. Select the type of dimension command for which you would like to set the options from the Current Dimension Type box.

---

**See Also:** *Dimension Command*

Menu: DIMENSION  
Menu Command: DIMENSION CHAMFER



Toolbox Icon:

Point 1: Line to be dimensioned  
Point 2-n: Extension line  
Point n+1: Text location

The Dimension Chamfer command draws the dimension for a chamfered line. This calculated distance is the vertical or horizontal distance between the two corners of the chamfer.

### Using the Command

Choose the DIMENSION CHAMFER command in the Main Toolbox. Set a point on the chamfered line. A rubber-band line shows how the dimension will be drawn. Set one or more points for the extension line. Set a point for the text location. Click the middle mouse button or press **Enter** to end the command. The dimension information for the chamfer is drawn at the last point.

**Hint:** The options available in the Dimension Chamfer command are also available in the Dimension command, and are accessed the same way. For details, refer to the “Dimension Command.”

---

### Example: Dimension the chamfer depth of a line.

Chamfer a line with the CHAMFER command. Then select the DIMENSION CHAMFER command from the Main Toolbox. Set a point on the chamfer line. Set a points for a corner in the extension line. Set another point for the location of the text. Press **Enter**. The dimension information is drawn at the last point.

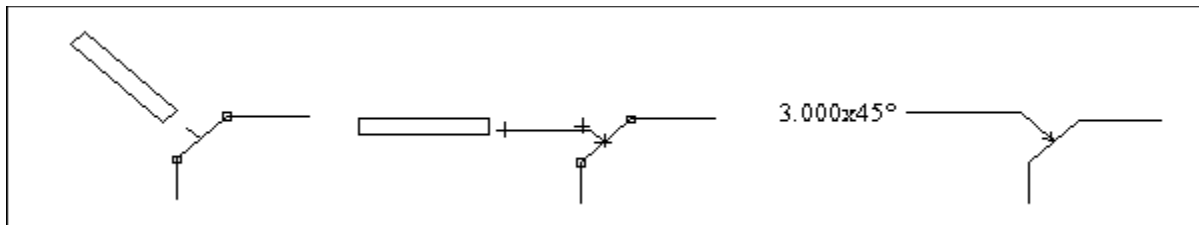

**Hint:** The Dimension Options folder gives you control over all options in DesignCAD's 12 dimension commands from a single menu. To use the Dimension Options folder, choose the OPTIONS command from the OPTIONS menu, and then click the Dimension tab. Select the type of dimension command for which you would like to set the options from the Current Dimension Type box.

---

**See Also:** *Dimension Command*



Menu: DIMENSION  
Menu Command: DIMENSION COORDINATE



Toolbox Icon:  
Point 1: Reference point  
Point 2: Point to be dimensioned  
Point 3: Location for dimension information

The Dimension Coordinate command draws coordinate dimensions relative to a base point. The first point is the origin, or reference point, from which subsequent points are dimensioned. After the base point is set, pairs of points are set. The first point of each pair is the measurement point; the second is the text location.

If the second point in the pair of points is set above or below the first point, the X-value, or horizontal distance, from the reference point will be placed in the drawing. If the second point is set to the right or left of the first point, the Y-value, or vertical distance, from the reference point will be placed into the drawing. Finally, if the second point in a pair of points is set closer or further away along the Z-axis, the relative Z coordinate is placed into the drawing.

### Using the Command

Choose the DIMENSION COORDINATE command in the Main Toolbox. Set a point for the origin, or reference point. Set a point for the point to be measured. Set a point for the text location. Click the mouse or press **Enter** to end the command.

**Hint:** The options available in the Dimension Coordinate command are also available in the Dimension command, and are accessed the same way. For details, refer to the "Dimension Command."

---

The dimension is measured horizontally, vertically, or along the Z axis from the first point to the second point depending on the relative location of the third point to the second. The dimension text is drawn at the last point.

### Example: Dimension a Y coordinate relative to the Origin of the drawing.

Choose the DIMENSION COORDINATE command in the Main Toolbox. Use the POINT XYZ command to set a point (Point 1) for the reference point for the dimension at **0,0,0** (the drawings origin). Move the cursor along the X and Y axes and set Point 2 at the coordinate to be measured. Set another point for the text location to the right of Point 2. Click the middle mouse button or press **Enter** to end the command.

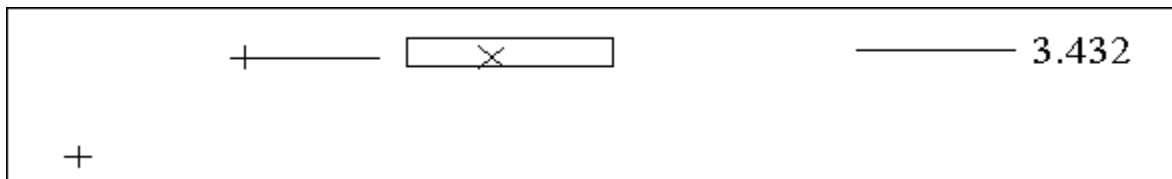

**Hint:** The Dimension Options folder gives you control over all options in DesignCAD's 12 dimension commands from a single menu. To use the Dimension Options folder, choose the OPTIONS command from the OPTIONS menu, and then click the Dimension tab. Select

---

the type of dimension command for which you would like to set the options from the Current Dimension Type box.

---

**See Also:** ***Dimension Command***

Menu: DIMENSION  
Menu Command: DIMENSION DIAMETER



Toolbox Icon:  
Point 1: Circle or arc to be dimensioned  
Point 2: Location for dimension information

The Dimension Diameter command draws a diameter dimension for a circle or arc. The text and arrowhead can be drawn outside the circle, inside the circle, or with an extension line.

### Using the Command

Choose the DIMENSION DIAMETER command in the Toolbox. Set a point on the circle or arc to be dimensioned. After the first point is set, a rubber-band line shows how the dimension will be drawn. Set a point for the location of the text information. The diameter of the circle is displayed at the last point.

### Options

The Dimension Diameter command has four options in the Command Line for the extension lines and arrowheads.

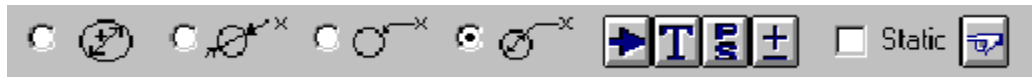

#### Text Inside Circle

- This option (above, far left) draws the dimension text and arrowheads inside the circle or arc.

#### Pre-Defined Extension Line

- This option (above, center left) draws the dimension text and arrowheads outside the arc or circle.

#### Custom Extension Line

- This option (above, center right) draws the dimension text and arrowheads outside the arc or circle with a custom extension line.

#### Dimension Inside Circle

- This option (above, right) draws the arrowheads inside the arc or circle.

**Hint:** The other options available in the Dimension Diameter command are also available in the Dimension command, and are accessed the same way. For details, refer to the “Dimension Command.”

---

### Example: Determine the diameter dimension of a circle.

Select the DIMENSION DIAMETER command from the Main Toolbox. Set a point on the circle. Set a second point for the text to the right of the circle. The diameter dimension is inserted into the drawing.

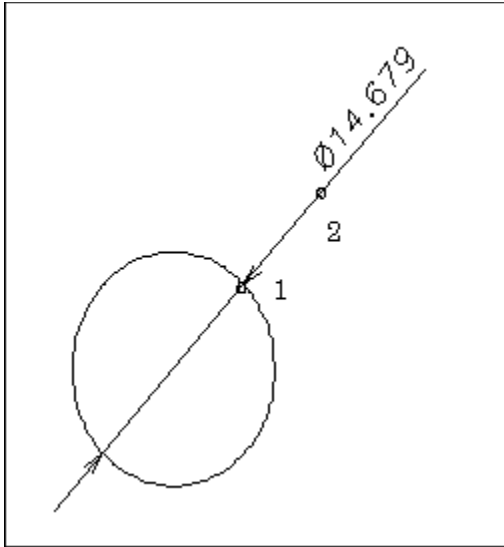

**Hint:** The Dimension Options folder gives you control over all options in DesignCAD's 12 dimension commands from a single menu. To use the Dimension Options folder, choose the OPTIONS command from the OPTIONS menu, and then click the Dimension tab. Select the type of dimension command for which you would like to set the options from the Current Dimension Type box.

---

**See Also:** *Dimension Command*

Menu: DIMENSION  
Menu Command: DIMENSION DISTANCE ONLY



Toolbox Icon:  
Point 1: Beginning of distance to be measured  
Point 2: End of distance to be measured  
Point 3: Location of dimension text

The Dimension Distance Only command measures a distance horizontally, vertically, or at any angle, but does not add extension lines or arrowheads.

### Using the Command

Choose the DIMENSION DISTANCE ONLY command in the Main Toolbox or the DIMENSION menu. You may choose which direction you wish to measure by selecting AUTO, FREE, X, Y or Z.

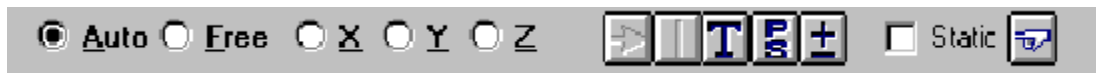

**Hint:** The other options available in the Dimension Distance Only command are also available in the Dimension command, and are accessed the same way. For details, refer to the “Dimension Command.”

---

Set a point for the beginning of the dimension. After the first point is set, a rubber-band box shows where the dimension text will be drawn. Set a point for the end of the dimension. Set a point for the location of the text information. The dimension is drawn without arrows or extension lines.

**Hint:** The Dimension Options folder gives you control over all options in DesignCAD's 12 dimension commands from a single menu. To use the Dimension Options folder, choose the OPTIONS command from the OPTIONS menu, and then click the Dimension tab. Select the type of dimension command for which you would like to set the options from the Current Dimension Type box.

---

**See Also:** *Dimension Command*

Menu: DIMENSION  
Menu Command: DIMENSION EXTENDED



Toolbox Icon:

Point 1-n: Points to be measured  
Point n+1: Location for dimension information

The Dimension Extended command draws successive dimensions extended along several points. Points are set for each measurement position. The distance measured is the vertical or horizontal distance between the measurement points. Each distance is measured separately between each successive pair of points.

### Using the Command

Choose the DIMENSION EXTENDED command from the Main Toolbox. Click the X, Y, or Z button to measure distances parallel to one of the axes, or choose FREE to measure dimensions in any direction.

**Hint:** The other options available in the Dimension Extended command are also available in the Dimension command, and are accessed the same way. For details, refer to the “Dimension Command.”

---

Next, set a point for each measurement position. Then set a point for the location of the dimension information. Press **Enter** to end the command. Dimensions will be drawn for the measurement points.

### Example: Dimension a wall.

Select the DIMENSION EXTENDED command from the DIMENSION menu or the Main Toolbox. Choose the X box option in the command line. Set a point on the bottom-left corner of the wall. Set a second point near the middle of the wall, along the bottom. Set a third point on the bottom-right corner of the wall. Set a fourth point for the text below the wall. Press **Enter**. The dimension is added to the drawing in two sections.

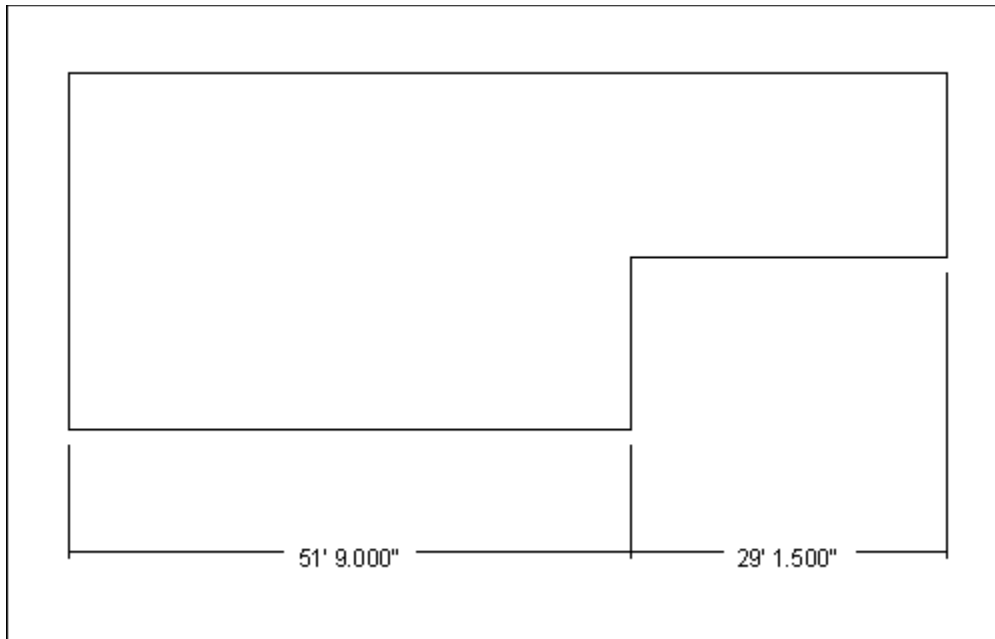

**Hint:** The Dimension Options folder gives you control over all options in DesignCAD's 12 dimension commands from a single menu. To use the Dimension Options folder, choose the OPTIONS command from the OPTIONS menu, and then click the Dimension tab. Select the type of dimension command for which you would like to set the options from the Current Dimension Type box.

**See Also:** *Dimension Command*

Menu: OPTIONS  
Menu Command: OPTIONS

The Dimension Options folder gives you control over the many options in DesignCAD's 12 dimension commands, plus the Pullout and Balloon commands, all from one menu.

## Using the Command

Choose the OPTIONS command from the OPTIONS menu, and then click the DIMENSION tab to bring up the Dimension Options folder. Click in the Current Dimension Type box and select the type of dimension command for which you want to set the options.

Once the settings are changed, click OK to accept them.

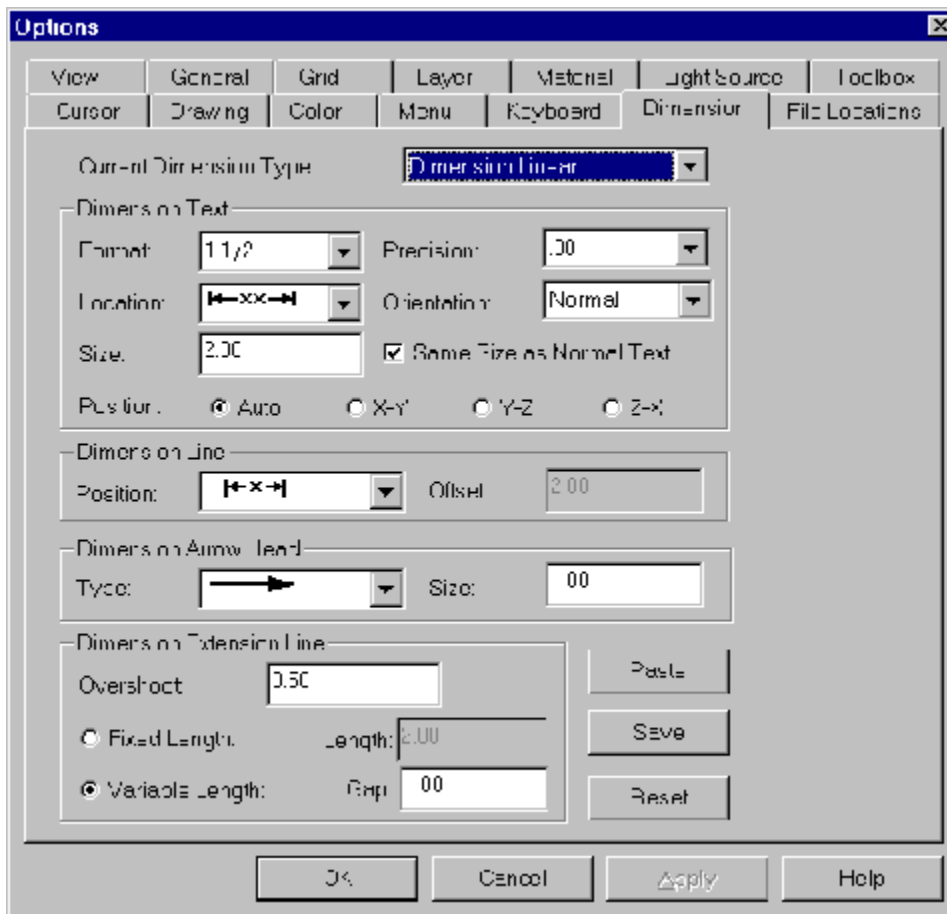

## Paste

After setting the options for a particular dimension command, click on the PASTE button to apply the same options to similar dimensioning commands. If you have set the options for a dimensioning command that measures an angular dimension, the same options will be used for all dimensioning commands that make angular measurements. Likewise, If you have set the options for a dimensioning command that measures a linear dimension, the same options will be used for all dimensioning commands that make linear measurements.



## **Save**

If you want to save the changes to the next drawing session, click the *SAVE* button before you click *OK*.

## **Reset**

The *RESET* button restores all of the options for the command specified in the *Current Dimension Type* box to their default values.

For more detailed *Dimension Options* information, refer to the individual entries listed in the "*Command Reference*" section of this manual. *Dimension* entries include:

- Balloon Command
- Dimension Command
- Dimension Angle Command
- Dimension Arc Command
- Dimension Baseline Command
- Dimension Chamfer Command
- Dimension Coordinate Command
- Dimension Diameter Command
- Dimension Distance Only Command
- Dimension Extended Command
- Dimension Progressive Command
- Dimension Radius Command
- Dimension Radius Progressive Command
- Pullout Command

Menu: DIMENSION  
Menu Command: DIMENSION PROGRESSIVE

Toolbox Icon: 

Point 1: Base point  
Points 2-n: Points to be measured  
Point n+1: Location for text

The Dimension Progressive command draws the dimensions of a line progressively from a base point. The distance measured is the vertical or horizontal distance between each measurement point and the base point.

### Using the Command

Choose the DIMENSION PROGRESSIVE command from the Main Toolbox or the DIMENSION menu. Select HOR or VER to determine whether the horizontal or vertical distance will be dimensioned.

**Hint:** The other options available in the Dimension Progressive command are also available in the Dimension command, and are accessed the same way. For details, refer to the “Dimension Command.”

---

Set a point for the base measurement point. Set points for the other measurement points. A rubber-band line shows how the dimension will be drawn. Finally, set a point for the location of the dimension text. Then press **Enter** to end the command. The dimension is drawn from the base point to each measurement point.

### Example: Draw progressive dimensions for an object.

Select the DIMENSION PROGRESSIVE command. Choose the HOR option to measure the horizontal distance for the object you are going to dimension. Next, set a base point at one end of the object. Set additional points as needed for the steps you want to measure. Then set a point for the text and press **Enter**. The progressive dimensions of the object are calculated from the first point and inserted into the drawing.

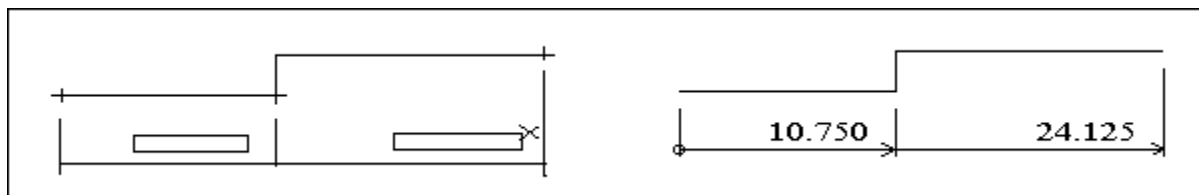

**Hint:** The Dimension Options folder gives you control over all options in DesignCAD's 12 dimension commands from a single menu. To use the Dimension Options folder, choose the OPTIONS command from the OPTIONS menu, and then click the Dimension tab. Select the type of dimension command for which you would like to set the options from the Current Dimension Type box.

---

**See Also:** *Dimension Command*

Menu: DIMENSION  
Menu Command: DIMENSION RADIUS



Toolbox Icon:  
Point 1: Circle or arc to be dimensioned  
Point 2: Location for dimension information

The Dimension Radius command dimensions the radius of a circle or arc.

## Using the Command

Choose the DIMENSION RADIUS command from the Main Toolbox or the DIMENSION menu. To have the dimension arrowhead drawn inside the circle, click the PRE-DEFINED EXTENSION button in the Command Line.

## Options

- The Dimension Radius command has four options in the Command Line for the extension lines and arrowheads.



### Dimension Inside Circle

- This option (above far left) draws the dimension text and arrowheads inside the circle or arc.

### Pre-Defined Extension Line

- This option (above center left) draws the dimension text outside the arc or circle, with the arrow inside.

### Custom Extension Line

- This option (above center right) draws the dimension text and arrowheads outside the arc or circle with a custom extension line.

### Dimension Outside Circle

- This option (above right) draws a reference line from the center of the arc or circle to the perimeter, and the text and arrowheads are placed outside the arc or circle.

**Hint:** The other options available in the Dimension Radius command are also available in the Dimension command, and are accessed the same way. For details, refer to the “Dimension Command.”

---

Set a point on the circle or arc to be dimensioned. After the first point is set, a rubber-band line shows how the dimension will be drawn. Set a point for the location of the text information. The radius of the circle is displayed at the last point.

## Example: Insert a dimension with the Dimension Radius command.

Choose the DIMENSION RADIUS command. Set a point on the circle or arc to be dimensioned. Set

a second point for the location of the text. The dimension information is calculated and inserted into the drawing.

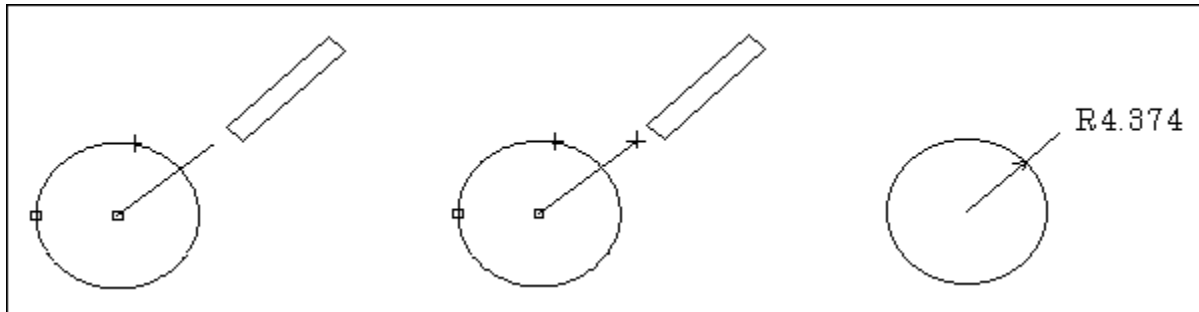

**Hint:** The Dimension Options folder gives you control over all options in DesignCAD's 12 dimension commands from a single menu. To use the Dimension Options folder, choose the OPTIONS command from the OPTIONS menu, and then click the Dimension tab. Select the type of dimension command for which you would like to set the options from the Current Dimension Type box.

**See Also:** *Dimension Command*

Menu: DIMENSION  
Menu Command: DIMENSION RADIUS PROGRESSIVE

Toolbox Icon: 

Point 1: Base point  
Points 2-n: Points to be measured  
Point n+1: Location for text

The Dimension Radius Progressive command draws radius dimensions progressively. Points are set for each measurement position. The dimension of the radius is calculated and inserted into the drawing using progressive measurements. Each distance is measured from the base point.

### Using the Command

Choose the DIMENSION RADIUS PROGRESSIVE command from the Main Toolbox or the DIMENSION menu.

**Hint:** The other options available in the Dimension Radius Progressive command are also available in the Dimension command, and are accessed the same way. For details, refer to the “Dimension Command.”

---

Set a point for the base point. Set points for the other measurement points. Set a point for the text location. Click the middle mouse button or press **Enter**.

### Example: Draw the progressive dimensions of a radius.

First, select the DIMENSION RADIUS PROGRESSIVE command from the Main Toolbox or the DIMENSION menu. Next, set a base point at the center of the object to be dimensioned. Set one or more points for measurement. Then set a point for the text location. Press **Enter**, and the dimension of the radius is calculated from the first point to each successive point and inserted into the drawing.

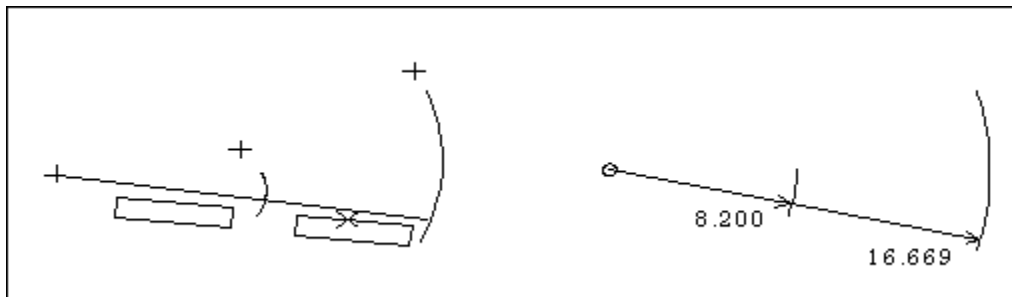

**Hint:** The Dimension Options folder gives you control over all options in DesignCAD's 12 dimension commands from a single menu. To use the Dimension Options folder, choose the OPTIONS command from the OPTIONS menu, and then click the Dimension tab. Select the type of dimension command for which you would like to set the options from the Current Dimension Type box.

---

**See Also:** *Dimension Command*



Menu:                    OPTIONS  
Menu Command:    DISPLAY GRID

The Display Grid command shows a grid on the drawing screen which can be used as a reference for drawing new objects or comparing the size of existing objects.

### **Using the Command**

Choose DISPLAY GRID in the OPTIONS menu. The Grid immediately becomes visible on the drawing screen. You can change the size of the grid units, the extent of the grid, the grid plane, and the grid color in the GRID options folder available through the OPTIONS command in the OPTIONS menu.

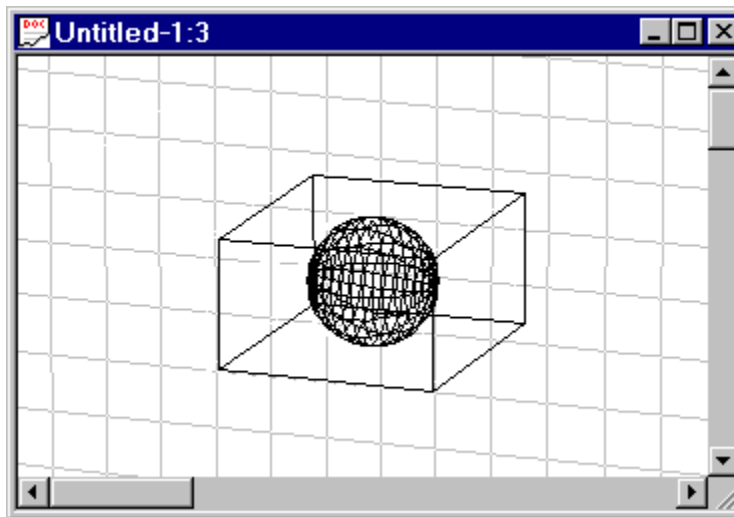

***See Also: Grid Options***

Menu: HELP  
Menu Command: DRAWING INFO

The Drawing Info command displays the number of entities and points in a drawing, along with various other information.

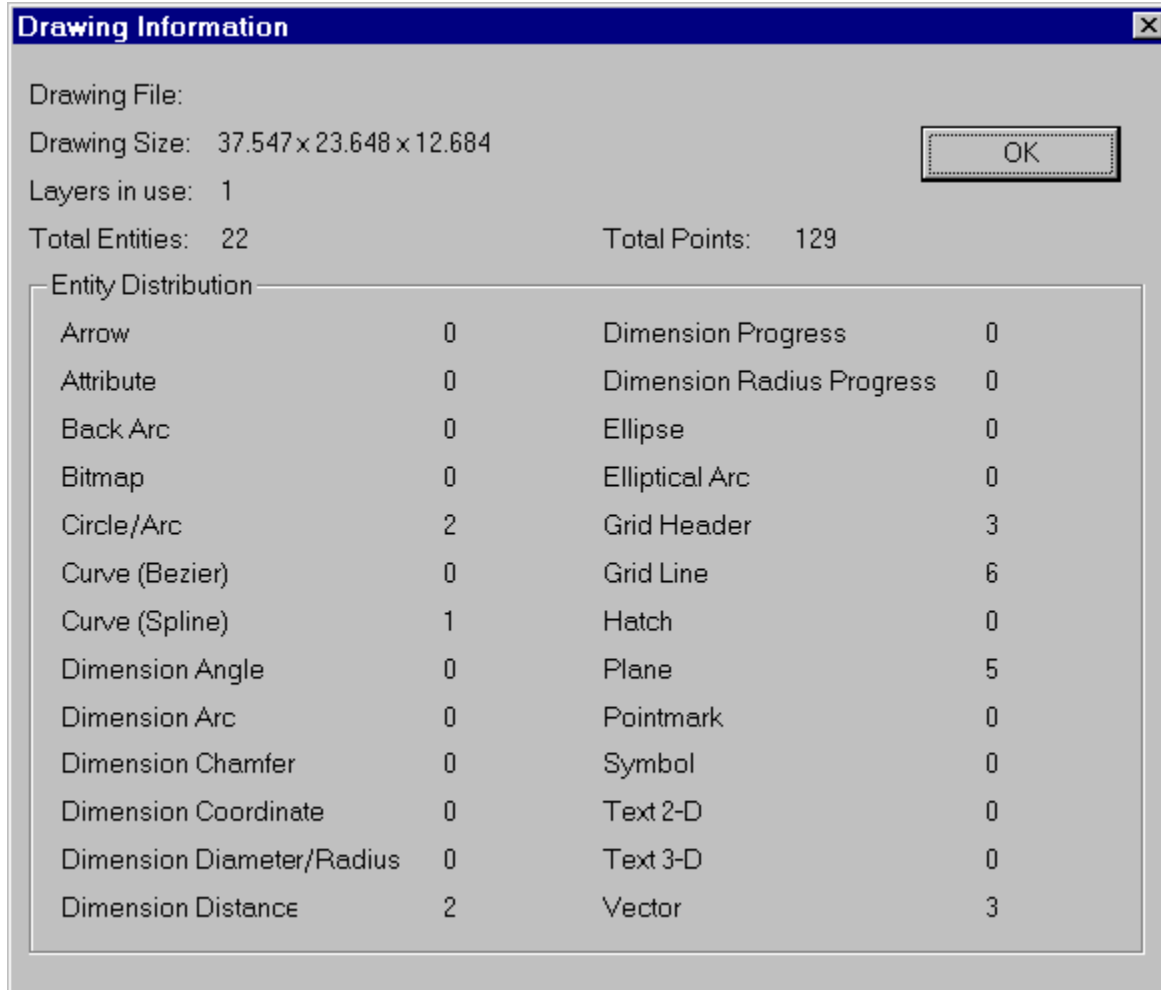



Menu: OPTIONS  
Menu Command: OPTIONS  
Shortcut Key: Q

In the Text Options folder, you can change the options for how text and attribute text will be drawn.

### Using the Command

Choose the OPTIONS command from the OPTIONS menu. Click the TEXT tab to bring up the Text Options folder.

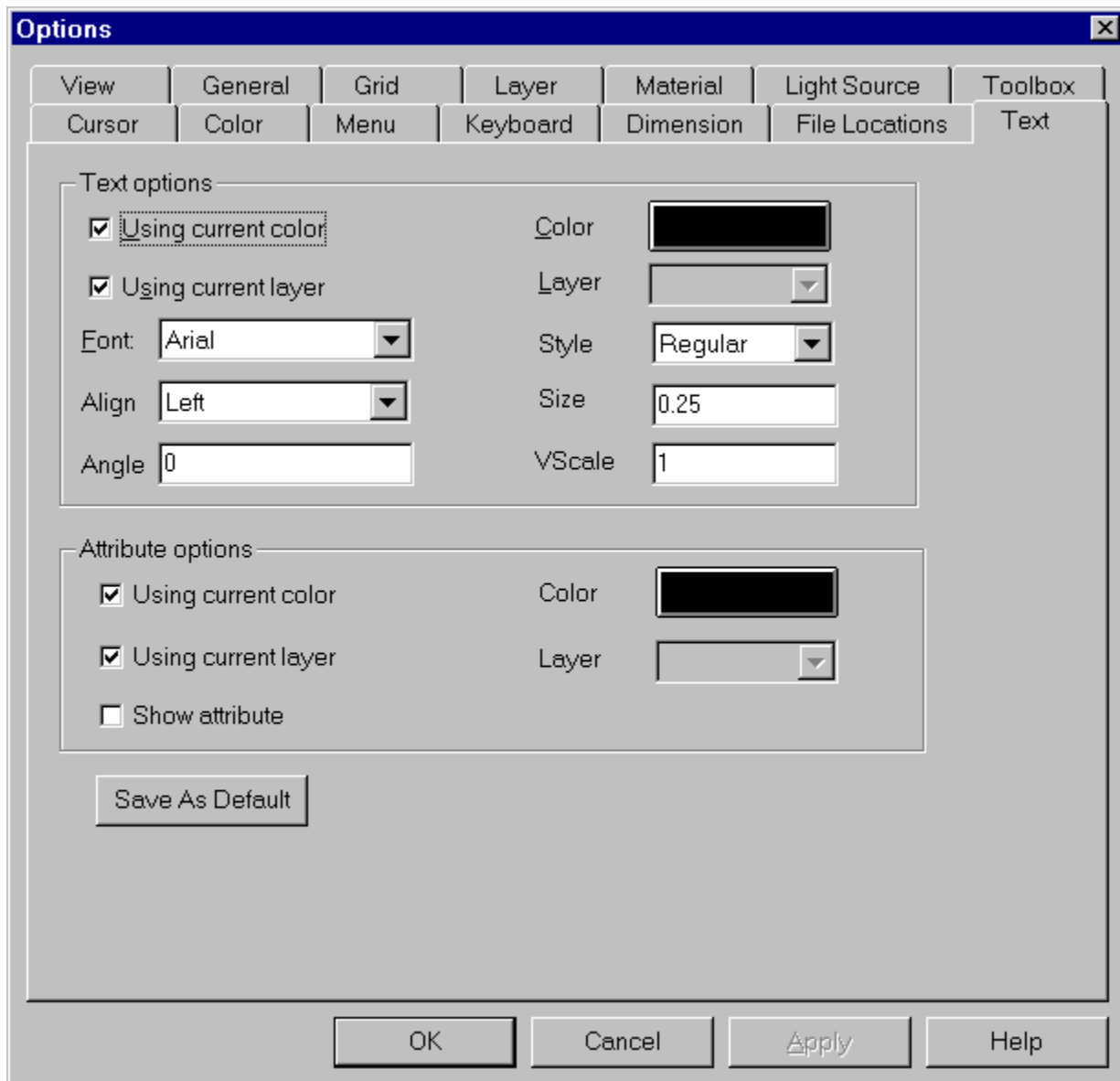

### Text Options

Using Current Color

When this option is selected, text is drawn with the current drawing color. If you are drawing with several different colors and want all text to be drawn with the same color, uncheck the USING CURRENT COLOR checkbox and click the COLOR box; the Color Palette appears. Click on the color you want to use for text and click OK.

#### Using Current Layer

This option determines the layer in which text is drawn. When the Using Current Layer option is checked, all text (excluding Dimension and Attribute) is drawn in the active layer. To draw all of the text in the same layer of a multi-layer drawing, uncheck the USING CURRENT LAYER box and click the LAYER box. Select the layer you want normal text to be drawn in and click OK.

#### Font

Select the font to be used for text from this list box.

#### Align

Select Left, Center, or Right alignment from this list box.

#### Angle

Enter the angle at which text will be drawn in this box.

#### Style

Select Regular, Bold, Italic, or Bold Italic from this list box.

#### Size

Enter the size for text in this box.

#### VScale

Enter the VScale for text in this box. A large value for VScale will make tall, thin letters; conversely, a small value for VScale will make short, thick characters.

### **Attribute Options**

#### Using Current Color

When this option is selected, Attribute Text is drawn with the current drawing color. If you are drawing with several different colors and want all Attribute Text to be drawn with the same color, uncheck the USING CURRENT COLOR checkbox and click the COLOR box; the Color Palette appears. Click on the color you want to use for Attribute Text and click OK.

#### Using Current Layer

This option determines the layer in which the Attribute Text is drawn. When the Using Current Layer option is checked, all Attribute Text is drawn in the active layer. To draw all of the Attribute Text in the same layer of a multi-layer drawing, uncheck the USING CURRENT LAYER box and click the LAYER box. Select the layer you want Attribute Text to be drawn in and click OK.

#### Show Attributes

This option displays or hides the attributes in a drawing.

### **Save as Default**

If you want to save the changes to the next session, select the SAVE AS DEFAULT option. Click OK when you are finished.

***See Also: Options Command***

Menu: EDIT  
Submenu: SELECTION  
Menu Command: DUPLICATE  
Shortcut Key: **N**  
Point 1: Handle 1 sets location for the copy  
Point 2: Handle 2 sets angle and scale for the copy (optional)  
Point 3: Handle 3 sets orientation for the copy (optional)

The Duplicate command makes a copy of the current selection. The command does not use the Windows Clipboard, so any contents in the Clipboard are not erased or changed.

### **Using the Command**

Select an object or objects, and then choose the DUPLICATE command. One, two, or three points may be used to specify the location where the copy is to be located.

The first handle of the selection is positioned at the first point set with this command. If you have placed two or three drawing handles, then you can place and scale the duplicate by those points. Otherwise, the first point you place will make a duplicate with the same orientation and size as the selection.

If a second point is used, the selection's size and angle is adjusted so that the secondary handle is located at the second point. If only one point is used, the selection will be placed at its original size and angle.

If a third point is used, the selection will be positioned at an angle so that the three Block handles lie on the same plane as the three points set.

You can also activate this command by moving the cursor onto the primary handle of an object, then holding down **Ctrl** and clicking the left mouse button to lock the Duplicate command.

This command is like the Move command, except that the selection is copied instead of moved.

### **Example: Make a copy of an object in your drawing.**

Select the object and choose the DUPLICATE command. Move the cursor to the location for the copy. Set a point for the insertion. If you have set more than one handle for the object, then set a point for each handle.

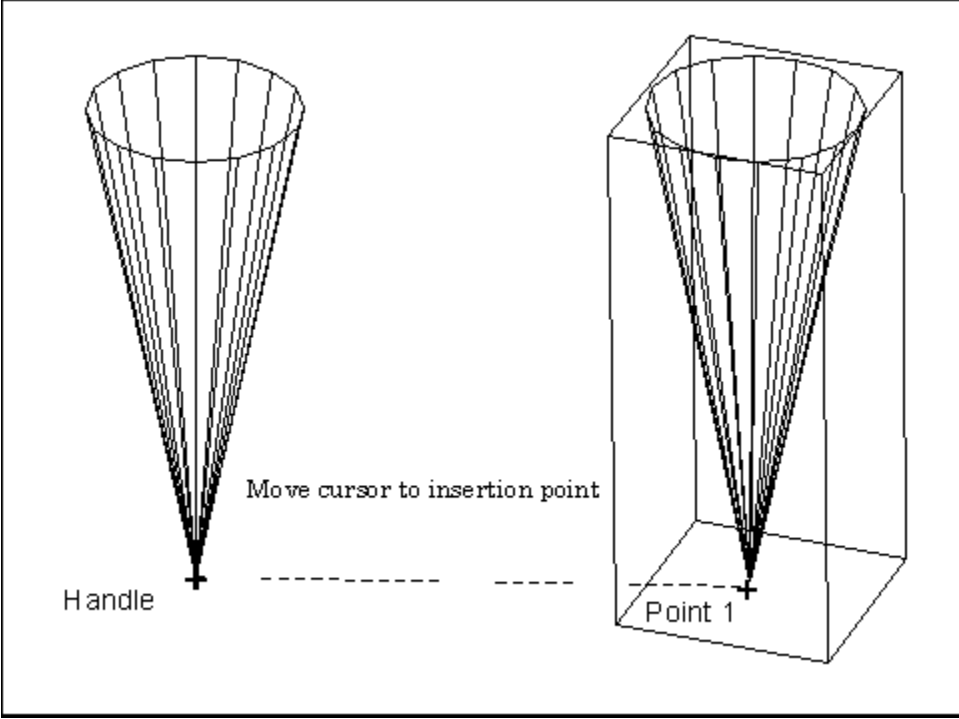

Menu: DRAW  
Submenu: CIRCLE/ELLIPSE  
Menu Command: ELLIPSE

Toolbox Icon: 

Point 1: Center of the ellipse  
Point 2: One axis of the ellipse  
Point 3: Point through which the ellipse passes

The Ellipse command draws an ellipse or oval. Points are set for the center and axes.

### Using the Command

Choose the ELLIPSE command in the Main Toolbox. Set a point for the center of the ellipse. After the first point is set, a rubber-band ellipse shows how the ellipse will be drawn. Set a point for one axis of the ellipse. Set a point through which the ellipse passes. An ellipse will be drawn passing through the second and third points with its center at the first point.

### Example: Draw an ellipse.

Choose the ELLIPSE command. Set a point for the center of the ellipse. Then set a point up and to the left of the first point. This point is one axis. Next, set a third point to the right of the second point. The ellipse is drawn, passing through this point and using all three points.

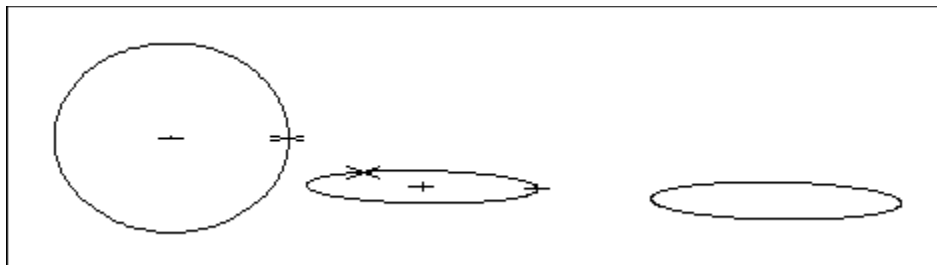

**See Also:** *Elliptical Arc Command*

Menu: DRAW  
Submenu: ARC/ELLIPTICAL ARC  
Menu Command: ELLIPTICAL ARC

Toolbox Icon: 

Point 1: Center of the ellipse  
Point 2: Beginning of the arc  
Point 3: End of the arc

The Elliptical Arc command draws an elliptical arc, or part of an ellipse or oval, between two points.

### Using the Command

Choose the ELLIPTICAL ARC command in the Main Toolbox. Set a point for the center of the arc. Set a point for the beginning of the arc. After the second point is set, a rubber-band arc shows how the arc will be drawn. Set a point for the end of the arc. An elliptical arc is drawn from the second point, counterclockwise around the ellipse to the third point.

### Example: Draw an elliptical arc.

Choose the ELLIPTICAL ARC command. Set a point for the center of the arc. Next, set a point to the left of the first point. Set a third point to the right of the first point. An elliptical arc is drawn through these points.

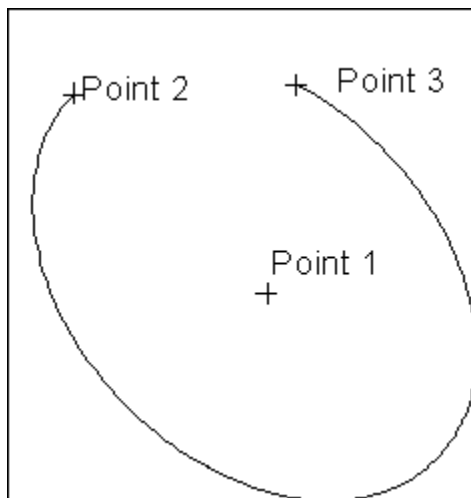

**See Also:** *Ellipse Command*

Menu: EDIT  
Menu Command: ENTITY SELECT

The Entity Select command selects all entities in the drawing of specified types.

### Using the Command

When you activate the ENTITY SELECT command, a dialog box displays a list of all entity types. The types of entities in your drawing are available for selection. Select the box beside each entity you want to select. The boxes for entities that are not in your drawing are grayed out.

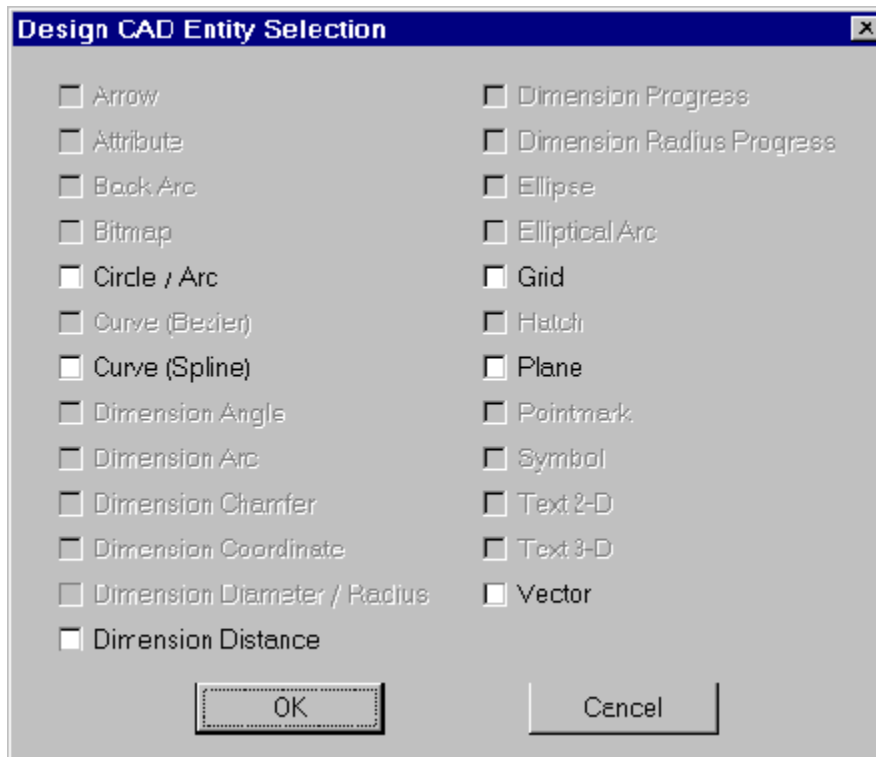

All entities in the drawing that match the chosen entity types will be selected. The selection handle is placed at the geometric center of the group. If you need to move the selection handle, choose the Set Handles command.

### Example: Select all the curves in the drawing.

Choose the ENTITY SELECT command and click on the CURVE checkbox. Then click OK. All of the curves in your drawing will be selected.



Menu: EDIT  
Menu Command: ERASE  
Shortcut Key: **Del**

The Erase command deletes selected entities from the drawing. You must first select the entity you want to erase, and then choose the Erase command.

**Example: Remove an object from a drawing.**

Select an item in the drawing you want to erase. Then choose the ERASE command. The item is erased from the drawing.

Menu: EDIT  
Menu Command: ERASE LAST  
Shortcut Key: **Ctrl+E**

The Erase Last command deletes the most recently drawn entity from the drawing.

### **Using the Command**

When you choose the Erase Last command, the most recently drawn entity is removed from the drawing. Each subsequent time you use this command, it erases the next most recently drawn entity, working its way from last to first entity drawn in that session.

The Erase Last command pays attention only to the order in which entities were drawn originally. It does not acknowledge modifications to existing entities or undo them, but erases entire entities.

**Example:** Erase the last two items added to the drawing.

Choose the ERASE LAST command twice. DesignCAD erases the last object and the next to the last object.

**Hint:** To undo a modification, use the UNDO command.

---

Menu: FILE  
Menu Command: EXIT  
Shortcut Key: **Alt+F4**

The Exit command closes DesignCAD 97 for Windows 95.

### Using the Command

Choose the EXIT command. If you have any unsaved drawings open, the program gives you the opportunity of saving each one before the program closes.

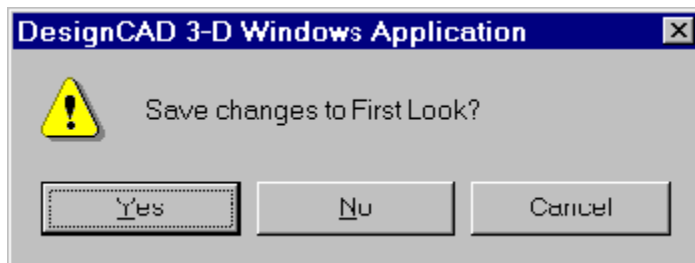

Choosing YES activates the Save As command. Choosing NO closes the program (or prompt you to save the next drawing if more than one were open). Choosing CANCEL returns you to the DesignCAD drawing screen with no change.

Menu: EDIT  
Submenu: SELECTION  
Menu Command: EXPLODE

The Explode command converts any selected composite objects into separate entities. This command affects grids, dimensions, and symbols. Afterwards, the parts of the former composite objects can be manipulated individually.

Symbols are broken apart into separate drawing entities, just as if they had been drawn originally right in the current drawing. Grids are converted into planes, and planes are converted to vectors. Dimensions are converted into text, vectors, and arrows.

### **Using the Command**

Select the object(s) to be exploded. Choose EXPLODE from the EDIT | SELECTION submenu. The entities can be selected separately.

### **Example: Explode a symbol.**

Load a symbol in a drawing and select the symbol. Choose EXPLODE from the EDIT | SELECTION menu. The Symbol will be separated into the entities that make it up.

Menu: FILE  
Submenu: EXPORT  
Menu Command: EXPORT*format*

The Export command lets you export files in several formats.

### Using the Command

Choose the format type in the FILE|EXPORT submenu. The SAVE box appears. In the FILE NAME box enter the name of the file to export. In the SAVE IN box tell the program where to store the exported drawing. When you have entered the information, choose the **Save** button to save and export the drawing. Choose the CANCEL button to return to the drawing without exporting it.

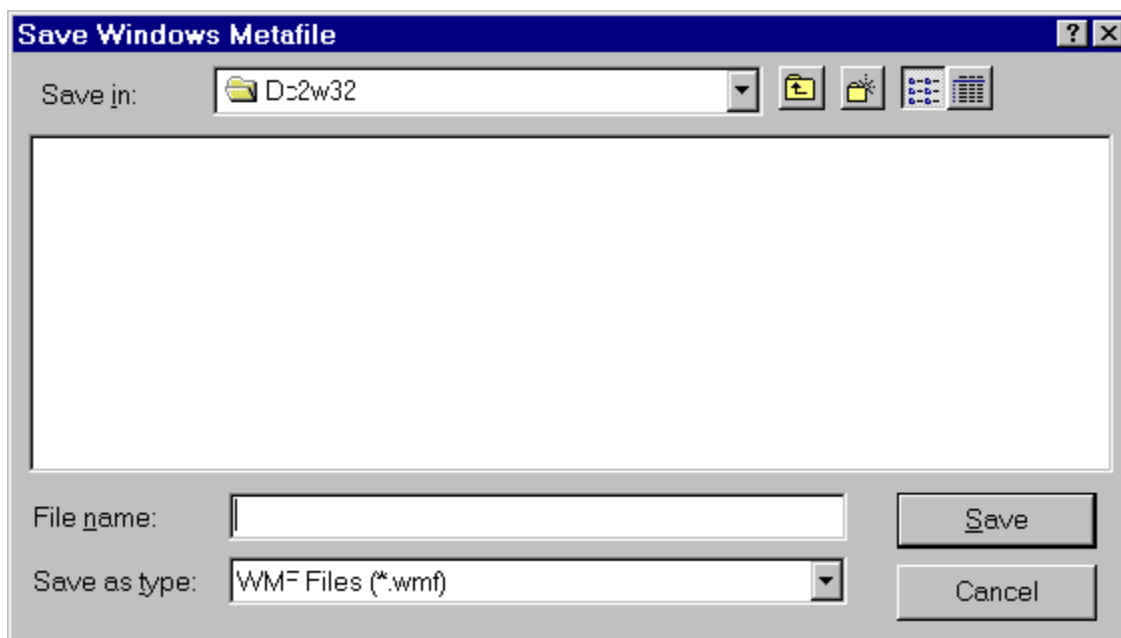

#### DWG

DesignCAD can export your drawing in DWG format.

#### AutoCAD Drawing Interchange (DXF)

DXF files can be used with many other Windows applications.

#### Initial Graphics Exchange Specifications (IGES)

The IGES format is a standard format that many CAD systems support.

#### Windows Metafile (WMF)

Many Windows applications can read Windows Metafiles.

#### WordPerfect Graphic (WPG)

DesignCAD can export files in the WordPerfect .WPG format.

#### RenderMan (RIB)

Export to the RenderMan rendering package.

VRML (WRL)

The WRL format is for Internet graphic files that can be read by any 3D web browser.

**Example: Export a drawing as a Windows Metafile.**

Choose the EXPORT WINDOWS METAFILE command. The SAVE WINDOWS METAFILE box appears. Choose a path and file name for the file and click OK. The drawing is converted into .WMF format and saved. Now you can open a word processing program, desktop publishing program, or other application that imports graphics. Import the Windows Metafile into the application.

Menu: DRAW  
Menu Command: EXTRUDE  
Shortcut Key: X

Toolbox Icon: 

Point 1-n: Distance and direction for the extrusion path

The Extrude command extends a two-dimensional object into three dimensions, connecting it from one point to another with surfaces. For example, you can extrude a floor plan upward to make the walls of a house, or you can extrude a circle to make a pipe or bar.

### Using the Command

Select the object to be extruded and choose the EXTRUDE command. Set one or more points for the object to be extruded to. The object is extruded so the selection handle is placed at each point set.

You can specify an extrusion scale to make the resulting object increase or decrease in size. The scale is the amount of change in size of the extruded object from the first point to the last.



Varying scale can be used to specify the scale at each point along the extrusion, if there is more than one point. If varying scale is used, you can specify the scale for each point. The scale is relative to the extruded object's original size and not necessarily to its size at the previous point.

### Example: Select an object used for a mold or cross-section.

Now pick the EXTRUDE command from the DRAW menu. Set two or more points: a reference point and one or more points representing the extrusion path. The path does not have to be in a straight line.

The reference point represents the location of the selected object's handle. The other points represent the distance and direction of the extrusion points. They form a parallel to the actual extrusion path.

The object does not move to the reference point. Instead, the extrusion always starts at the current location of the object. Therefore, it is most convenient just to set the reference point on the handle of the object. Press **Enter** when you have set all the points.

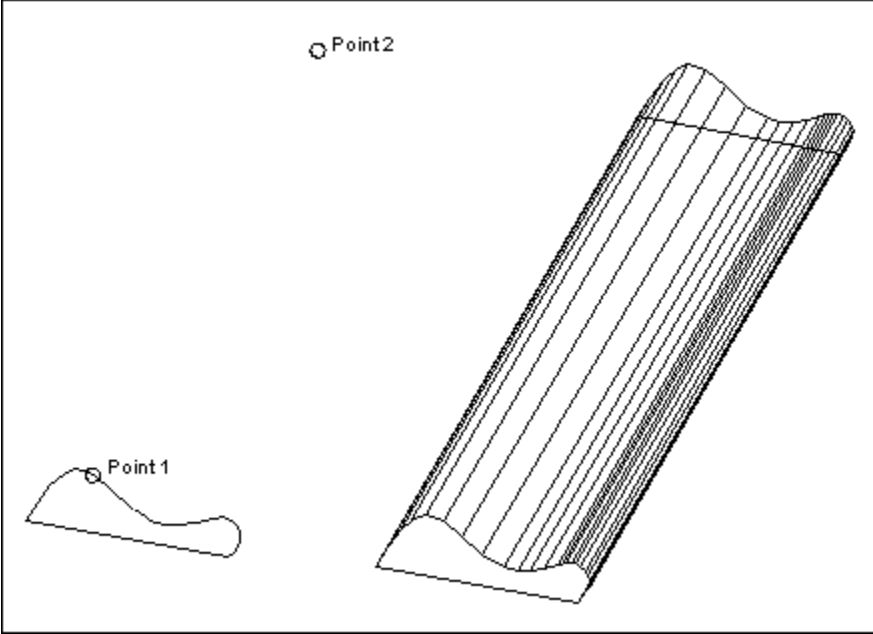



Menu: OPTIONS  
Menu Command: OPTIONS

In the File Location Options folder, you can modify where DesignCAD stores the various files it uses and produces. This gives you complete control over file placement, no matter how many hard drives or drive partitions you may have on your computer.

### Using the Command

Choose the OPTIONS command from the OPTIONS menu, and then click the FILE LOCATIONS tab to bring up the File Location Options folder.

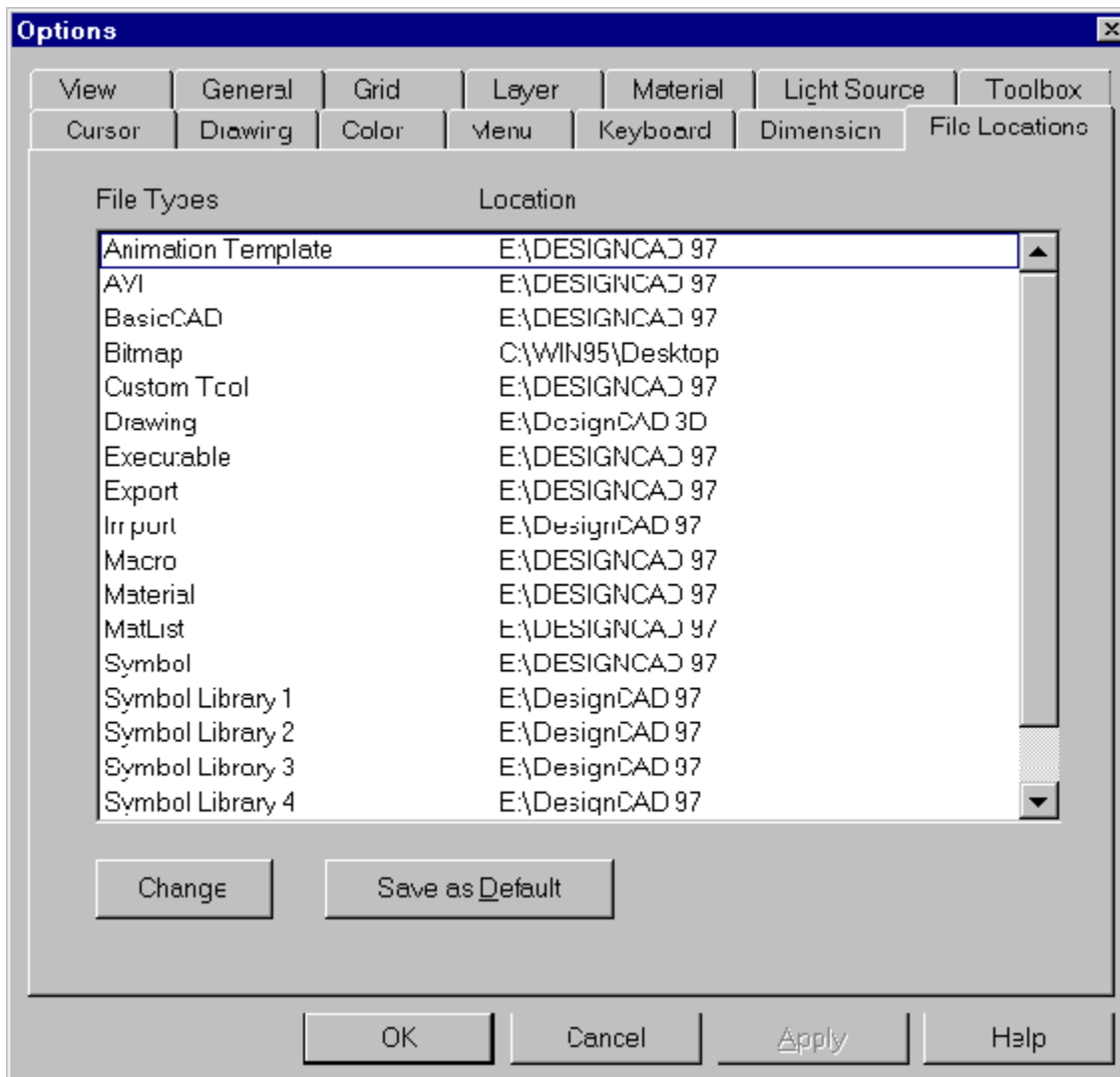

Scroll through the list of file paths and highlight the file path you want to modify, then click the CHANGE button. The Path box appears.

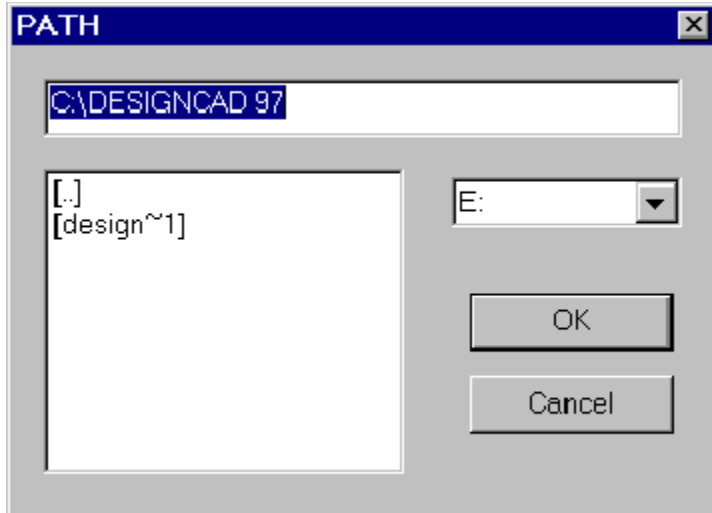

In the Drive box, click the arrow button to scroll through the list and select the drive that contains the folder or directory you want to use. In the Folder box, scroll through the list and select the name of the folder you want to use. The full path you have selected appears in the box at the top of the Path Selection box. When the path is correct, click OK to change it.

The File Locations Options tab now displays the new path you selected in the list of file paths. To use the new path, click OK.

Now, when you tell DesignCAD to use or save a particular type of file, it will look for or save that type of file in the new folder location you selected.

Menu: EDIT  
Submenu: TRIM/EXTEND  
Menu Command: FILLET  
Shortcut Key: **F**  
Point 1: A point on one of the lines to be filleted  
Point 2: A point on the second line to be filleted

The Fillet command rounds a corner of a plane or two lines.

### Using the Command

Choose the FILLET command. In the Fillet Radius box in the Command Line enter the radius of the curve to be drawn. Set a point on one of the lines to be filleted, then a point on the other. If the lines are not connected, DesignCAD connects them at the points, using the radius you have set.



### Example: Round off the corner of a rectangular plane to a radius of three Drawing Units.

Choose the FILLET command and enter **3** in the FILLET RADIUS box. Set a point near one corner of the plane, and a second point on the other side of the corner. The corner is rounded off to a radius of three.

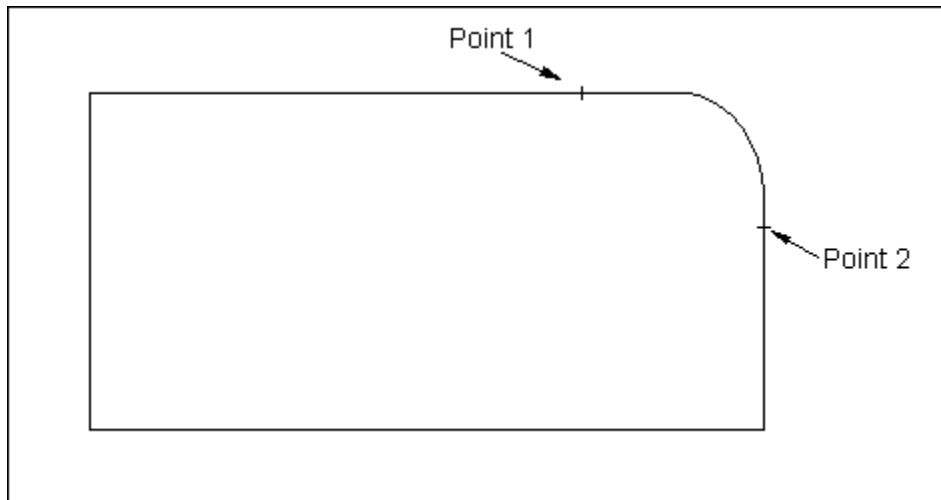

**See Also:** *Fillet Corner Command*

Menu: EDIT  
Submenu: TRIM/EXTEND  
Menu Command: FILLET CORNER  
Point 1: Corner to be filleted

The Fillet Corner command allows you to round off rectangular corners of solids. You can specify the fillet radius and the number of facets to use on each rounded edge:

Fillet radius:	<input type="text" value="7"/>	No. of Facets:	<input type="text" value="8"/>
----------------	--------------------------------	----------------	--------------------------------

### Using the Command

Choose the FILLET CORNER command. In the Command Line enter the amount of the radius in the FILLET RADIUS box and the number of facets in the NO. OF FACETS box. Then set a point on the corner to be filleted.

**Note:** You cannot use this command to round a corner where more than three faces meet, such as the point of a cone.

---

### Example: Round the corner off of a box.

Select the FILLET CORNER command. Move the cursor near the corner you want to fillet and set a GRAVITY point by clicking the right mouse button or pressing the . (period) key. The corner is filleted to the radius specified in the Command Line.

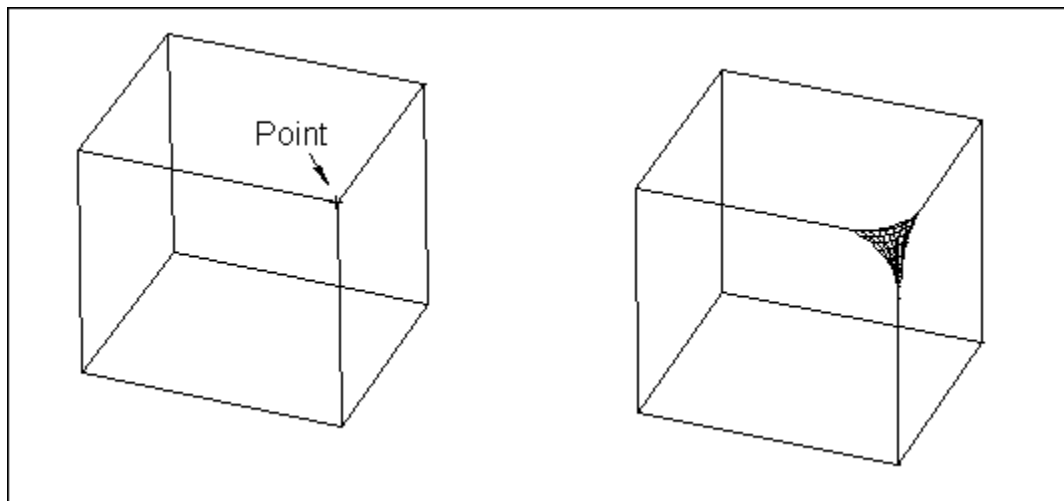

Menu: EDIT  
Submenu: TRIM/EXTEND  
Menu Command: FILLET EDGE  
Point 1: Edge to be filleted

The Fillet Edge command quickly and easily rounds off rectangular edges of solid objects. You may specify the number of facets for the rounded edge and the radius for each end of the edge to be filleted.

### Using the Command

Choose the FILLET EDGE command. The Command Line shows three boxes. Enter the radius for the beginning of the edge in the 1ST FILLET RADIUS box. Enter the radius for the end of the edge in the 2ND FILLET RADIUS box. In FACETS box enter the number of facets you want the edge to have. Return to the drawing screen. Then set a point on the edge (not at a corner) you want to fillet.

**Note:** The Fillet Edge command requires flat edges. Once you have filleted an edge of a cube, for example, the adjacent edges no longer meet at a flat face but at a curved surface. So the edges adjacent to a filleted edge cannot also be filleted.

---

### Example: Round off the rectangular edge of a solid.

Choose the FILLET EDGE command and enter the values for the radius of each fillet and the facets in the Command Line. Set a point on the edge to be filleted. DesignCAD fillets the edge according to the values.

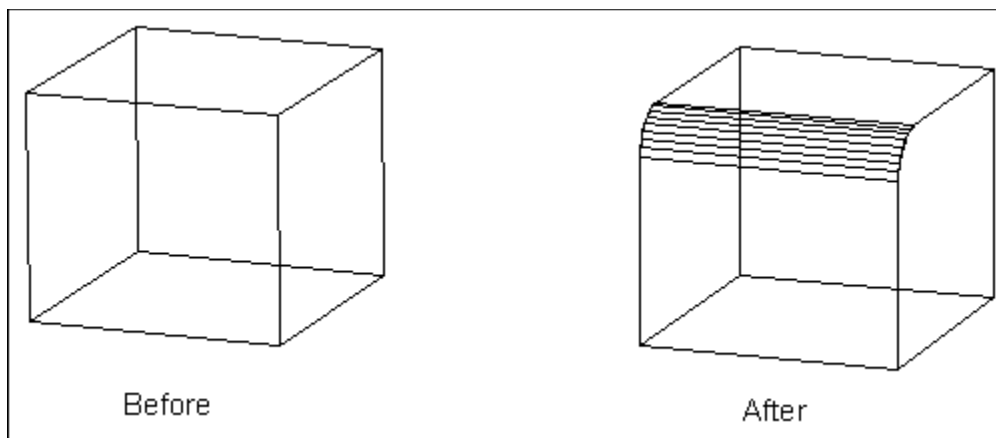

Menu: VIEW  
Menu Command: FIT TO WINDOW  
Shortcut Key: **Ctrl+W**

This command zooms the active view window so that the entire drawing is centered on the screen with all objects visible.

### Using the Command

Choose the FIT TO WINDOW command. The drawing is then centered on the screen with all the objects in view.

Suppose you have several entities in your drawing that are outside the current view, or a single entity drawing that you want to center and zoom in on. The Fit to Window command brings them all into view, showing you the closest zoom possible of the entire drawing in the current view.

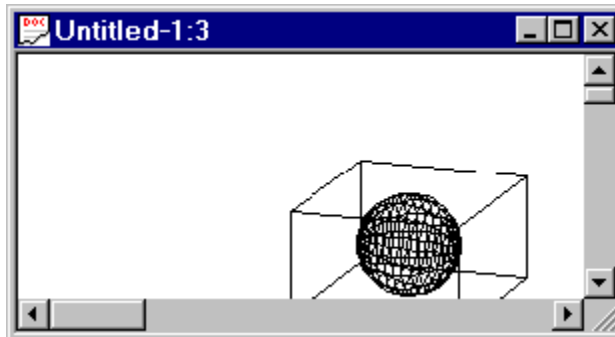

**Before**

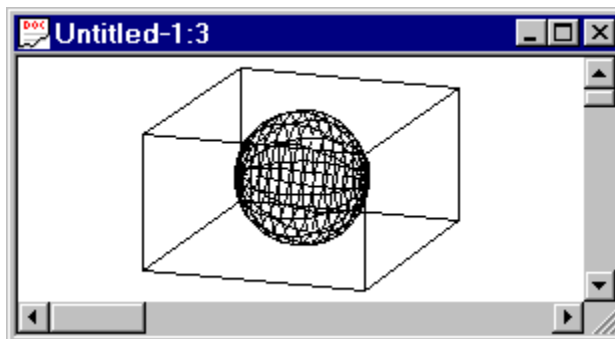

**After**

Menu: VIEW  
Menu Command: FIT TO ALL WINDOWS  
Shortcut Key: **Ctrl+Shift+W**

This command zooms all the view windows so that the entire drawing is centered on the screen with all drawn objects visible.

### Using the Command

Choose the FIT TO ALL WINDOWS command. The program then redraws all the objects in the drawing so they are visible in each open window.

For example, if you have several entities in your drawing that are outside of the current view, or a single entity drawing that you want to center and zoom in on. The Fit to All Windows command brings them all into view, showing you the closest zoom possible of the entire drawing in all active views.

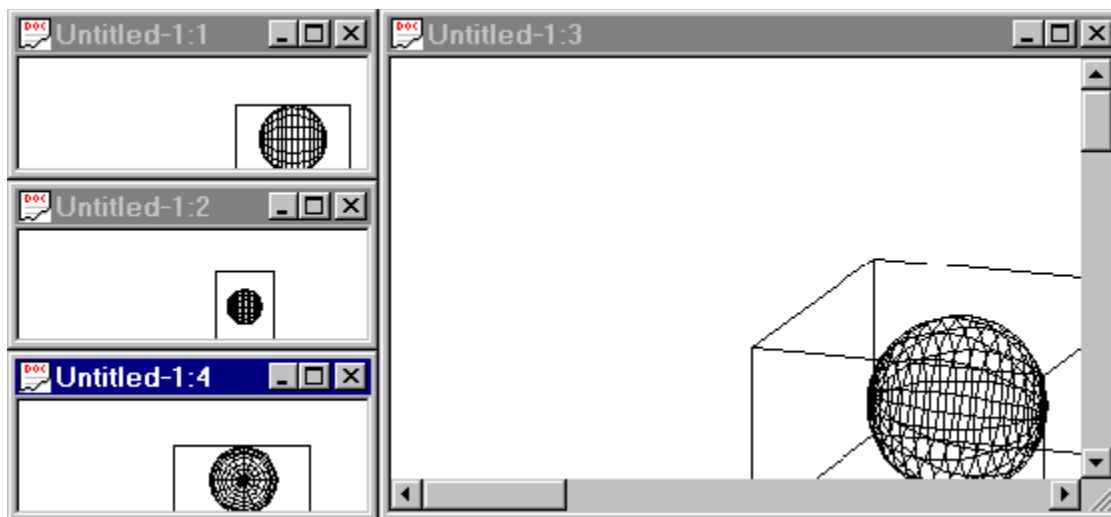

**Before**

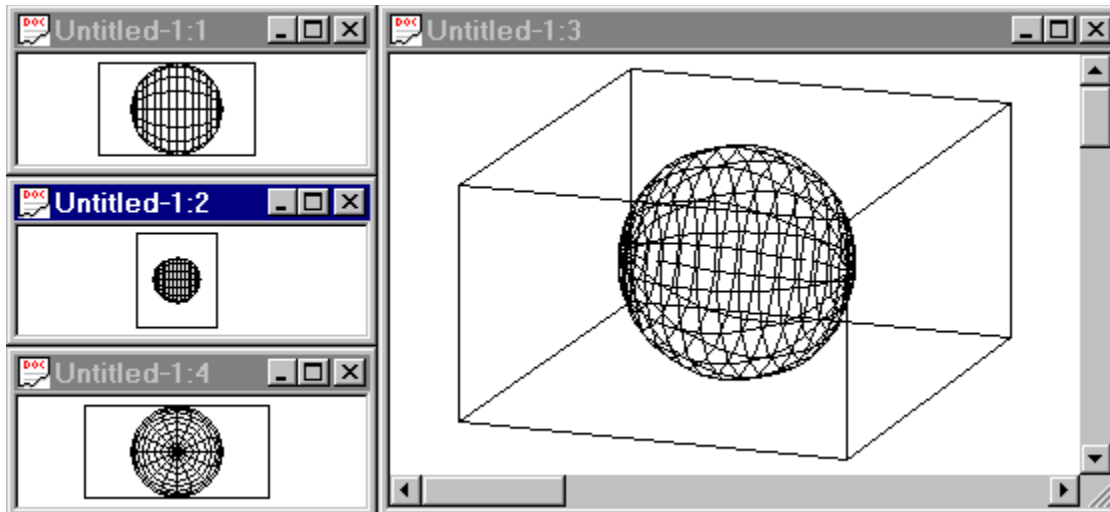

**After**

**See Also: *Fit to Window Command, Zoom In Command, Zoom Out Command***



Menu: OPTIONS

Menu Command: OPTIONS

The General Options folder allows you to control general as well as coordinate and angle options.

### Using the Command

Choose the OPTIONS command, and then click on the GENERAL tab to bring up the General Options folder.

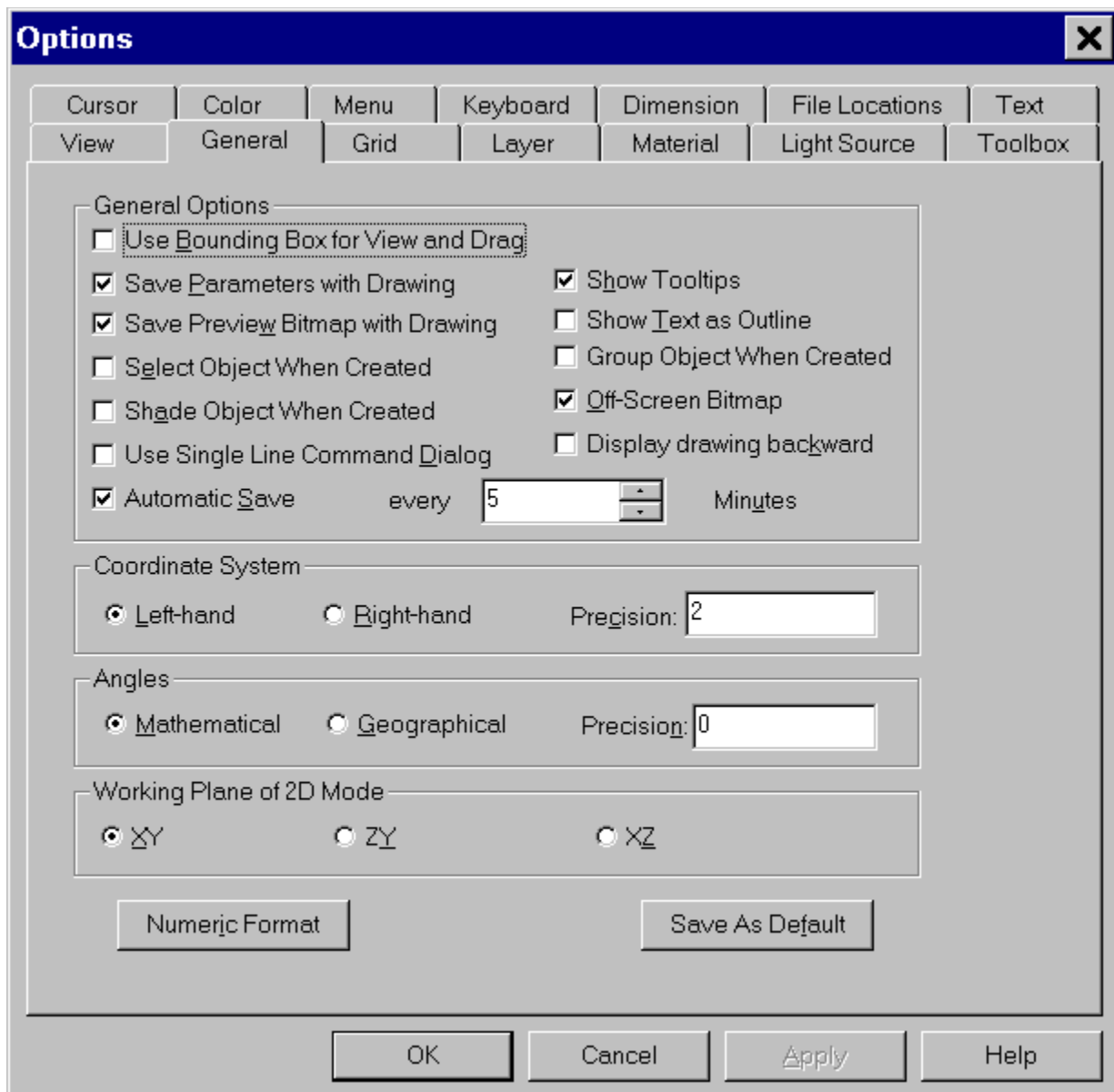

### General Options

Use Bounding Box for View and Drag

- This option determines whether a Bounding Box or a bitmap is displayed when you set the view or drag an object by its selection handle.

#### Save Parameters with Drawing

- This option saves your drawing with the current environment features, such as cursor step size, grid size and display, and other parameters.

#### Save Preview Bitmap with Drawing

- When this option is enabled, a bitmap for the Preview area of the Open dialog box is automatically saved along with the drawing.

#### Select Object When Created

- When this option is enabled, an object is automatically selected when it is drawn.

#### Shade Object When Created

- When this option is enabled, an object is automatically shaded when it is drawn.

#### Use Single Line Command Dialog

- When this option is enabled, options for DesignCAD commands appear in the Command Line (the space directly below the Command Menu that is normally occupied by the Toolbar) instead of command dialog boxes.

#### Show Tooltips

- This option displays a yellow text box beside the cursor when the cursor is placed over a tool in a toolbox.

#### Show Text as Outline

- This option shows just the outline of filled text entities.

#### Group Object When Created

- When this option is enabled objects that are the result of an array, circular array, etc. are automatically grouped when they are drawn.

#### Off-Screen Bitmap

- When this option is active, DesignCAD saves a snapshot of the screen every time you perform certain functions. This option should normally be enabled because it makes the operation of DesignCAD faster.

#### Display Drawing Backward

- When this option is enabled, DesignCAD regenerates objects in the drawing in the reverse order of that in which they were created.

### **Automatic Save**

The Automatic Save Option saves a drawing automatically at intervals defined in the MINUTES box. An Automatic Save stores the open drawing with the name "*filename*(AutoSave).dc." "*Filename*" is the name of the original drawing. The original file ("*filename*.dc") is not modified until the user issues either the Save or Save As command. A Save or Save As updates the "*filename*.dc."

If the file is saved and the program terminates normally, "*filename*.dc" is updated and "*filename*(AutoSave).dc" is removed. If the program crashes, the "*filename*(AutoSave).dc" file won't be removed, so you can open "*filename*(AutoSave).dc" to recover the drawing as it was up to the last Automatic Save.

Also, if you make a mistake and your drawing is "autosaved," you can close the program without saving the drawing file. The "*filename*(AutoSave).dc" file is removed and the "*filename*.dc" is unchanged from the last Save or Save As command.

## Coordinate System

Left-hand

- Choosing this option makes positive direction of the Z axis extend away from you.

Right-hand

- Choosing this option makes positive direction of the Z axis move toward you.

Precision

- Enter the number of digits that you want displayed to the right of the decimal in coordinate measurement.

## Angles

Mathematical

- With MATHEMATICAL angles selected, 0 degrees is the positive X axis (three o'clock) and the degrees progress counterclockwise.

Geographical

- With GEOGRAPHICAL angles selected, 0 degrees is on the positive Y axis (twelve o'clock) and the degrees progress clockwise.

Precision

- Enter the number of digits that you want displayed to the right of the decimal in angular measurement.

## Working Plane of 2-D Mode

Click to select the workplane DesignCAD will display when in 2-D Mode.

## Numeric Format

Click this button to open the Numeric Format dialog box. This dialog box contains options that control the format of coordinate and angular values displayed in the Coordinate Bar.

Coordinate Format

- decimal
- fractional
- engineering
- architectural

Angle Format

- degrees
- grads
- radians
- degrees, minutes, seconds

## Save As Default Option

If you want to save the changes to the next session, click the SAVE AS DEFAULT button. Click OK

when you are finished.

Menu: POINT  
Menu Command: GRAVITY  
Shortcut Key: . (period)  
Mouse Shortcut: Right Mouse Button

Toolbox Icon: 

This very useful command moves the cursor to the nearest point in the drawing and sets a point there. It allows you to set a point exactly on another point without having to "zero in" on it.

### Using the Command

When you choose the command and you're in 3-D Selection Mode, the cursor moves to the nearest point in 3-D space. In 2-D Selection Mode, the cursor moves to the nearest point on the screen and does not take into account the point's location in 3-D space.

This is an important difference. If you want to be able to snap to the nearest point on the screen, you should use the 2-D Selection Mode. However, in 2-D Selection Mode, the cursor may seem to move in an arbitrary manner along the Z axis when you snap to a point because the cursor takes on the Z value of the point that it snaps to.

In 3-D Selection Mode, the cursor may seem to jump to a point other than the nearest point on the screen. This is because it goes to the nearest point in the drawing, in three-dimensional space. That point may not be the point that appears nearest on the screen.

### Example: Set a point exactly on the right endpoint of a line.

Select the GRAVITY command. Move the cursor to a point near the right end of the line. Click the mouse button. The cursor snaps to the right endpoint and sets a point.

Menu: POINTS  
Menu Command: GRAVITY MOVE  
Shortcut Key: , (comma)

Toolbox Icon: 

The Gravity Move command snaps the cursor to the nearest point in the drawing, but it does *not* set a point there.

### Using the Command

The Gravity Move command lets you move the cursor to another point precisely without having to "zero in" on it. As soon as you choose the command, the cursor snaps to the nearest point in the drawing without setting a point.

Gravity Move is often convenient for moving the cursor to a point in the drawing to get to a known location before using the cursor keys or the Point Relative command.

In 3-D Selection Mode, the cursor moves to the nearest point in 3-D space. In 2-D Selection Mode, the cursor moves to the nearest point on the screen and doesn't take into account the point's location in 3-D space.

This is an important difference. If you want to be able to snap to the nearest point on the screen, you should use the 2-D Selection Mode. However, in 2-D Selection Mode, the cursor may seem to move in an arbitrary manner along the Z axis when you snap to a point because the cursor takes on the Z value of the point that is snapped to.

In 3-D Selection Mode, the cursor may seem to jump to a point other than the nearest point on the screen. This is because it goes to the nearest point in the drawing, in three-dimensional space. That point may not be the point that appears nearest on the screen.

Menu: OPTIONS  
Menu Command: GRID SETTINGS  
Shortcut Key: **Ctrl+G**

The Grid Settings command opens the Grid Options folder of the Options file box. In this folder you can set the options for the Display and Snap grids.

### **Using the Command**

Choose the GRID SETTINGS command. The Grid Options folder appears. Set the options to meet your drawing needs. (See "Grid Options" for details.)

Menu: OPTIONS  
Menu Command: OPTIONS  
Shortcut Key: Q

The Grid Options folder lets you set Snap and Display grid preferences.

### Using the Command

Choose the OPTIONS command, and then click on the GRID tab to bring up the GRID OPTIONS folder.

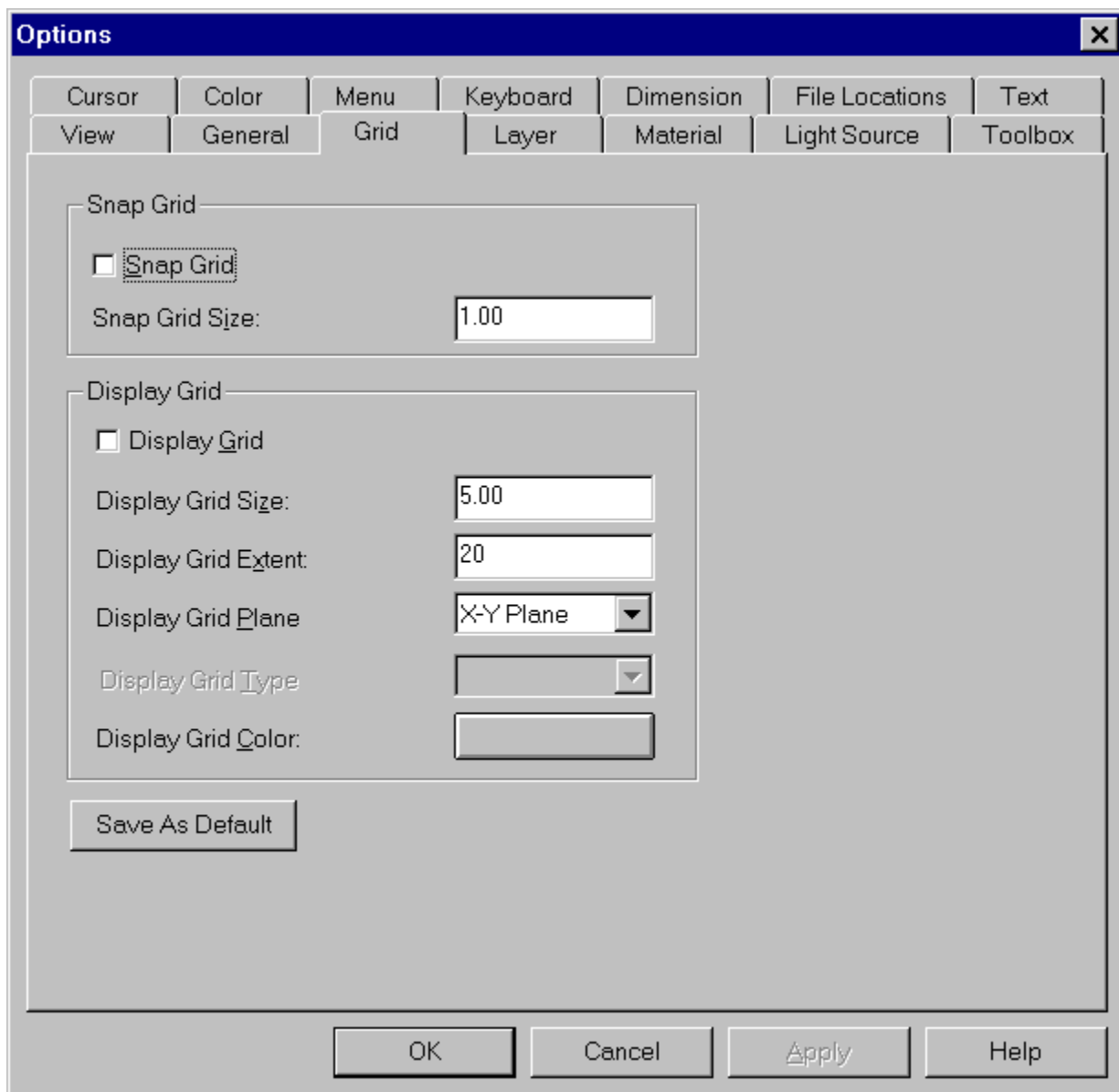

### Snap Grid

Snap Grid



- Choosing this option forces the cursor to the nearest point on an invisible grid each time you set a point in the drawing.

#### Snap Grid Size

- The size of the snap grid, in Drawing Units, can be set by clicking on the Snap Grid Size text box.

### **Display Grid**

#### Display Grid

- Clicking this checkbox forms a *visible* grid on the drawing screen.

#### Display Grid Size

- Enter the number of Drawing Units desired for the height and width of each Grid Unit.

#### Display Grid Extent

- Enter the number of Grid Units you want along the axes in each quadrant. This option is only has an affect if DesignCAD is in 3-D Mode. In 2-D Mode the Display Grid will always extend to the edges of the drawing area.

#### Display Grid Plane

- Choose the plane in which you want the grid to lie, by clicking on the down arrow beside the text box and then clicking on the desired option. This option is only available in 3-D Mode. In 2-D Mode the plane for the Display Grid will always be the X-Y plane.

#### Display Grid Type

- Choose the line type for the grid, by clicking on the down arrow and selecting it from the list box. This option is only available in 2-D Mode.

#### Display Grid Color

- Selecting this option brings up the color palette. Choose which color you want the grid to be by clicking on that color in the palette.

Menu: TOOLS  
Menu Command: GROUP DEFINE

The Group Define command puts all of the currently selected drawing entities into one group. The next time you select any part of the group, the entire group is selected. You can have many different groups defined in a drawing. Group Define makes it easy to keep related items together for copying, moving, scaling, and other operations.

### **Using the Command**

Select all the objects you want to include in a group. When they are selected, choose the GROUP DEFINE command. DesignCAD treats the objects as a group and continues that way until the objects are ungrouped with the Group Explode command.

### **Example: Convert several objects into a single object.**

Select the objects you want to redefine. Choose the GROUP DEFINE command. All of the objects will be recognized by DesignCAD as a single group.

***See Also: Group Explode Command***

Menu: TOOLS  
Menu Command: GROUP EXPLODE

The Group Explode command dissolves the currently selected group so that its members become single entities and can again be selected individually. Drawing entities are not affected except that they lose their association with the group.

### **Using the Command**

With the group selected, choose the GROUP EXPLODE command. The only way to restore group status for the objects is to select all of the members again and use Group Define. Undo does not cancel the effect of Group Explode. To restore group status, select all of the members again and use the Group Define command.

### **Example: Break up a group of objects into individual entities.**

Select the group and choose the GROUP EXPLODE command. The group is redefined and the objects can be manipulated individually.

***See Also: Group Define Command***

Menu: EDIT

Menu Command: HAMMER

Point 1: Source point on the grid (point where the hammer hits)

Point 2: Destination point (where the hammer forces the grid)

The Hammer command can be used to reshape a surface grid.

### Using the Command

Choose the Hammer command. In the Command Line choose the options you want. You can specify the size of the area affected by this command can be specified by entering the radius in the RADIUS box in the Command Line. You can also select whether the modified portion of the surface is to have a rounded or sharp point.

When you have specified the options you want, set a point on the surface grid at the location it is to be modified, and a point for the destination of that location. The surface is "hammered."



The Hammer command only moves existing points (intersections) on the grid. It does not create any new points. When you construct a grid to be modified with the Hammer command, you should make the spacing dense enough to get a smooth result.

**Note:** The Hammer command only affects grids. It does not affect planes, lines, curves, arcs, or extruded objects. It can be useful in creating specially shaped surfaces.

### Example: Reshape a flat grid surface.

Choose the HAMMER command. Enter **20** in the RADIUS field and click the ROUNDED radio button. Set a point on the center of the grid. Move the cursor outward from the center of the grid and set the second point. The grid will have a rounded impression in it.

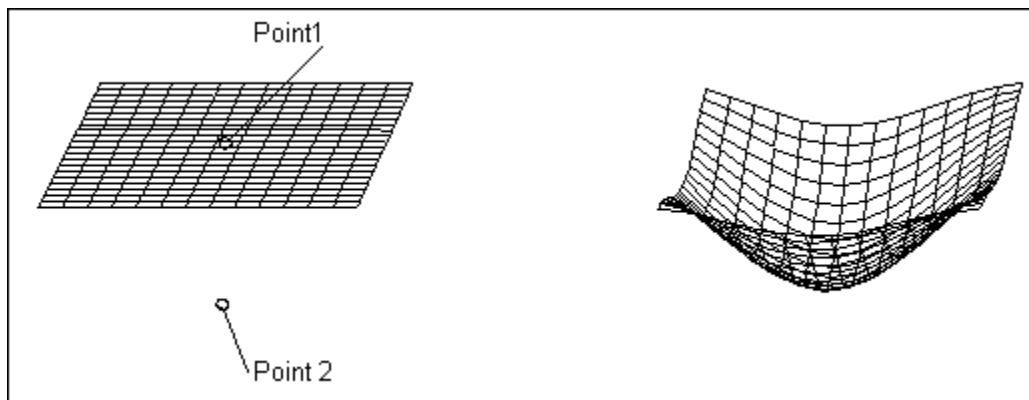

Menu: DRAW  
Submenu: HATCH  
Menu Command: HATCH  
Shortcut Key: #  
Points 1-n: Outline of area to be hatched

The Hatch command fills an area with a hatch pattern. Points are set around the outside of the area to be hatched.

### Using the Command

Choose the HATCH command from HATCH submenu in the DRAW menu.

Enter the size of the hatch pattern in the HATCH SCALE box in the Command Line. Enter the angle of the hatch pattern in the HATCH ANGLE box. Next, click the HATCH PATTERN button to choose the hatch pattern. To have the hatch pattern drawn with the same options as another hatch pattern in the drawing, click the SAME AS button. Then set a point on the hatch pattern in the drawing.

Set points around the area to be hatched. Click the mouse or press **Enter**. The area is filled with the hatch pattern.

**Note:** The Hatch commands are only available if the program is in 2-D Mode. The Hatch patterns will not be displayed if the program is taken out of 2-D Mode, but the hatched areas will continue to be defined as such. This means that you can view and print the hatched areas by reentering 2-D Mode.

**Note:** The lines making up hatch patterns are defined as a single entity. These lines can be edited or erased only as an entity.

---

#### Scale and Angle

The scale and angle of the hatch patterns can be changed in the Command Line boxes. The scale is the size of the pattern elements. The angle is the angle at which the pattern is drawn.

#### Changing the Hatch Pattern

Click on the HATCH PATTERN button. The Hatch Pattern box appears. Click on the pattern style you want, then click the OK button or press **Enter**.

#### **Example: Draw an object filled with a brick pattern.**

Select the HATCH command from the HATCH submenu of the DRAW menu. In the Command Line, set the HATCH SCALE, the HATCH ANGLE, and the HATCH FILL pattern. Return to the drawing.

Choose the ORTHO LINE command and draw the object. Then press **Enter** to end the drawing command. The box is filled with the brick pattern.

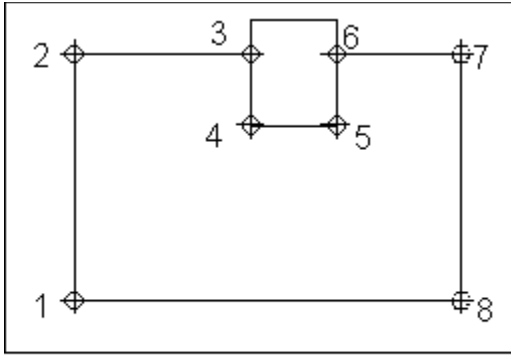

Before

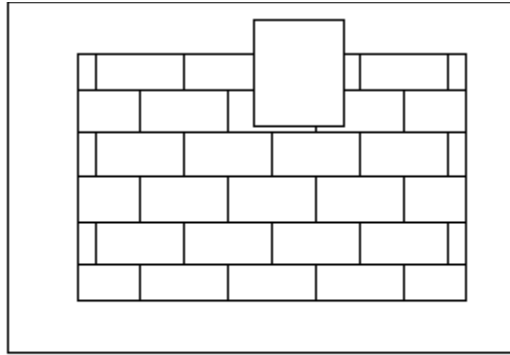

After

**See Also: *Hatch Fill Command, Hatch Line Command***

Menu: DRAW  
Submenu: HATCH  
Menu Command: HATCH FILL  
Point 1: In the area to be hatched

The Hatch Fill command fills an area enclosed by lines with the specified hatch pattern.

### **Using the Command**

Choose HATCH FILL from the HATCH submenu of the DRAW menu. Enter the size of the hatch pattern in the HATCH SCALE box in the Command Line. Enter the angle of the hatch pattern in the HATCH ANGLE. Click the HATCH PATTERN button to choose a hatch pattern.

If the entity is selected before the command is chosen, click the SELECTION ONLY box to limit the hatch boundary to only those lines that are selected.

Next, set a point inside the area to be hatched. The area is filled automatically with the hatch pattern.

**Note:** The Hatch commands are only available if the program is in 2-D Mode. The Hatch patterns will not be displayed if the program is taken out of 2-D Mode, but the hatched areas will continue to be defined as such. This means that you can view and print the hatched areas by reentering 2-D Mode.

---

**See Also:** *Hatch Command, Hatch Line Command*

Menu: DRAW  
Submenu: HATCH  
Menu Command: HATCH LINE  
Point 1: On the enclosed line to be hatched

The Hatch Line command fills the area of an enclosed line with a hatch pattern. First, the hatch pattern is selected, and then points are set on the line or lines to be hatched.

### Using the Command

Choose the HATCH LINE command from the HATCH submenu of the DRAW menu. Enter the size of the hatch pattern in the HATCH SCALE box in the Command Line. Enter the angle of the hatch pattern in the HATCH ANGLE box. Click the HATCH PATTERN button to choose the hatch pattern.

Next, select the line or lines to be hatched. Click the mouse or press **Enter**. The area inside the enclosed line is filled with the hatch pattern.

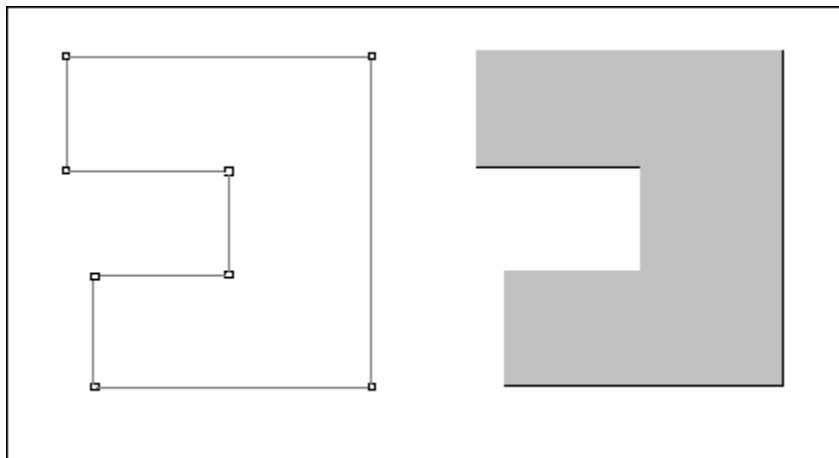

**Note:** The Hatch commands are only available if the program is in 2-D Mode. The Hatch patterns will not be displayed if the program is taken out of this Mode, but the hatched areas will continue to be defined as such. This means you can view and print the hatched areas by reentering 2-D Mode.

**See Also:** *Hatch Command, Hatch Fill Command*



Menu: SOLIDS  
Menu Command: HEMISPHERE

Toolbox Icon: 

Point 1: Center of the flat face  
Point 2: Radius of the flat face  
Point 3: Direction of the dome

The Hemisphere command draws solid hemisphere.

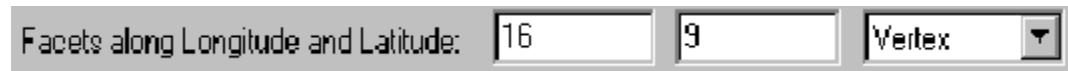

### Using the Command

Choose the HEMISPHERE command. Enter in the NO. OF FACES boxes in the Command Line the number of sides you want the hemisphere to have around its edge and from “equator” to “pole”. You may also choose whether the second point represents a point at a vertex of the rim, or a midpoint of one of the flats on the rim.

When you draw the hemisphere, you may find it helpful to think of the object as a covered bowl. Point 1 is set for the center of the cover. Point 2 is somewhere on the rim. Point 3 defines the direction of the bottom of the bowl from Point 1.

### Example: Add a hemisphere to your drawing.

Select the HEMISPHERE command and set a point for the center of the flat face. Move the cursor away from the first point. A rubber-band hemisphere will be drawn to represent the hemisphere using the cursor location as the second point. When the hemisphere is the desired radius, set the second point. Move the cursor to position the dome and set the third point.

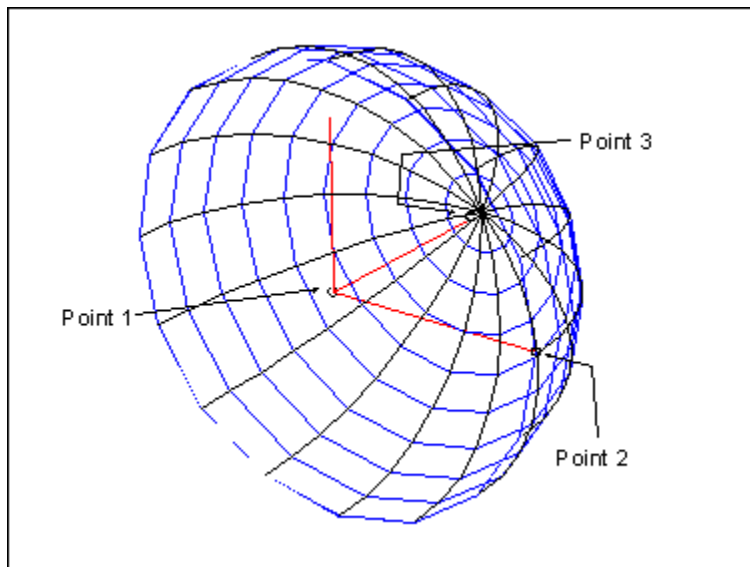

Menu: TOOLS  
Menu Command: HIDDEN LINE REMOVAL  
Shortcut Key: CTRL+F8

Toolbox Icon: 

The Hidden Line Removal command performs hidden line removal on the entire drawing or on a section of the drawing. This causes all lines behind surfaces to be removed, giving the objects a more realistic image.

### Using the Command

Choose the HIDDEN LINE REMOVAL command. Specify whether you want to remove lines for the entire drawing or only a section. If you choose the Section option, a rubber-band box appears. Set two points to enclose the section on which you want DesignCAD to execute the Hidden Line Removal command.

You can also specify whether you want the text and dimensions to be displayed with the resulting image.

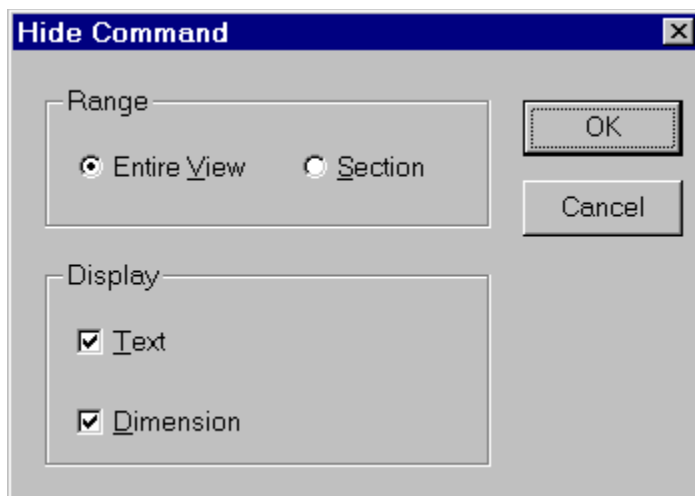

**Example: Get a clear view of several objects arranged in front of and behind one another.**

Select the HIDDEN LINE REMOVAL command. Choose the ENTIRE VIEW button and click OK. After the view has been redrawn, notice how much easier it is to see the orientation of the objects.

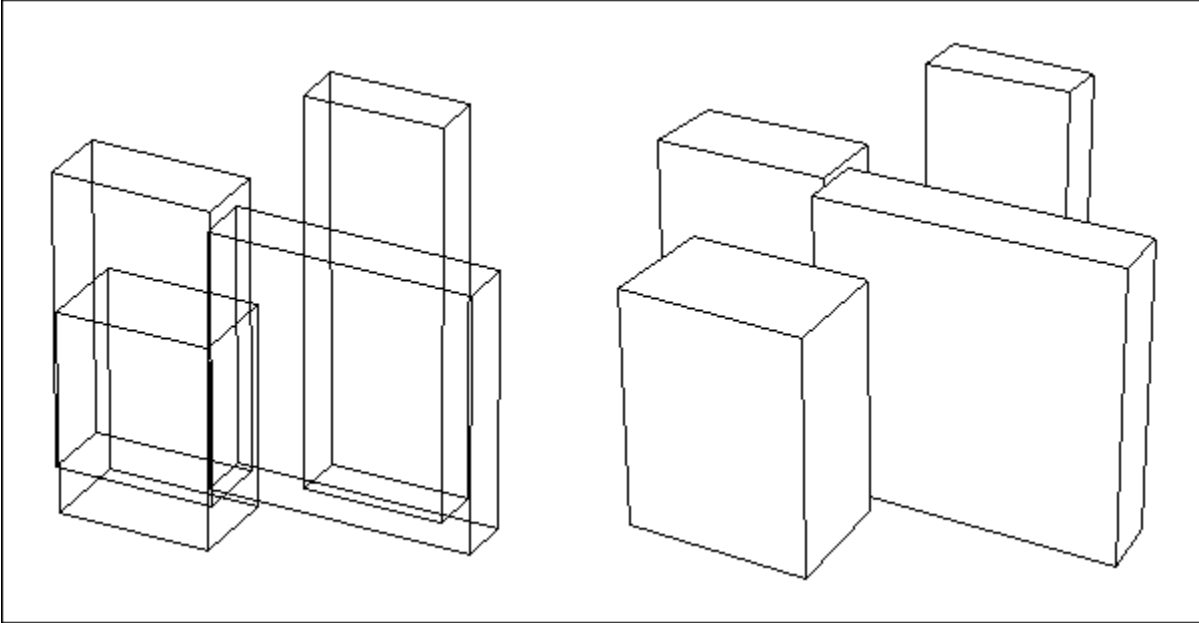

Menu: FILE  
Submenu: IMPORT  
Menu Command: *IMPORTformat*

The Import command lets you import files in several formats.

### Using the Command

Choose the format type in the FILE|IMPORT submenu. The IMPORT box appears. In the FILE NAME box enter the name of the file to import. In the LOOK IN box, tell the program where the drawing to import is stored. When you have entered the information, choose the **Open** button to import the drawing. Choose the CANCEL button to return to the current drawing without importing a file.

DesignCAD 97 for Windows 95 imports the following file formats:

#### DWG

DesignCAD imports AutoCAD's DWG format directly.

#### DXF

DXF files can be used with many other Windows applications.

#### HPGL

HPGL is the Hewlett Packard graphics language. You can configure other applications for an HP plotter, send the plotter output to disk, and import that file into DesignCAD 97.

#### IGES

The IGES format is a standard format that many CAD systems support. DesignCAD 97 supports the following IGES entities for input:

100	Circular Arc
102	Composite Curve
104	Conic Arc
106	Copious Data
108	Plane
110	Line
112	Parametric Spline Curve
114	Parametric Spline Surface
118	Ruled Surface
120	Surface Revolution
122	Tabular Cylinder
124	Transformation Matrix
212	General Note
214	Arrow
318	Define Subfigure
408	Insert Subfigure

### Metafile

Many Windows applications can read Windows Metafiles, and the Import command allows you to bring those files into DesignCAD.

### Text

DesignCAD 97 lets you import text files into your drawing. If the text file contains many DOS extended characters, it might be a good idea to change them in a text editor before importing the file. Windows may not recognize the extended characters.

### XYZ (or XY)

DesignCAD 97 can import text files containing X,Y or X,Y,Z coordinates. The following conditions apply to the Import XYZ command:

1. The coordinates for each point should be on one line. They must be separated by either a space, a comma, a semi-colon, or a tab.
2. Individual line or curve entities must be separated by at least one empty line in the text file.
3. Any line which starts with a semi-colon is treated as a comment.
4. Comments may appear anywhere in the file.

You can connect the points with straight lines or smooth curves, or you can mark their position with a plus sign or small circle. If you choose to mark the points, you can set the size of the mark or circle in the edit box. The size is set in Drawing Units.

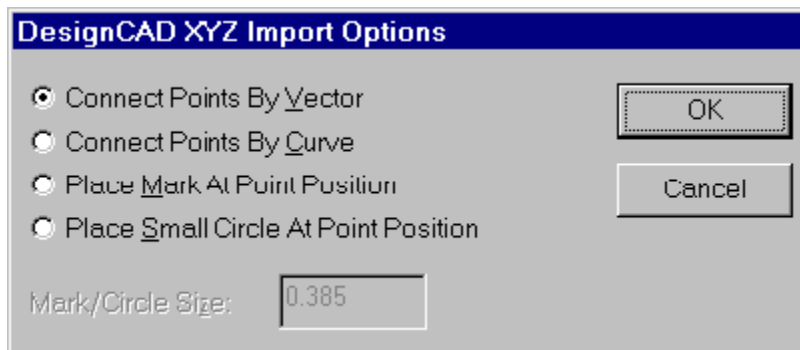

### Example: Import an HPGL file.

Choose the IMPORT HPGL command. The IMPORT box appears. Choose a path and file name for the file and click OK. The drawing is converted from HPGL file format and imported into DesignCAD.

Menu: VIEW  
Menu Command: INFO BOX  
Shortcut Key: **Ctrl+I**

The Info Box command can be used to view and edit properties of a selected object. To activate the command, you must select an object *before* executing the command.

## Using the Command

Select an object and choose the INFO BOX command.

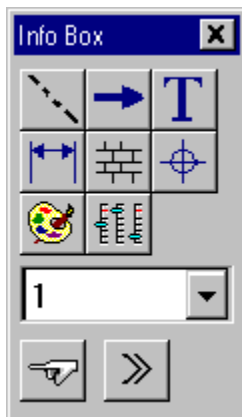

The available items in the Info Box vary depending on the type of object you have selected.

All Info Boxes contain Layer, Color, and Material information.



Click the  button to display details on the selected object like point locations, scale, etc.

Here are six of the most common kinds of Info Box configurations which are based on object categories. Each contains information relevant to the specific category of object.

### Plane

- Current Point: the number of the point to which the information applies.
- Next/Previous: information for the next or previous point in the entity.
- X,Y,Z: the coordinate of the current point on each axis.
- Length: The measurement of the perimeter in Drawing Units.
- Area: The area measurement of the plane in Drawing Units.
- Smooth – True: Smooth enabled; False = Smooth Disabled.

### Circle/Arc

- Center X, Y, Z: The coordinate of the center on each axis.
- Radius: the radius in Drawing Units.
- Start Angle: the starting angle of the Circle/Arc.
- Span Angle: the span angle of the Circle/Arc.
- Length: the circumference of the circle or length of the arc in Drawing Units.

## Dimension

- Text Font: the typeface of the text.
- Text Size: the point size of the text.
- Accuracy: the number of digits after the decimal point in the dimension.
- Arrow Type: the type of arrow used in the dimension.
- Format: the format of the dimension text.
- Reverse Text Direction: reverses the direction of dimension text.

## Curve

- Current Point: the number of the point to which the information applies.
- Next/Previous: the information for the next or previous point in the entity.
- X,Y,Z: the coordinate of the current point on each axis.
- Length: the measurement of the curve in Drawing Units.

## Text

- Content: the letters, numbers, and symbols that make up the text entry.
- Font: the typeface of the text.
- Length: the length of the text entity in Drawing Units.
- Height: the height of the text entity in Drawing Units.
- Angle: the angle at which the text entity is placed in the drawing.

## Solid

- X,Y,Z Scale: the scale of the solid along each axis.
- Smooth True: Smooth Enabled; False = Smooth Disabled.
- Smooth: Enables or disables the smooth shade option.

The Smooth shade option is selected by default for all solids. This causes curved surfaces to appear smooth, with their faceted edges rounded off. Smooth shading can be disabled in order to force the facets of the shaded solid to be visible.

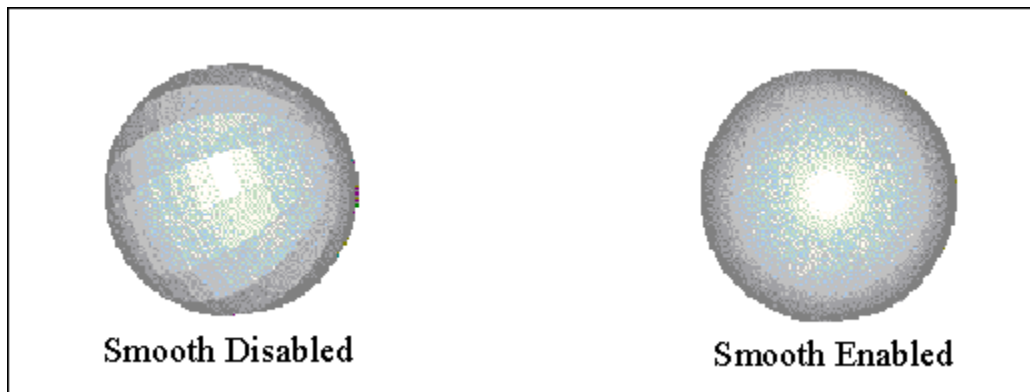

Menu: SOLID  
Menu Command: INTERFERENCE CHECK  
Point 1: First solid to check for interference  
Point 2: Second solid to check for interference

The Interference Check command checks two solids to see if they overlap one another at any point. To use this command, select the command and set a point on each solid. DesignCAD will display a dialog box stating whether or not interference is detected.

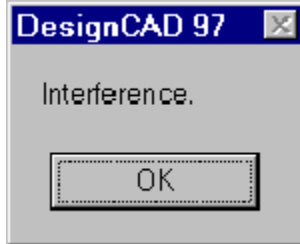
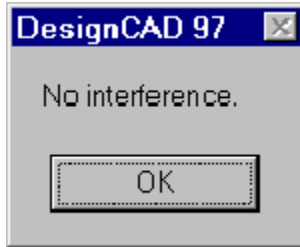

**Example:** Check if two solids intersect. Select the INTERFERENCE CHECK command. Set one point on the first object and another on the second. DesignCAD will display the interference status. Click OK to remove the box from the screen.



Menu: POINT  
Menu Command: INTERSECT-1

Toolbox Icon: 

Point 1: Line on which you want to find an intersection

The Intersect-1 command finds the nearest intersection to a point.

### **Using the Command**

Set a point on the line on which you want to find the intersection. The cursor will move to the nearest intersection on that line and a point will be set there.

This command works on lines, circles, arcs, planes, and curves.

### **Example: Find the intersection of a line and a circle.**

Select the INTERSECT-1 command. Set the cursor on the line and click the left mouse button. The cursor will move to the intersection of the line and the circle, and a point will be set there.

Menu: POINT  
Menu Command: INTERSECT-2

Toolbox Icon: 

Point 1: First line of intersection  
Point 2: Second line of intersection

The Intersect-2 command locates the intersection of two entities, using two points as references.

### **Using the Command**

Set a point on each entity. The cursor will move to their point of intersection.

This command works on lines, circles, arcs, planes, and curves.

**Note:** If the lines do not meet, then the cursor will move to a point where they would meet.

---

### **Example: Find where two lines intersect in a "web" of intersecting lines.**

Choose the INTERSECT-2 command and set a point on one of the lines. Next set a point on one of the intersecting lines. The cursor will move to the intersection of the two lines.

Menu: EDIT  
Menu Command: JOIN ENDPOINTS  
Point 1: First corner of area to be joined  
Point 2: Second corner of area to be joined

The Join command takes all of the points enclosed within a bounding box and moves them to a single point at their geometric center.

### Using the Command

Choose the JOIN command. Drag a box around the endpoints of the lines to be joined. Do not completely enclose all the lines or they will be reduced to a single, tiny point. The bounding box should enclose only the endpoints of the lines you want to join, not the lines themselves.

You can join only on certain lines by selecting those lines before executing the command. If some lines are selected, then only those selected lines will be joined. This makes it easy to join specific lines in a "busy" drawing.

### Example: Join lines that do not meet at their endpoints.

Select the JOIN ENDPOINTS command. Set a point for one of the corners of the bounding box and move the cursor so that the rubber-band bounding box encloses all of the endpoints that you want joined. When you have done this, set the second point. The lines will be redrawn with their endpoints moved to the geometric center of the bounding box.

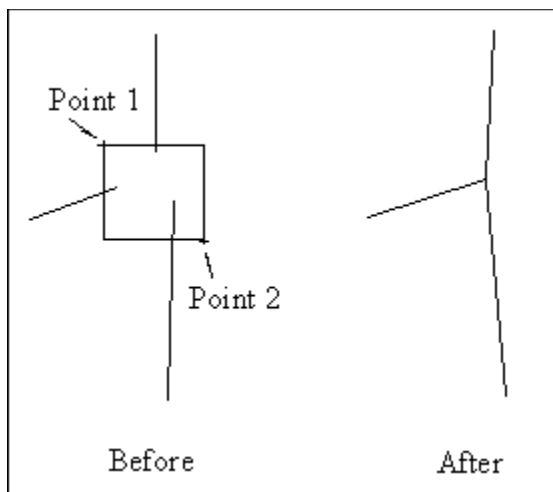

Menu: TOOLS  
Submenu: CUSTOMIZE  
Menu Command: KEYBOARD

The Keyboard command is a shortcut method of bringing up the Keyboard Options folder of the Options file box.

### **Using the Command**

Choose the KEYBOARD command from the CUSTOMIZE submenu in the TOOLS menu. The Options file box is displayed with the Keyboard Options folder showing. For a complete listing of the options available in this folder, see the "Keyboard Options" entry in the "Command Reference" section of this manual.

***See Also: Keyboard Options***

Menu: OPTIONS  
Menu Command: OPTIONS

The Keyboard Options folder lets you assign or change a shortcut key to any menu command, executable file or other application.

Shortcut keys let you go directly to a command from the keyboard. You can also use them to start an executable file — such as a Visual Basic program or another DesignCAD application — from within DesignCAD.

## Using the Command

Choose the OPTIONS command from the OPTIONS menu. Click the KEYBOARD tab to make the Keyboard Options folder visible.

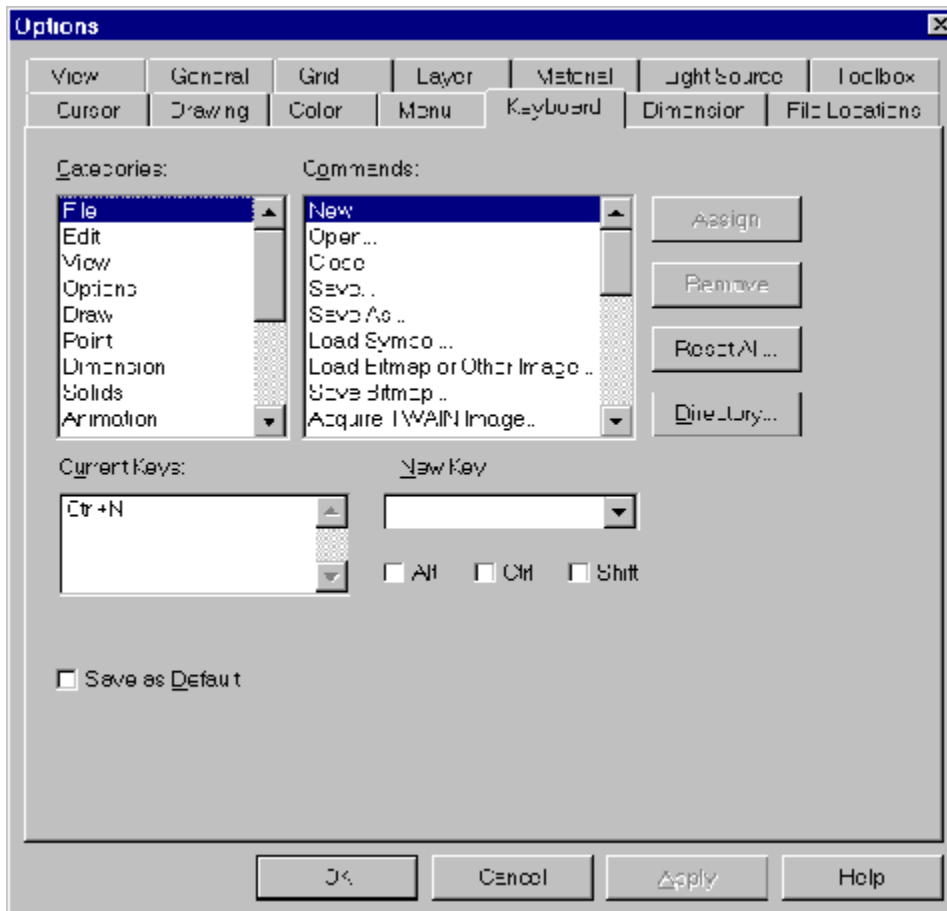

To find the command you're making a shortcut for, click the appropriate menu command in the CATEGORIES box. These correspond to the commands on the Main Menu.

**Note:** If you assign shortcut keys to applications in Windows 95, they may take precedence over the assignments in DesignCAD.

When a main menu command is selected in CATEGORIES, commands on its corresponding pull-down menu will appear in the COMMANDS box. Click a command name. If it has a shortcut

assigned, the keys will appear in the CURRENT KEYS box.

To change or create a shortcut, click in the NEW KEY box, scroll through the keys list and click a key you want to assign. Check the ALT, CTRL or SHIFT box to select which function key you want to use with the other key. The new shortcut combination is now listed to the right of the New Key statement.

Click ASSIGN to finish making the shortcut, and the new shortcut appears in the CURRENT KEYS box. Repeat the steps if you want to create other shortcuts. If the customization task is complete, click OK.

To remove a shortcut key you've made, select the command you want to change, click on the shortcut in the CURRENT KEYS box, then click REMOVE. You can remove all shortcuts and return to default settings by clicking RESET ALL.

### **Example: Make a File Shortcut**

Choose the OPTIONS command from the OPTIONS menu. Click the KEYBOARD tab. Scroll through the CATEGORIES box and click the desired file type. Select the drive and directory that contains the file to which you want to assign a keyboard shortcut. A list of files in that category and location appears in the FILES box. Click to select the desired executable file.

Click in the NEW KEY box, scroll through the keys list and click the key you want to assign. Check the ALT, CTRL or SHIFT box to select which function key you want to use with the other key. The new shortcut combination is now listed to the right of the NEW KEY statement.

Click ASSIGN to finish making the shortcut and the new shortcut appears in the CURRENT KEYS box. Repeat the steps to create other shortcuts. When you are finished, click OK.

### **See Also: Options Command**

Menu:                    OPTIONS  
Menu Command:        LAYER  
Shortcut Key:           **L**

The Layer command brings up the Layer Options folder, where you can enable or disable layers, name layers, select layers, and perform other functions.

### **Using the Command**

Choose the LAYER command. The LAYER OPTIONS folder appears. Choose the settings you prefer and click the OK button. Press CANCEL to return to the drawing without keeping any changes.

***See Also: Layer Options***

Menu: OPTIONS  
Menu Command: OPTIONS  
Shortcut Key: Q

The Layer Options folder allows you to enable or disable layers, name layers, select layers, and perform other functions.

## Using the Command

Choose the OPTIONS command from the OPTIONS menu and click on the LAYER tab. The LAYER OPTIONS folder appears. Choose the settings you prefer and click the OK button. Press CANCEL to return to the drawing without keeping any changes.

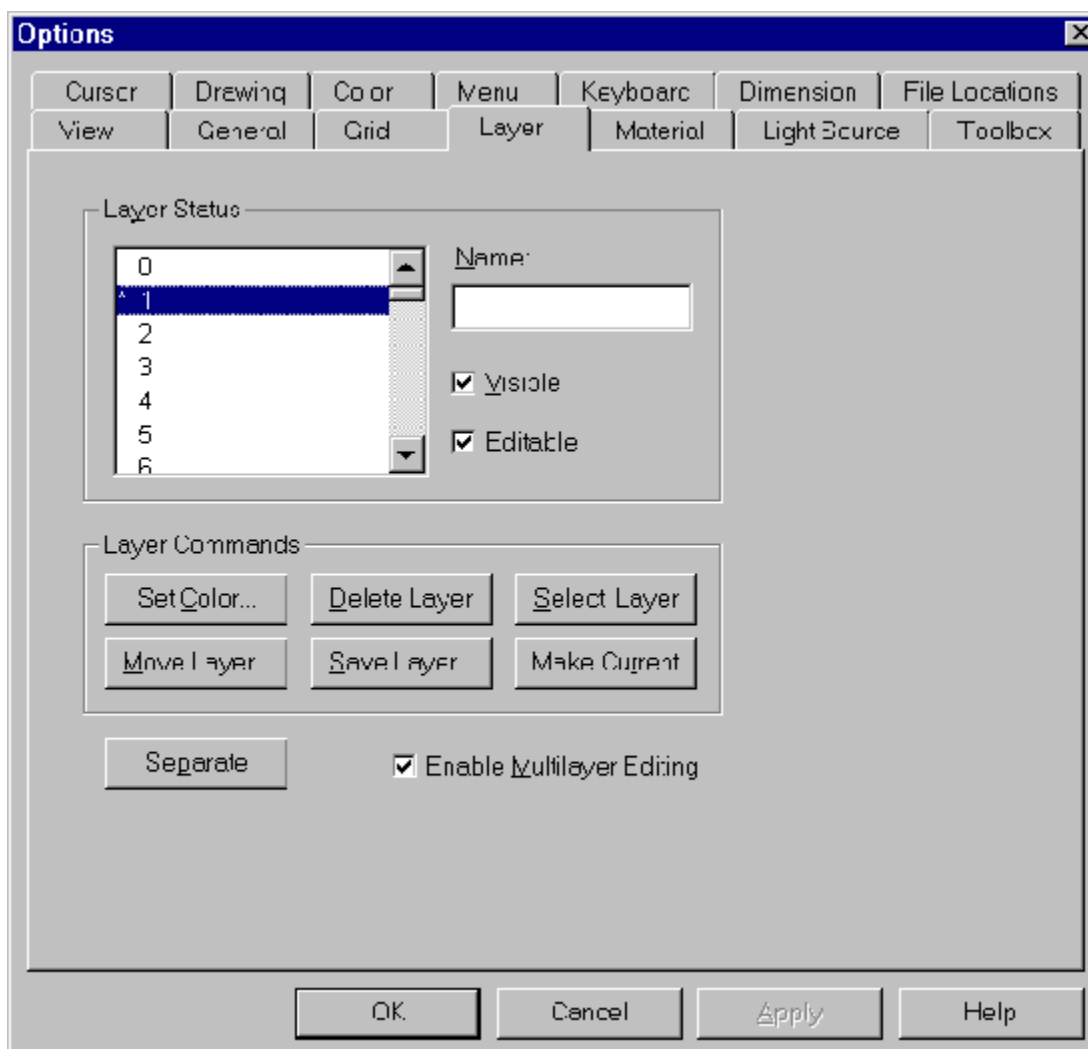

## Layer Status

Name

- You can assign names to the different layers in the drawing. To do this, highlight the layer number at the left and enter its new name in the NAME field.



### Editable

- This option determines whether or not the objects in the highlighted layer may be edited. If a layer is not editable, it means that even though you can see the objects in the layer, you cannot modify them.

### Visible

- You can hide layers by making them invisible. This is convenient when you need to reduce the "clutter" in a large drawing.

For example, you could hide all the electrical wiring in a house plan when you add the dimensions, or remove the text from a schematic when you add components.

## **Layer Commands**

### Set Color

- Assigns a color for all objects in a layer. All existing objects in the layer will be changed to the chosen color after the command is completed.

### Delete Layer

- This erases all entities in the highlighted layer.

### Select Layer

- This selects all objects in the highlighted layer.

### Move Layer

- This moves contents of one layer to another.

### Save Layer

- This option saves the contents of an individual layer as a separate file.

### Make Current

- This options sets the selected layer as the active layer for the drawing.

### Separate

- This option sorts objects into layers by color. All objects of the same color will be put into the same layer, regardless of their previous layer.

### Enable Multilayer Editing

- This option allows you, from the drawing screen, to manipulate all visible objects in editable layers. If this option is disabled, you can only manipulate objects in the active layer. This option makes all layers except the current layer uneditable.

Menu: TOOLS  
Menu Command: LIGHT SOURCE

The Light Source command brings up the Light Source Options folder, which gives you the option of setting up as many as eight different light sources. Each source is activated by clicking the checkbox beside it.

### **Using the Command**

Choose the LIGHT SOURCE command. The Options file box is displayed with the Light Source Options folder showing. For a complete list of the options available in this folder, see Light Source Options.

***See Also: Light Source Options***

Menu: OPTIONS  
Menu Command: OPTIONS

The Light Source Options folder lets you set up as many as eight different light sources. Each source is activated by clicking the checkbox beside it.

### Using the Command

Choose the LIGHT SOURCE command. Set the INTENSITY, HORIZONTAL ANGLE, and VERTICAL ANGLE. Then click the OK button.

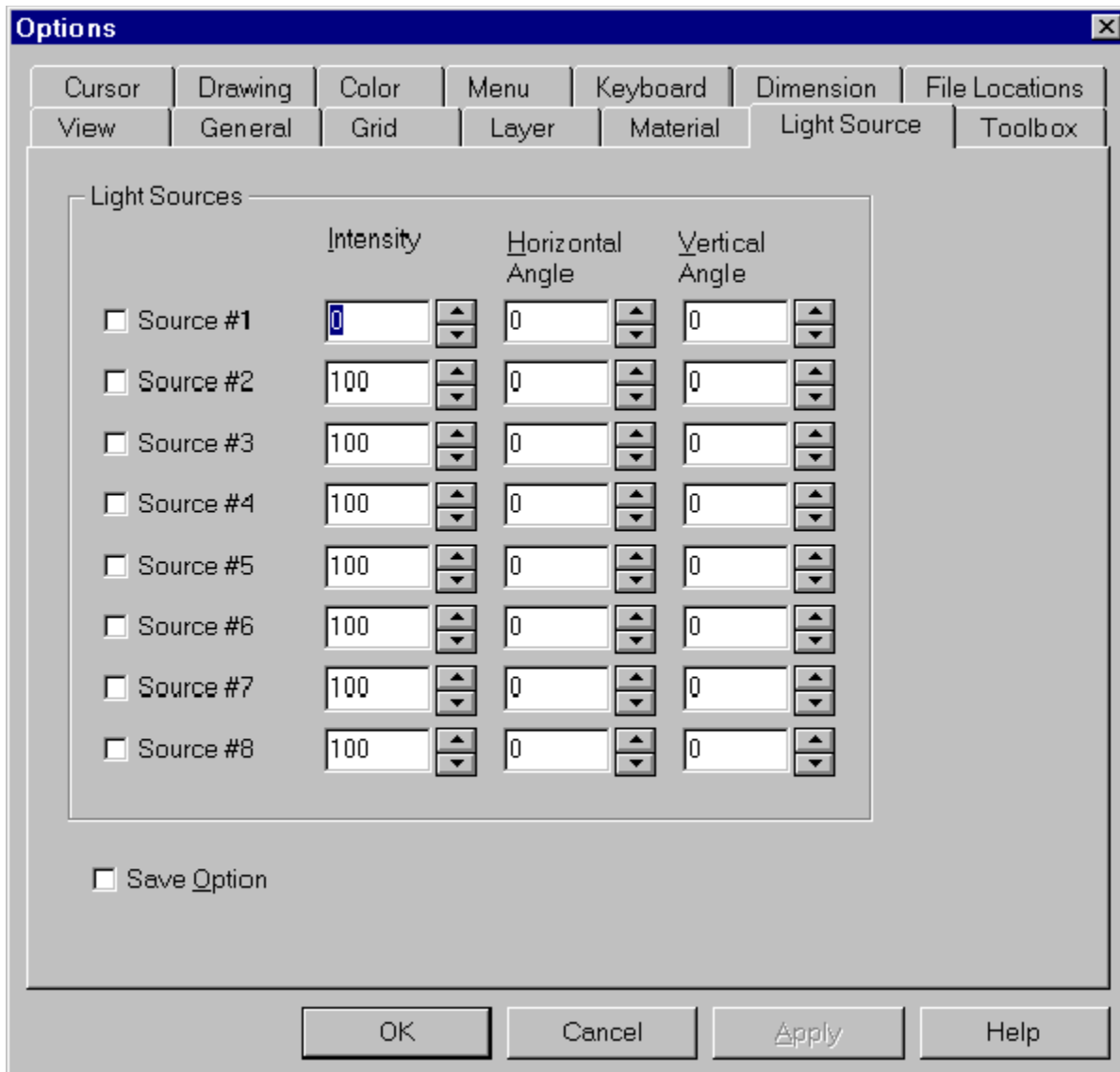

### Light Sources

#### Intensity

- You can specify the intensity of each light source. Increasing the intensity of one light source does not increase the total amount of light. The total light is divided between each

of the active light sources. If all eight light sources are turned on and set to intensity 100, each contributes 1/8 of the total light.

#### Horizontal Angle

- This option can be used to set the horizontal angle of the light source relative to the drawn object.

#### Vertical Angle

- This can be used to set the vertical angle of the light source relative to the drawn object.

#### **Example: Draw a sphere and smooth shade it.**

Notice how the light reflects off of the object. Next, select the LIGHT SOURCE command. Set the VERTICAL ANGLE to **60** and the HORIZONTAL ANGLE to **45**. For this example, leave the other settings at their defaults, but be aware that you can change them to suit your preferences. Click OK. Now, reshade the sphere and notice the changes in appearance.

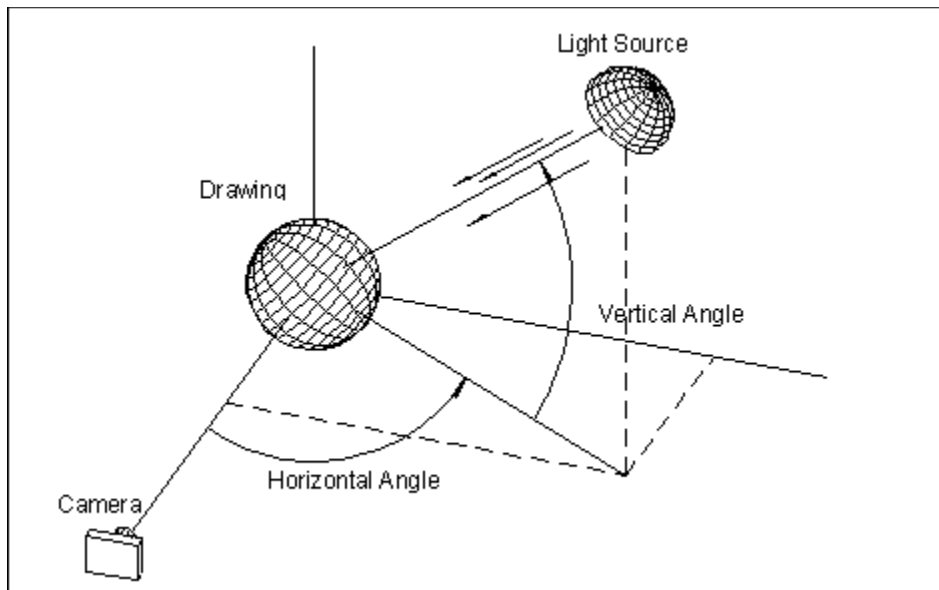

Menu: DRAW  
Submenu: LINES  
Menu Command: LINE  
Shortcut Key: **V**

Toolbox Icon: 

Point 1-n: Points through which the line passes.

The Line command draws a two-dimensional or three-dimensional line. It can consist of between 2 and 200 points.

### Using the Command

Choose the Line command and set points for the line. You will see a rubber-band line connected to each point you set. When you have set the points, press **Enter** or double-click the mouse to end the command.

This command is similar to the Plane command except the Plane command creates a surface instead of a line.

**Hint:** You can use the Make Plane command to convert lines into planes so they can be shaded.

---

### Example: Add a line to your drawing.

Select the LINE command. Set a point for the beginning of the line. Set several other points in different locations for the body of the line. Set a final point for the end of the line and press **Enter**.

**See Also:** *Make Plane Command, Ortho Line Command, Plane Command*

Menu: DIMENSION  
Menu Command: LINE DISTANCE  
Point 1: First line  
Point 2: Second line

This command measures the shortest distance between two lines.

### Using the Command

Set points on the lines to be measured. The shortest distance between the lines will be displayed on the screen.

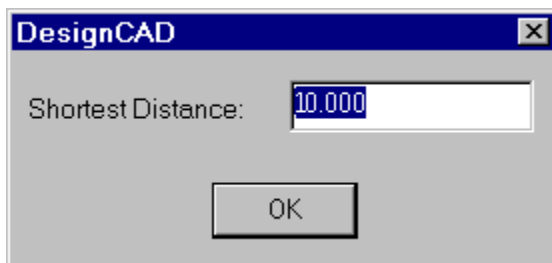

Example: Find the shortest distance between two lines that do not intersect. Select the LINE DISTANCE command and set a point on the first line. Set a point on the second line, and DesignCAD will display the shortest distance in a dialog box.

Menu: POINT

Menu Command: LINE PLANE

Point 1: Set a point on the intersecting line

Point 2: Set a point on the intersecting plane

The Line Plane command sets a point at the intersection of a line and a plane.

### Using the Command

Set one point on the line and a second point on the plane. If the line does not touch the plane, a point will be set where the intersection would be if the line were extended.

### Example: Find the intersection of a line and a plane.

Select the LINE PLANE command. Set a point on the line and another on the plane. The cursor will move to the intersection.

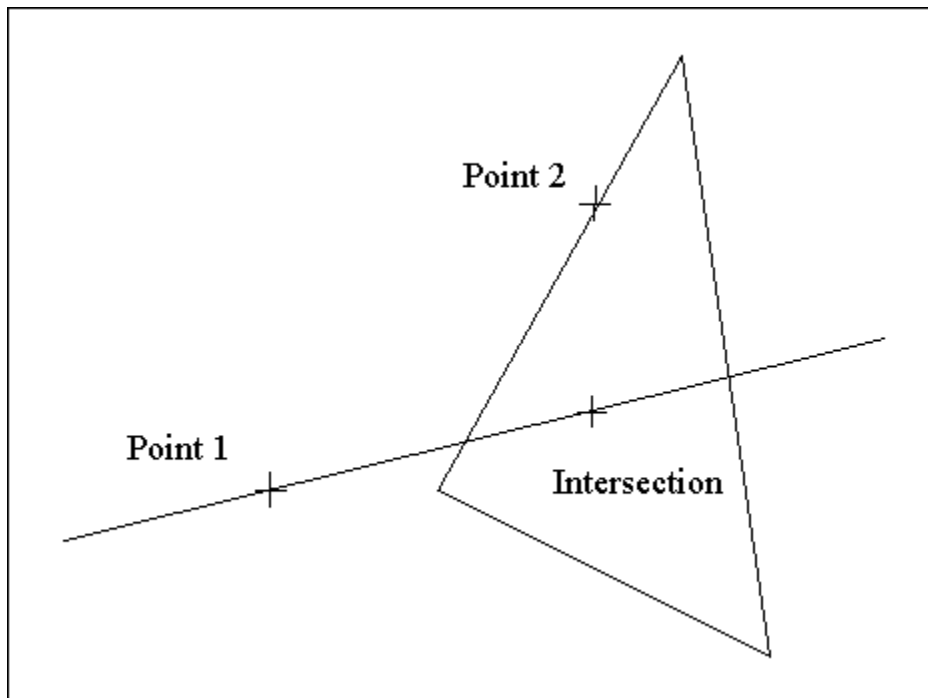

Menu: POINT  
Menu Command: LINE SNAP  
Shortcut Key: **K**

Toolbox Icon: 

This command moves the cursor to the nearest line and sets a point there. It can be very useful in conjunction with drawing commands. For example, if you are drawing a line and want one of the endpoints to lie exactly on another line, you can use Line Snap to accomplish this without having to "zero in" on the line.

### **Using the Command**

Choose the Line Snap command and set a point near the line to which you want to snap. The cursor snaps to the nearest point on the line and sets a point there.

### **Example: Set a point exactly on a line in your drawing.**

Choose the LINE command again and then, before setting a point, choose the LINE SNAP command. Move the cursor close to the line and click the left mouse button. The cursor snaps to the line and sets the starting point of your second line.



Menu: OPTIONS  
Menu Command: LINE STYLE BOX

Toolbox Icon: 







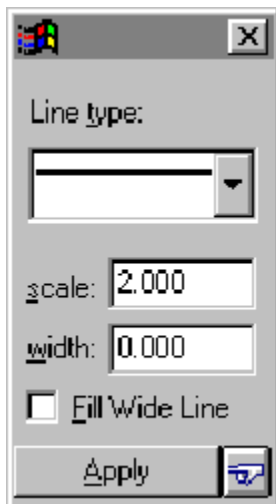





Use the Line Style Box command to open/close the Line Style Toolbox, which allows you to choose the current line style used by DesignCAD. Your choices affect lines, curves, arcs, circles, and ellipses. Solids and surfaces will always be drawn with solid lines of zero width.

### Using the Command

Choose LINE STYLE BOX in the OPTIONS menu or from the View Options folder, or choose the LINE STYLE TOOLBOX icon in the Main Toolbox. Set the line type, scale, width, and fill settings as desired. To apply the style to currently selected items, choose the Apply button.



Line type affects the basic appearance of the lines: solid, dotted, dashed, etc. In DesignCAD, there are 13 line types:

Solid	
Dashed	
Hidden	
Center	
Phantom	
Dotted	
Dashdot	
Border	
Divide	
Custom-1	
Custom-2	
Custom-3	
Custom-4	

SCALE affects the length of the repeating pattern in the lines. For example, if you draw a dashed line at a scale of 1.0 and another at a scale of 2.0, the dashes in the second will be twice as long, as will the gaps between them.

WIDTH affects the thickness of the line. Width is measured in drawing units, so it should generally be a rather small number.

FILL WIDE LINES will cause the lines with a width greater than zero to be filled in as solid lines. If this box is not checked, wide lines will be drawn as hollow lines.

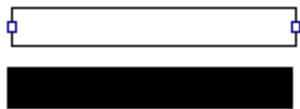

The APPLY button changes all selected items to the new line style.

**Note:** Width and Fill wide lines will only be used in 2-D Mode. When you cancel 2-D Mode, all line widths will appear to be zero. When you switch back to 2-D Mode, the wide lines will be restored.

---

Menu: EDIT  
Submenu: SELECTION  
Menu Command: LINE TO CURVE

The Line To Curve command converts all selected lines to curves, using the vertices of the lines as defining points for the curves.

### Using the Command

Select the line to convert. Run the LINE TO CURVE command. The line is converted to a curve.

#### Example: convert a closed line to a closed curve.

Draw a closed line, as shown, and select it. (the figure is shown in Point Select Mode to illustrate what happens to the points). Choose the Line to Curve command. The line is converted to a curve. Notice in the figure that the points for the curve are in the same locations as for the line.

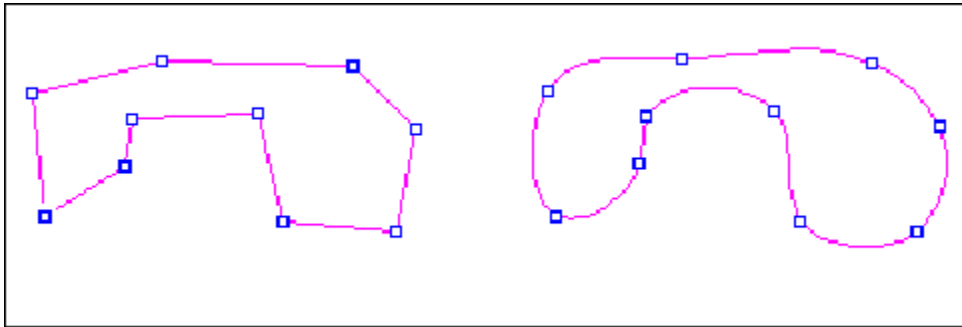

**See Also: Curve to Line**

Menu: TOOLS  
Submenu: DIGITIZER  
Menu Command: LOAD DIGITIZER MENU

The Load Digitizer Menu command loads the "data" portion of a digitizer menu. The "paper" portion of the menu should be attached to the digitizer before the digitizer is loaded. A maximum of 10 digitizer menus can be loaded at once.

### **Using the Command**

First, print the digitizer menu using a SCALE FACTOR of **1**. Next, attach the paper template onto the digitizer. Choose the LOAD DIGITIZER MENU command from the DIGITIZER submenu of the TOOLS menu. The Load Digitizer Menu box appears. Choose the digitizer menu name in the FILE NAME box, then click OK or press **Enter**.

Now set a point in the lower-left corner of the digitizer menu. A rubber-band box shows how the digitizer menu will be loaded. Set a point in the upper-right corner of the digitizer menu.

***See Also: Create Digitizer Menu Command, Save Digitizer Menu Command, Add Menu Item Command***

Menu: FILE

Menu Command: LOAD IMAGE FILE

Point 1: Lower-left corner for image placement

Point 2: Upper-right corner for image placement

The Load Image File command adds a graphic image from another file to your drawing. If you only set a single point, the image will use that point as the lower-left corner and be retrieved at full scale. If you set two points, the image will be scaled to fill a rectangle with those two points as opposite corners. The image is never rotated in 3-D space; it always appears “flat” relative to the screen, regardless of your viewing angles.

### **Using the Command**

Choose the LOAD IMAGE FILE command. Choose the type of file to be added to the drawing from the drop-down list in the FILES OF TYPE box. In the LOOK IN box enter the location of the bitmap. In the FILE NAME box enter the name of the file to load or select the file from the area below the Look In box.

This command is very useful in adding illustrations to your drawings. For example, it's possible to add a scanned photograph to be displayed along with your drawing.

### **Example: Insert a bitmap image into your drawing.**

Select the LOAD IMAGE FILE command. The LOAD IMAGE FILE box appears. Select the desired .BMP file and click OK. Set a point in your drawing for one corner of the insertion box. Move the cursor away from the first point to stretch the rubber-band box. When the box is the correct size, set the second point. The bitmap image will be inserted into your drawing in the space formerly occupied by the insertion box.

Menu: FILE  
Menu Command: LOAD SYMBOL

Point 1: First handle for symbol placement  
Point 2: Second symbol handle (optional)  
Point 3: Third handle (optional, only used for a 3D drawing or symbol)

The Load Symbol command loads a drawing symbol or merges an existing drawing with the current drawing.

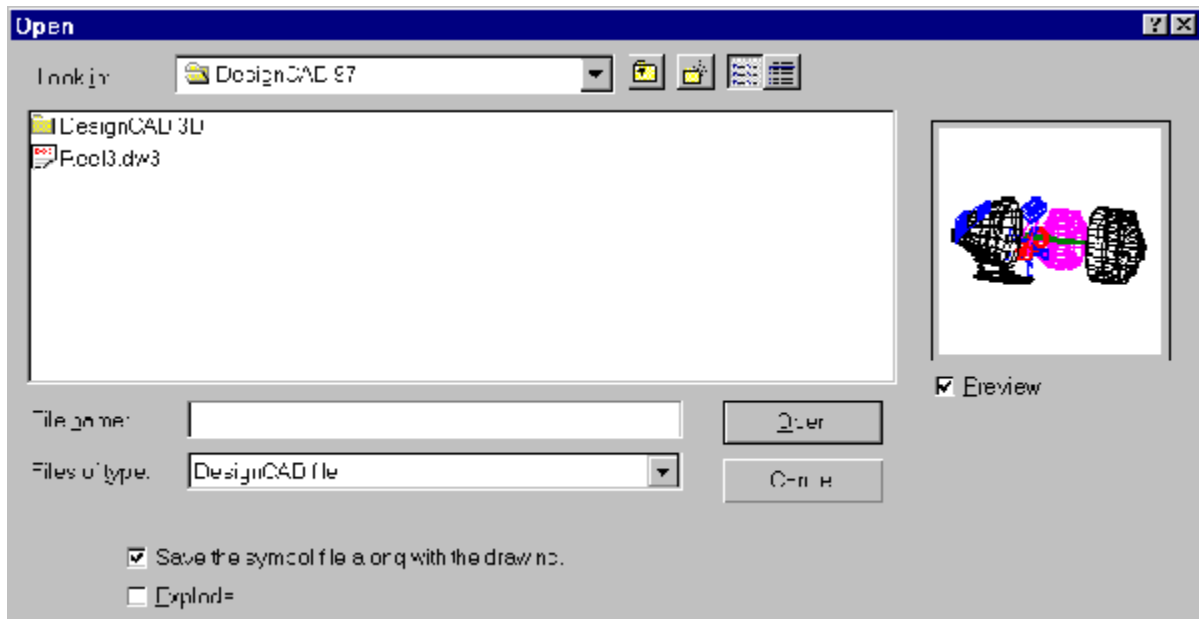

### Save the Symbol File Along with the Drawing

This checkbox determines whether the drawing being added or "merged" with the current drawing will be saved as a part of the drawing or just linked by a reference.

If the option is checked and the symbol is saved as part of the current drawing, the file size will be larger, and the drawing will not be updated when the symbol file is modified. The advantage is that the drawing will not be affected if the symbol file is deleted, or the drawing is opened on a computer that doesn't have a copy of the symbol file.

If the box is unchecked, the program adds an "insertion entity" to the drawing file. The symbol file is read every time the drawing is loaded. The symbol file must be present and in its original location. If the symbol file is modified, the change will be reflected in all the drawings using that symbol.

### Explode

In DesignCAD, symbols inserted into the drawing with the Symbol Load command are defined as single entities, whether they are saved as part of the drawing or linked to the drawing. That is, the entire symbol is selected, moved, and erased as a single entity. To change part of a symbol entity, you must first "explode" the symbol with the Explode command, or check the Explode option when the symbol is loaded.

To have the symbol loaded into the drawing as an exploded symbol so that it is not recognized as a single entity, make sure the Explode checkbox is checked. After a symbol is exploded, the symbol file is not read from disk when the drawing is loaded. A copy of the symbol is placed into the drawing instead of an insertion entity.

Note: If you are adding a file that is in DesignCAD 2D or 3D ASCII format to the current drawing, it will automatically be exploded. This is the only way DesignCAD 97 can use a DesignCAD ASCII file.

---

### **Using the Command**

Choose LOAD SYMBOL from the FILE menu. The OPEN dialog box appears. From the file list, select the name of the symbol you want to load. Then click the OK button.

A rubber-band box appears in the drawing. This shows the area of the symbol. Set one to two points to establish the location, size, and orientation of the symbol. To accept the symbol's size and orientation, set a point to establish the location, and then press **Enter**.

Menu: TOOLS  
Menu Command: MACRO EXECUTE  
Shortcut Key: %

This command runs a DesignCAD macro. A macro is a saved set of drawing actions that can be used later as a single command.

### **Using the Command**

After choosing the command, enter the macro name when asked for it, and then set a starting point for the macro. The macro begins its execution from that starting point.

### **Example: Suppose you need to draw a box of a specific size in several drawings.**

Select the MACRO RECORD command. Name the macro TEST.D3M and click OK. Draw a box and a sphere on the screen. Click the stop icon. The macro will be saved under the selected file name. Then, select the MACRO EXECUTE command and choose **TEST.D3M** from the list box. Set a starting point for the macro and DesignCAD will carry out the recorded series of actions.

***See Also: Macro Record Command***



Menu: TOOLS  
Menu Command: MACRO RECORD

A macro is a saved set of drawing actions that can be used later as a single command.

### Using the Command

When you use the Macro Record command, you are first asked for the macro name. Select a name and a location for the macro in the RECORD MACRO box. Then the Macro Record toolbox appears on the screen:



The icons represent RECORD/CONTINUE, PAUSE, STOP, and MACRO OPTIONS. The Macro Options icon brings up a dialog box in which you can set different options for the macro.



#### Record Layer

Checking this box causes the macro to run in the same layer in which it was created.

#### Record Command Parameters

Checking this box saves command bar information in the macro. For example, if you create a sphere with this option enabled, the macro will retain information such as number of latitudinal and longitudinal faces, and whether you created it in Vertex, Pole, or Midpoint format. If you leave this option disabled, then you will be asked for that information each time you run the macro.

#### Record Points

Checking this box causes the points set in specific drawing commands to be retained in the macro. This will affect dimensions of objects and their orientation to each other, but the absolute location of objects in the drawing is determined by the starting point that you select each time you run the macro.

#### Record Color

Checking this box configures the macro to create all objects in the same colors in which they were recorded. After you enter the macro name, everything you draw on the screen

becomes part of the macro. You can pause recording by clicking on the PAUSE button, and resume by clicking on the RECORD button.

When you are finished recording your macro, click the STOP icon or choose STOP RECORDING from the BASICCAD\MACRO menu. The macro can then be run using the Macro Execute command.

**Example: Draw a box and a sphere of specific sizes in several drawings.**

Select the MACRO RECORD command. Name the macro TEST.D3M and click OK. Draw a box and a sphere on the screen. Click the STOP icon. The macro will be saved under the selected file name. Then select the MACRO EXECUTE command and choose **TEST.D3M** from the list box. Set a starting point for the macro and DesignCAD will carry out the recorded series of actions.

***See Also: Macro Execute Command***

Menu: EDIT  
Menu Command: MAKE PLANE

The Make Plane command can be used to convert lines, curves, circles, and arcs into a plane. Planes can be shaded, whereas lines, circles, and arcs cannot.

### Using the Command

Select the line or lines to be converted to a plane. All selected lines should meet two conditions:

1. The lines should be connected sequentially, end to end;
2. The lines should all form a flat surface.

If the first condition is not met, DesignCAD brings up the following box:

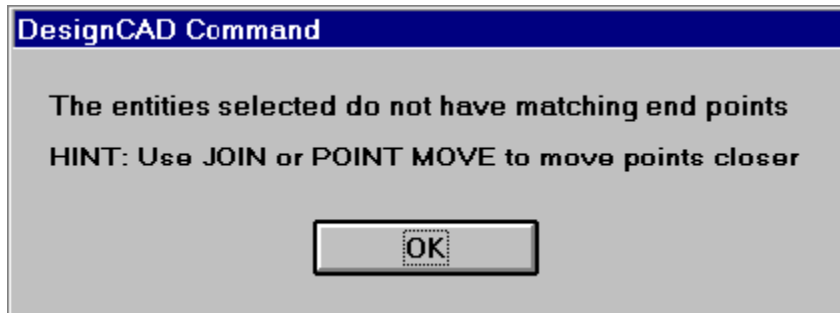

If the second condition is not met, DesignCAD brings up this box:

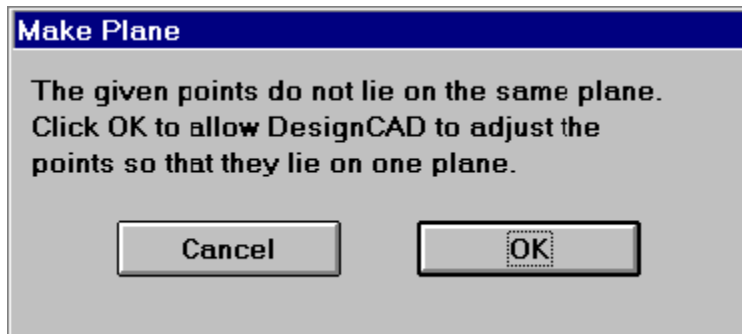

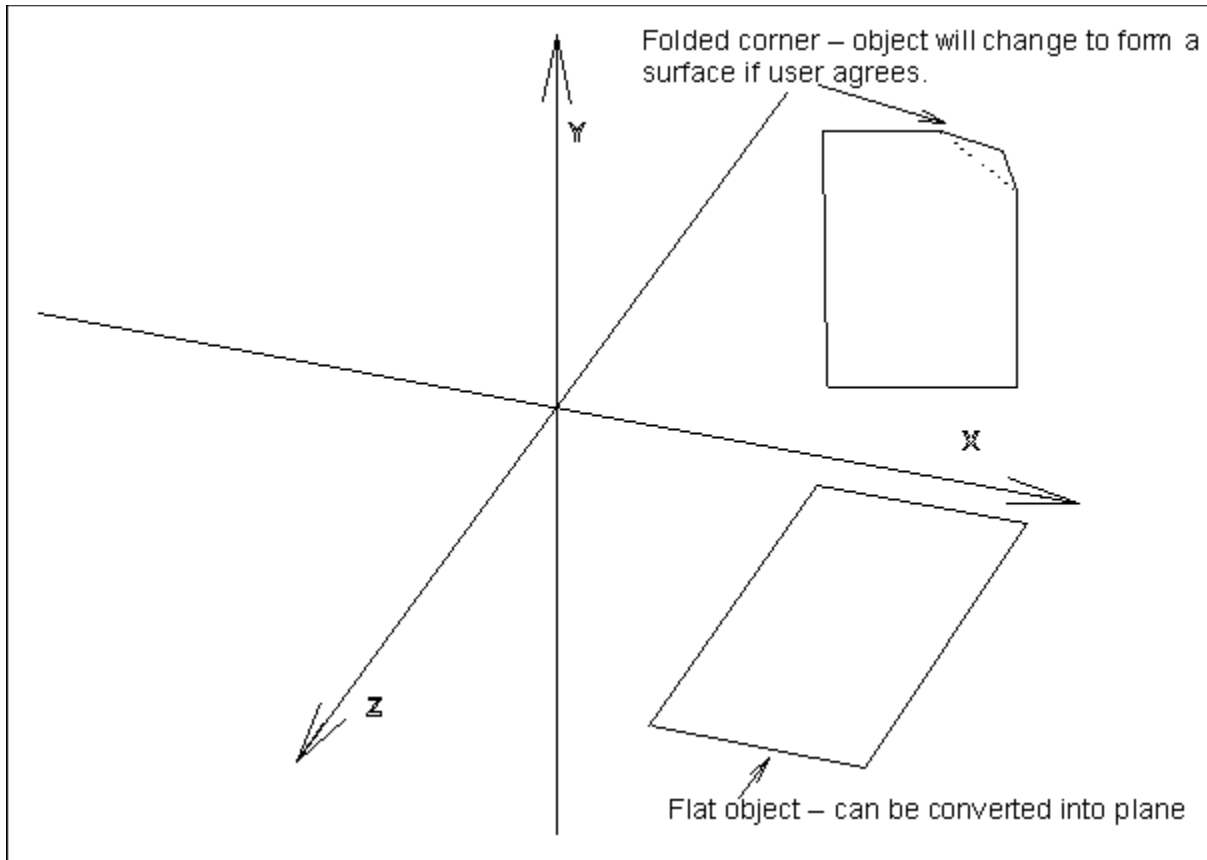

**Example: Make a plane out of three or four lines that meet at their endpoints and form a closed object (triangle, square, rectangle, rhombus, etc.).**

Select the lines as a group and choose the MAKE PLANE command. The lines will be converted into a plane surface.

Menu:                    OPTIONS  
Menu Command:        MATERIAL

The Material command brings up the Material Options folder which can be used to specify the material properties of an object. You can assign materials to an object or create your own materials.

After the material is selected, objects drawn will have that material property. For example, if you select the material Walnut and then draw a hemisphere, the hemisphere will look like Walnut wood. You can assign a material to an existing object with the Info Box.

### **Using the Command**

Choose the MATERIAL command from the OPTIONS menu. The MATERIAL OPTIONS folder appears. Choose the settings you prefer and click the OK button. Press CANCEL to return to the drawing without keeping any changes.

***See Also: Material Options***

Menu: OPTIONS  
Menu Command: OPTIONS

The Material Options folder can be used to specify the material properties of an object. You can assign materials to an object or create your own materials.

After the material is selected, objects drawn will have that material property. For example, if you select the material Walnut and then draw a hemisphere, the hemisphere will look like Walnut wood.

## Using the Command

Select the object to which you want to assign a material. Choose the OPTIONS command and click on the MATERIAL tab. The Material Options folder appears.

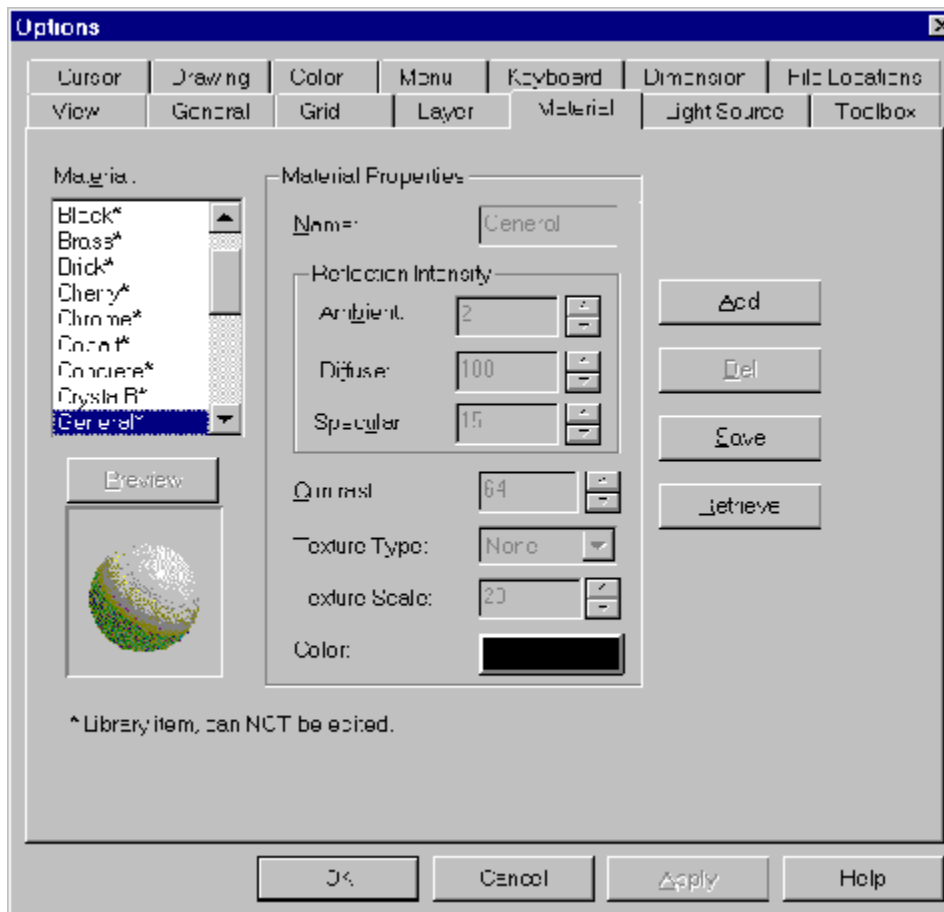

### Preview

- Displays a sphere composed of the selected material in smooth shade mode.

### Material Properties

#### Name

- Displays the name of the selected material. You can enter a name for new materials by clicking the box and entering the name you want.

#### Ambient

- This determines the amount of background light shining on the object. This dictates how much shadow is visible on a shaded object.

#### Diffuse

- Determines the amount of flat (not shiny) reflection you get from a shaded object.

#### Specular

- Determines how shiny (not flat) the material appears.

#### Contrast

- Determines how shiny the surface appears. The lower the setting, the shinier the surface appears.

#### Texture Type

- Set the texture of the material as NONE (smooth), MARBLE, GRAIN, WOOD, CEMENT, PATCH.

#### Texture Scale

- Determines the amount and size of the texturing.

#### Color

- Displays the color of the selected material. Clicking on this bar will bring up the color palette, where you can specify a color for your material by clicking on a color tile.

### **Add**

Creates a custom material. You can set preferences for all of the material's properties.

### **Del**

Deletes a material from the materials selection box.

### **Save**

Saves created materials as separate files.

### **Retrieve**

Retrieves a specified material file and inserts it into the selection box.

### **Example: Create a new material.**

Select the MATERIAL command and click the ADD button. Enter a name for your material in the NAME edit box. Enter values for the different material properties. Click the PREVIEW button to see what the material looks like with the current settings and play with the settings until the material is to your liking. When you have completed your material, click the SAVE button.

Menu: FILE  
Menu Command: MATERIAL LIST

The Material List command brings up a list of all the attributes and their quantities in the current drawing. This list can be copied to the clipboard, printed, or saved to a file.

Attributes generally refer to physical materials—lumber, bolts, screws, and other parts—used to build the object depicted in a drawing. The Materials List can be used for cost estimating, parts lists, and other functions that require a list of items used in a drawing.

### **Using the Command**

Choose the MATERIAL LIST command. The MATERIAL LIST box appears, showing a list of materials in your drawing and the count of each.

**Note:** The Material List command (in the File menu) should not be confused with the Material List in the Material Toolbox. "Material," as it is referred to in the Material Toolbox, affects the appearance of a shaded drawing. The Material List command provides a listing of Attributes placed in a drawing.

---

**Example: Show a list of all the labeled parts (Attributes) in the object you are drawing.**

Select the MATERIAL LIST command. The MATERIAL LIST box displays the names and quantities of all the Attributes in your drawing.



Menu: TOOLS  
Submenu: CUSTOMIZE  
Menu Command: MENU

The Menu command is a shortcut method of bringing up the Menu Options folder in the Options file box.

### **Using the Command**

Choose the MENU command from the CUSTOMIZE submenu in the TOOLS menu. The Options file box is displayed with the Menu Options folder showing. For a complete list of the options available in this folder, see Menu Options.

***See Also: Menu Options***

Menu:                    OPTIONS  
Submenu:                OPTIONS

The Menu Options folder allows you to customize how commands appear on menus. You can also add commands you create to any menu.

For example, you can group often-used commands on a particular pull-down menu or create a command with the BasicCAD programming language and add it to a menu. You can also record a macro and assign it to one of the pull-down menus.

### Using the Command

Choose the OPTIONS command from the OPTIONS menu. Click on the MENU tab. The Menu Options dialog box comes up on the screen.

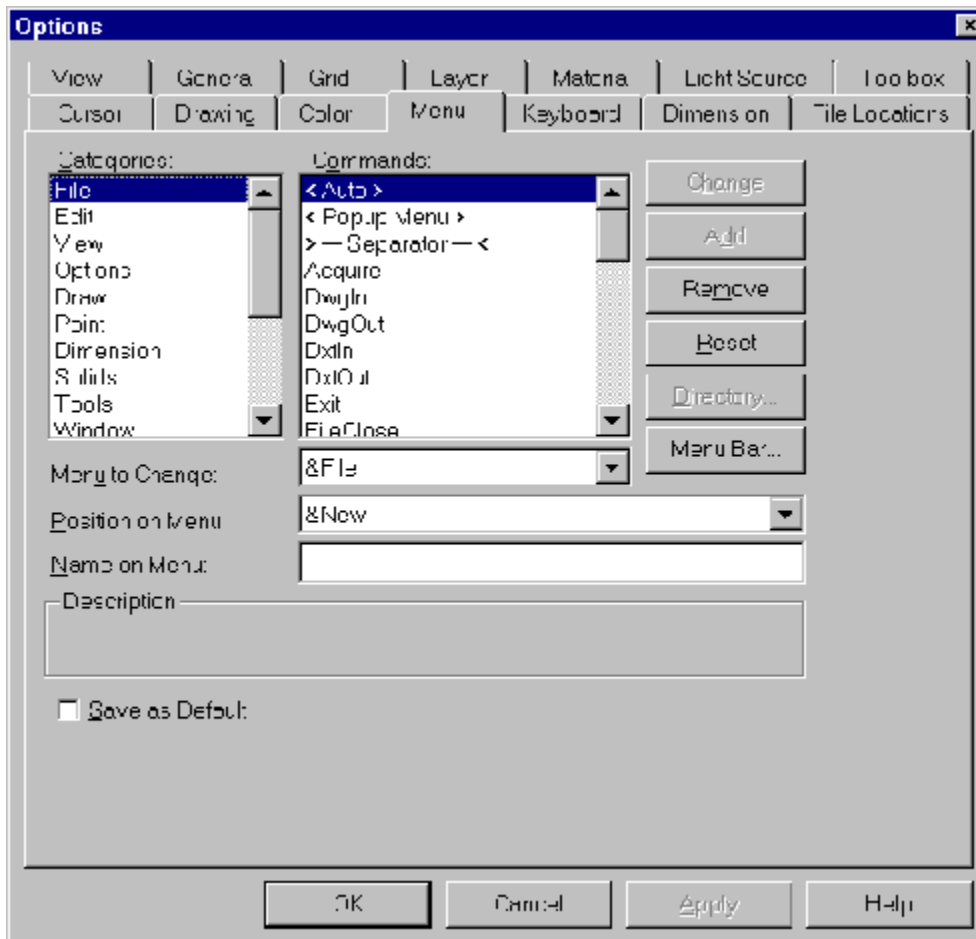

To find the menu you want to customize, click the appropriate menu command in the CATEGORIES box. These correspond to the commands on DesignCAD's main menu. When a main menu command is selected in Categories, commands on its corresponding pull down menu will appear in the Commands box.

When you're looking for an executable file in the lower four entries in the Categories box, the label on the Commands box changes to Files. The instructions below refer to the Commands

box, but they also apply to the Files box. The box name changes depending on what category you're looking at, but the box's function remains the same.

## **Add**

When you add a command to a pull down menu, it's always inserted above the command that appears in the Position on Menu box.

To add a command, select the main menu you want to add to in the CATEGORIES and MENU TO CHANGE boxes. Pick where you want to place the new command by scrolling down and selecting in the COMMANDS and POSITION ON MENU boxes. (You'll want to select the command that will be below your new command.)

Click in the NAME ON MENU box, enter a name for the command. Click ADD and then click OK to finish modifying the menu.

**Note:** To add an executable file, you must click the DIRECTORY button to find the file's location on the hard drive.

---

## **Delete**

To delete a command from a menu, scroll down and select the main menu in the CATEGORIES and MENU TO CHANGE boxes. Scroll down and select the command you want to remove in the COMMANDS, POSITION ON MENU and NAME ON MENU boxes. Click the REMOVE button, then click OK.

## **Change**

To change a command name, select the main menu in the CATEGORIES and MENU TO CHANGE boxes. Select the command to change in the COMMANDS and POSITION ON MENU boxes. Click in the NAME ON MENU box, enter a new name, then click CHANGE and OK.

## **Menu Bar**

You can add, remove or rename entire categories of commands from the main menu command bar by clicking the MENU BAR button, which brings up the Menu Bar dialog box.

Any change made to a main menu category will affect all its pull down menus. For example, when you remove a main menu command, all its corresponding pull down menu commands are removed as well.

For example, you could create a set of commands to handle certain symbols, and then add a command category named Symbols to the menu bar between the WINDOW and HELP commands.

To do this, enter the name of the new command category in the NAME ON MENU box, select where you want to place the command in the POSITION ON MENU box, then click the ADD button and click OK. You may now add specific pull down menu commands to the Symbols category by using the Add command.

## **Save as Default**

To keep the menu changes for the next time you run DesignCAD, you must check the SAVE AS DEFAULT box. If the box is not checked, your menu modifications will be in effect only for the current session and will be lost when you close DesignCAD.

## **Reset**

Return modified menus to their original DesignCAD defaults by clicking the RESET button and the OK button.

Menu: POINT  
Menu Command: MIDPOINT  
Shortcut Key: **Ctrl+K**

Toolbox Icon: 

**This command moves the cursor to the midpoint of the closest line and sets a point there.**

Using the Command

**Select the MIDPOINT command, move the cursor near the line to you want to snap to, and click the left mouse button.**

Example: Set a point on the midpoint of a line.

Choose the MIDPOINT command. Move the cursor near the line in your drawing and click the left mouse button. The cursor snaps to the midpoint of the line and sets a point there.

**Note:** In 2-D Mode, this command will snap to the midpoint of a line's *projection* on the XY plane, not to the midpoint of the actual 3-D line.

---

Menu: EDIT  
Submenu: SELECTION  
Menu Command: MIRROR  
Point 1: Location of mirrored object

The Mirror command is used to make a mirror image of a selection.

### Using the Command

Choose the MIRROR command. The Command Line contains four options for the Mirror command:



Normal to X Axis

- Selecting this option places a mirror which faces in the direction of the X-axis. That is, the mirror lies on the X axis and is perpendicular to it.

Normal to Y Axis

- This places the mirror perpendicular to the Y-axis.

Normal to Z Axis

- This places the mirror perpendicular to the Z-axis.

Custom Axis

- This option specifies a 3-D line perpendicular to the face of the mirror. You can use the option to create custom mirror effects, such as producing a mirror image facing at an angle 90 degrees away from the original.

To use the command, set a point for the location of the mirror image. The mirror image will be located at that point, and mirrored according to the option selected. If CUSTOM AXIS is selected, then the mirror will be normal (perpendicular) to the line between the selection handle and the point that was set.

### Example: Make a horizontal mirror image of an object.

Select the object and choose the MIRROR command. Select NORMAL TO X AXIS and set a point for the mirrored object's location. The object is mirrored horizontally.

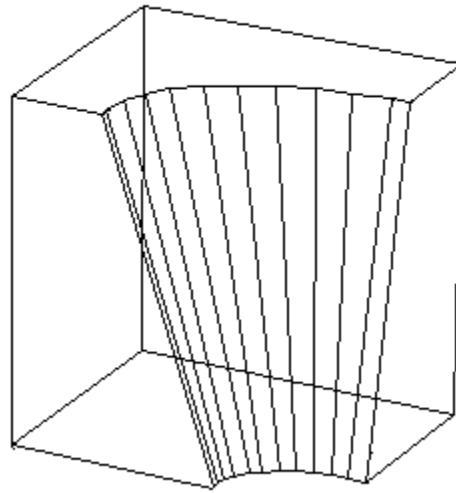
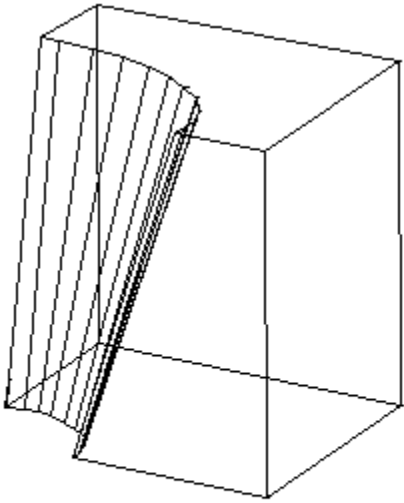

Mirror Horizontally

Menu: FILE  
Menu Command: *FILENAME*

DesignCAD 97 provides you with a list of recently used drawing files. The filenames appear on the list in order of their most recent use. To open one of these files, select it from the menu.

### **Using the Command**

Select the *FILENAME* of a file you have worked on recently from the listing in the *FILE* menu. CAD Viewer will open the file whether it was opened during the current drawing session or a previous one. This is a faster way of opening a recently used file than using the Open command and being forced to specify the path to the directory in which it is stored.



Menu: EDIT  
Submenu: SELECTION  
Menu Command: MOVE  
Shortcut Key: **M**  
Point 1: New location of the handle  
Point 2: New location of second handle (optional)  
Point 3: New location of third handle (optional)

The Move command moves a selected entity or group to another location. One, two, or three points may be used to specify the new location.

### Using the Command

To use the command, select the object or group to be moved. Choose the Move command. A rubber-band box appears. If the selection has only one handle, the first point you set places the selection handle at its new location with that handle. The size and orientation remain the same.

If you have placed two or three drawing handles with the Set Handles command, you can move the selection with those points. If a second point is used, you can adjust the selection's size with the second handle. If a third point is used, the selection will be positioned at an angle so that the three Block handles lie on the same plane as the three points set.

You can also activate this command by moving the cursor over the primary handle. When the cursor changes into a four-sided arrow, you can move the object in one of two ways:

1. Press the left mouse button and hold. Drag the selection to the new location.
2. Click the left mouse button once to lock the Move command. Drag, or use any of the point commands, to select a new location. If more than one handle has been set for the selection, you can set more than one point when you move the object.

This command is like the Duplicate command except that the selection is moved instead of copied.

### Example: Move an object to a new location in the drawing.

Select an object in the drawing. Next, choose the MOVE command. Move the cursor to the new location for the object. Set a point for the insertion. If you have set more than one handle for the object, you can set a point for each handle.

Menu: FILE  
Menu Command: NEW  
Shortcut Key: **Ctrl+N**



Toolbox Icon:

The New command opens a new drawing document. It does not close any drawing that you already have open. It simply opens an empty window of full-screen size, in which to build the new drawing.

### **Using the Command**

Choose the NEW command. A blank drawing appears on the screen, but it does not close the current drawing. You can switch from one drawing to the next using **Ctrl-F6**.

If you already have several documents open and try to start a new one, DesignCAD 97 may warn you that it's not possible to create an empty document.

In this case, close one or more of your drawings, or other open applications, and try NEW again. The number of documents that you can open depends on the amount of memory on your system, the number of other applications that are open, the complexity of each drawing, the number of view windows you have opened for each drawing, and other factors.

***See Also: Open Command, Close Command, Load Symbol Command, Save Command, Save As Command***

Menu: WINDOW  
Menu Command: NEW WINDOW

The New Window command opens a new view of a drawing. DesignCAD 97 allows several different windows, or views, to be opened simultaneously. These can be zoomed or panned independently of each other.

### **Using the Command**

Choose the NEW WINDOW command from the WINDOW menu. A new drawing window automatically opens. Change the window's view, size, and location as desired.

Menu: FILE  
Menu Command: OPEN  
Shortcut Key: **Ctrl+O**



Toolbox Icon:

The Open command opens a drawing file and loads it onto the screen as the current drawing.

### **Using the Command**

Choose the OPEN command. The OPEN box appears. In the FILE NAME box enter or select the name of the file you want to open. In the LOOK IN box select the location of the file. In the FILES OF TYPE box select the type of file you want to open. Click the OK button when you have entered the necessary information, or click the CANCEL button to return to the current drawing.

If you already have a drawing on the screen, it will not close that drawing but will open a second drawing.

If you already have several documents open and try to start a new one, DesignCAD 97 may warn you that it's not possible to create an empty document.

In this case, close one or more of your drawings, or other open applications, and try NEW again. The number of documents that you can have open depends on the amount of memory on your system, the number of other applications that are open, the complexity of each drawing, the number of view windows you have opened for each drawing, and other factors.

***See Also: Close Command, Load Symbol Command, New Command, Save Command, Save As Command***

Menu: OPTIONS  
Menu Command: OPTIONS  
Shortcut Key: **Q**

The Options command gives you the opportunity of setting a wide range of parameters that control the operation of DesignCAD. The Options command displays a number of options folders. For more information, refer to the individual entries listed in the "Command Reference" section of this manual:

- Color Options
- Cursor Options
- Dimension Options
- File Location Options
- General Options
- Grid Options
- Keyboard Options
- Layer Options
- Light Source Options
- Material Options
- Menu Options
- Text Options
- Toolbox Options
- View Options

Menu: POINT

Menu Command: ORIGIN

Point 1: New location for the drawing's origin

The Origin command can be used to set the origin, (location 0, 0, 0) anywhere in the drawing. This can be convenient if you want to use coordinates relative to a particular point on the drawing.

### **Using the Command**

Choose the ORIGIN command. Set a point anywhere on the screen. The location of this point becomes the new origin. The origin remains the same until it is changed again.

### **Example: Reset the origin of your drawing.**

Select the ORIGIN command. Move the cursor to the lower-left corner of the screen and set a point. The origin of the drawing will move to that location. Notice that the X,Y,Z location on the coordinate bar now reads 0, 0, 0 at the new origin.

Menu: VIEW  
Menu Command: ORIGINAL SIZE

The Original Size command lets you restore a zoomed drawing back to its original size.

### **Using the Command**

After changing the zoom percentage of one or more views with the Zoom commands, select the ORIGINAL SIZE command. All open views of the drawing are returned to their original zoom percentages.

**Note:** When a drawing is displayed at its original size, the Original Size command is grayed out and is unavailable.

---

Menu: EDIT  
Submenu: SELECTION  
Menu Command: ORTHO

The Ortho command forces selected lines to be vertical or horizontal. This command forces all line segments within 10 degrees of parallel with the X, Y, or Z axis to lie exactly parallel to that axis..

### Using the Command

Select the line to be straightened. Choose the ORTHO command from SELECTION submenu in the EDIT menu. The line will be converted to a vertical or horizontal entity.

### Example: Make an angled line horizontal.

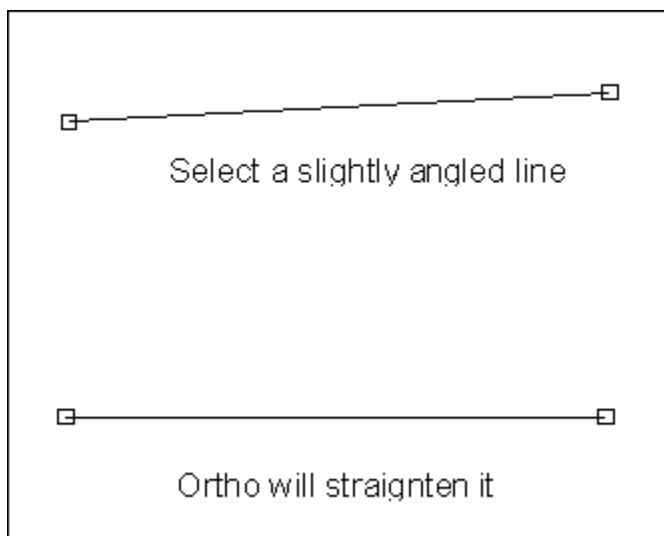



Menu: DRAW  
Submenu: LINES  
Menu Command: ORTHO LINE  
Shortcut Key: **H**

Toolbox Icon: 

Point 1: Beginning of line  
Point 2: End of first segment  
Point 3-200: End of second and subsequent segments (optional)

The Ortho Line command draws lines with segments that are parallel to the X, Y, or Z axis. If you set points that are not parallel to one of these axes, the Ortho Line command automatically shifts the line to be parallel to the nearest matching axis.

### Using the Command

Choose the ORTHO LINE command. Set a beginning point for the ortho line. Set any number of points up to 200 to draw the line. Then press **Enter** or double-click the mouse to end the command.

### Example: Draw a line parallel to the X axis.

Select the ORTHO LINE command and set a point on the screen. Move the cursor to the right and up. Notice that the rubber-band line only moves along the X axis. Set a point for the body of the line and move the cursor up. Again the line is drawn exactly parallel to an axis. Set another point and press **Enter** to complete the command and add the line to the drawing.

Menu: VIEW

Menu Command: PAN

Toolbox Icon:



Point 1: Specific point to be moved

Point 2: New screen location for Point 1

The Pan command is used to slide the drawing around on the screen. To pan a drawing, select the command and then drag the cursor across the screen. The drawing will be dragged to its new location.

### Using the Command

Choose the Pan command. The cursor turns into a four-headed arrow. Drag the mouse across the screen until the drawing is in the position you want. Then release the mouse button.

You can also set a point for the "source" and "destination" of the drawing. The first point is the original location and the second point is the new location for that part of the drawing.

**Example: Slide your entire drawing around on the screen.** Select the PAN command and set a point on one of the objects. Move the cursor around the screen and notice how all objects in the drawing move as a group. When the drawing is positioned to your liking, set the second point.

Menu: DRAW  
Submenu: LINES  
Menu Command: PARALLEL  
Shortcut Key: =



Toolbox Icon:  
Point 1: Existing line  
Point 2: Location for parallel line

The Parallel command draws a line parallel to any existing line, curve, or arc.

### Using the Command

Choose the PARALLEL command. Set a point on the original line and a point for the location of the parallel line.

This command works on three-dimensional lines as well as lines that lie on a single plane.

### Example: Draw a line parallel to a multi-segment line.

Select the PARALLEL command. Set a point on the line and move the cursor away from it. A rubber-band line is drawn parallel to the first line at the current cursor distance. When the line is where you want it, set the second point.

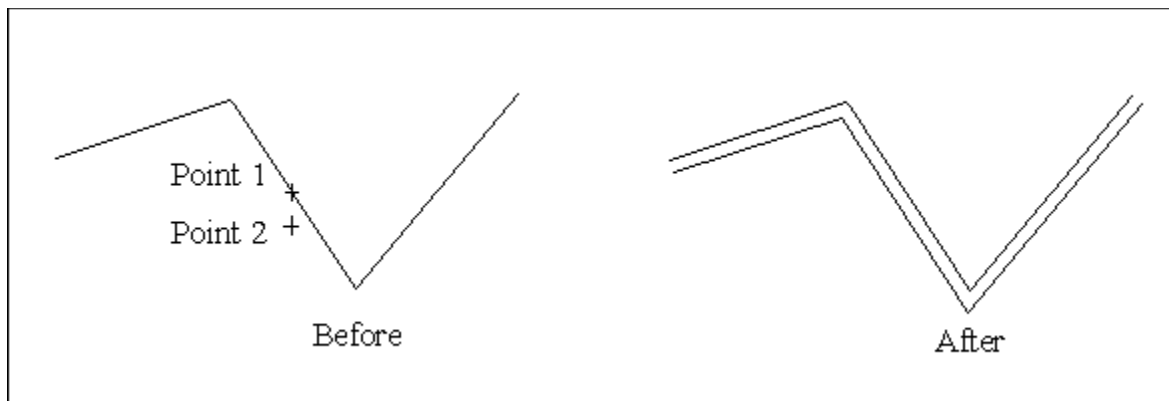

Menu: DRAW  
Submenu: LINES  
Menu Command: PARALLEL BY DISTANCE



Toolbox Icon:  
Point 1: Line to be paralleled.  
Point 2: Direction of parallel line from original line.  
Point 3: Location of next parallel line (optional)

The Parallel by Distance command draws a parallel line a specified distance from any other line or curve. The distance of the parallel is set in the Command Line. The direction of the parallel from the original line is established by setting a point on the screen.

### Using the Command

Choose the PARALLEL BY DISTANCE command in the Toolbox. Enter how far you want the parallel from the original line in the DISTANCE box in the Command Line.

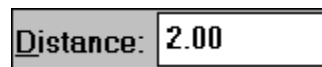

Set a point on the original line. A rubber-band line shows how the parallel line will look. Next, move your cursor to the side of the original line that you want the parallel to be drawn and set a point. A parallel line will be drawn at the specified distance. Keep setting points until you have all the parallel lines you want, and press **Enter** to end the command.

### Example: Draw a parallel line 4 units from another line.

Choose the PARALLEL BY DISTANCE command in the Toolbox. Enter **4** in the DISTANCE box in the Command Line. Set a point on a line in your drawing. Move the cursor to the side of the line that you want the parallel to be drawn. A rubber-band line shows how the parallel line will be drawn. Click the left mouse button to draw the parallel line and press **Enter** to finish.

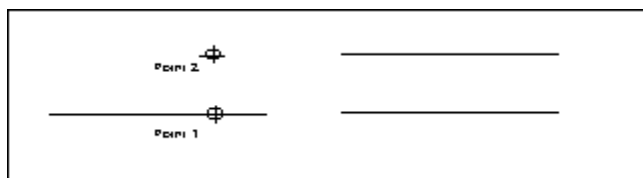

Menu: VIEW  
Menu Command: ALIGN DRAWING  
Point 1: Point on the digitizer pad  
Point 2: Corresponding point on the screen  
Point 3: Point on the digitizer pad  
Point 4: Corresponding point on the screen

The Align Drawing command synchronizes the digitizer pad with the display quickly and easily.

### **Using the Command**

Choose ALIGN DRAWING from the VIEW menu. Set a point of reference on the digitizer pad. Set a second point with regard to the drawing screen that will correspond to the first point set on the digitizer pad. Now set a third point as another point of reference on the digitizer pad. Finally, set the fourth point with regard to the drawing screen; this point will correspond to the third point which was set with respect to the digitizer pad. This will tell DesignCAD the relationship that the area of the digitizer pad should have with the drawing screen.

**Note:** DesignCAD will ignore this command if you do not have a digitizer or if it is not recognized by your computer.

---

**See Also:** *Digitizer Tracing Mode*

Menu: ANIMATION  
Menu Command: ANIMATION MODE

The Animation Mode command is used to animate or add motion to objects in a DesignCAD drawing.

This command is also used to produce animated AVI video files that can be played by Windows' Media Player and other video player applications. Animation Command will also produce VRML files, which can be used to animate a drawing for display on the Internet.

DesignCAD animation works on the same principle used by motion pictures and animated cartoons. A series of drawing images are recorded one frame at a time, with the position of the animated object changed slightly from frame to frame. When all the frames are displayed in rapid succession, the animated drawing creates the illusion of motion and continuity for the viewer.

DesignCAD animation is performed by establishing keyframes of a drawing at the start, middle and end of an animated sequence. These keyframes serve as guide posts for the sequence. You must select how much time (how many frames) will pass between keyframes. You must also manipulate and move the drawing object between keyframes. This tells DesignCAD what and how much "movement" to display in relation to various times in the animation sequence.

### Using the Command

You should have a drawing loaded when you start the Animation Command.

**Hint:** Pay attention to where you set the selection handle on the animated object. The selection handle serves as a reference point for all the movement, rotation or scale changes that will occur in your animation.

---

With the drawing open, choose ANIMATION MODE from the ANIMATION menu. The Animation toolbox and Time Line dialog box appear.

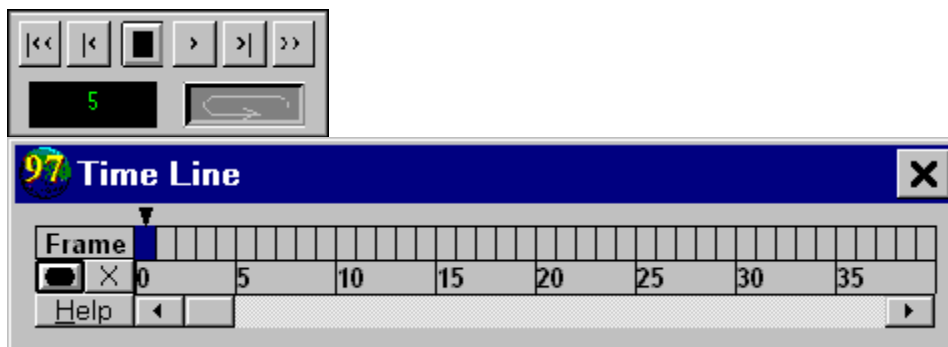

To set the first keyframe, make sure the box above the zero is highlighted in the Time Line (the current frame will be highlighted with a blue box and an arrowhead above it) and click the SET KEYFRAME button .

Begin to set the next keyframe by clicking in the box above the number for the next frame that will be a keyframe. Notice that the box you click is filled with blue and an arrowhead will appear

above it. The box corresponding to the frame of the first keyframe that you set is filled with black, indicating that it is a keyframe.

The number of frames left between keyframes determines the size of the animation increments in the final animation. In other words, if you are rotating an object 90 degrees between two keyframes that are ten frames apart (frames 0 and 10), in the final animation the object will rotate 9 degrees per frame (90 divided by 10 is 9).

**Hint:** Animation runs at about 15 frames per second, so 30 frames would equal approximately two seconds worth of animation.

---

Now enter all pertinent motion information for your animated object. This is the amount and type of movement you want to occur from the first keyframe to the second keyframe. You can use the Move, Rotate, Scale or use any combination of these commands.

Once you have moved the object in the desired manner, verify that you have highlighted the box above the number you want to set as the second keyframe and click the SET KEYFRAME button to lock in the keyframe.

Repeat this series of actions as many times as necessary to complete your animation. If you make a mistake and want to delete a keyframe, in the Time Line highlight the box above the keyframe you want to delete and click on the DELETE KEYFRAME button .

**Note:** Don't forget to record a keyframe any time you change the direction of movement, the direction of a rotation, etc. For example, if you are going to move an object to the left and then up in your animation, make sure you record a keyframe before you move the object up. If you don't record a keyframe after you move the object to the left but wait until after you have moved the object to the left and then up, DesignCAD doesn't know that you wanted to show movement to the left and then upward movement. The object will move diagonally when the animation is played.

---

## Playing and Saving An Animation Sequence



To rewind your animation, click on the REWIND button.



Click on the BACK ONE FRAME button to move the animation backward one frame.



Click the STOP button to stop an animation that is playing.



Click the PLAY button on the Animation toolbox to play and examine the animation.



Click the FORWARD ONE FRAME button to move the animation forward one frame.



To fast forward to the end of the animation, click on the FAST FORWARD button.

If you are finished, save your work as an animation template. Select the SAVE ANIMATION TEMPLATE command from the ANIMATION menu. Enter a name for the animation in the dialog box and then click OK. The animation template will be saved as a part of the drawing file.

## **Playing Animation in DesignCAD**

To play an animation, display the drawing you animated, then choose ANIMATION | LOAD ANIMATION TEMPLATE. Select the template file that animated the drawing, and click OK. You can now click the play button to run your animation.

**Hint:** The animation tool bar remains in place until you deselect the ANIMATION MODE command under the ANIMATION menu.

---



Menu: ANIMATION  
Submenu: EXPORT  
Menu Command: AVI

The AVI command exports an animation produced in DesignCAD as an AVI file.

### **Using the Command**

Record an animation template or open an existing animation template using the LOAD ANIMATION TEMPLATE command in the ANIMATION menu. Create an AVI file from your template by clicking ANIMATION|EXPORT|AVI. Give the file a name, then click SAVE.

AVI files are very large, so DesignCAD gives you the option to save the file uncompressed or with one of six other compression ratios. Click the menu arrow and scroll to select a compression format. Select Full Frames (Uncompressed) for the best results then click OK.

***See Also: Animation Mode Command, Load Animation Template Command, Save Animation Template Command, VRML Command***

Toolbox Icon:



The Command Dialog button is a toggle which displays or hides the dialog box for the current drawing command.

### **Using the Command**

Select a drawing command. The Command Dialog button is pressed in, and if there are any options for that command the dialog box appears. Click on the Command Dialog button to release it. The dialog box for the drawing command is hidden and your view of the drawing screen is unobscured. If you decide that you need to set the options for the drawing command, click the Command Dialog button again and the dialog box will reappear.

Menu: TOOLS  
Menu Command: CONTINUE RECORDING

The Continue Recording command restarts the recording of a macro. After suspending the recording of a macro, click the CONTINUE RECORDING button to resume recording.

### **Using the Command**

After stopping or pausing a macro recording, choose the CONTINUE RECORDING command. The macro resumes the recording.

***See Also: Macro Record Command, Stop Recording Command, Pause Recording Command***

Menu: ANIMATION  
Menu Command: CONTROL PANEL

The Control Panel command is a toggle that hides or shows the Animation Control Panel depending on the panel's current status.

### Using the Command

While in Animation Mode, select the CONTROL PANEL command from the ANIMATION menu. If the Animation Control Panel was visible, it will be hidden. If the Control Panel was hidden, it will be made visible.



**See Also:** *Animation Mode Command, Time Line Command*

Menu: ANIMATION  
Submenu: WALK  
Menu Command: CREATE WALK THROUGH

This command is not active until Animation Mode is enabled by selecting the ANIMATION MODE command from the animation menu. The Create Walk Through command begins the recording of a walk through.

### **Using the Command**

Make sure that the drawing is in Animation Mode. Then select the CREATE WALK THROUGH command from the WALK submenu of the ANIMATION menu.

The controls for the Create Walk Through command are identical to those of the Set View command. Place the cursor in the active view window. Next press and hold the left mouse button while dragging the cursor across the screen with the mouse. The view changes as you drag the mouse.

You can change the viewing distance by moving the cursor in and out on the Z axis (by pressing **Ctrl+Shift** and moving the mouse up or down). Press **Enter** or click the OK button when you have finished the Walk Through.

### **Move Target Point**

This option lets you move the drawing to the left, to the right, up or down without rotating it. Pick a portion of the drawing (a particular corner of a box for example) that you want to move to a certain point on the drawing window. Check the MOVE TARGET POINT option and move the cursor to the point on the screen to which you want to move a portion of the drawing (the corner of the box you picked). Click and hold the left mouse button and drag the cursor to the point in the drawing that the item you wanted to move to a new location (the corner of your box) occupied before you started moving it. When you reach the point on the screen at which the item was located, release the mouse button. The item you wanted to move will now be located at the point in the drawing where you started dragging the cursor. The important thing to remember is to decide in which direction you want the drawing to move and then drag the cursor in the opposite direction.

### **Run Walk Through AVI After Creation**

This option automatically starts playing the Walk Through as soon as you finish creating it.

**See Also:** *Run Walk Through Command*

Menu: EDIT  
Menu Command: HIDDEN EDGE

The Hidden Edge command can be used to erase cut-plane lines which are sometimes a result of the Cut Plane, Plane Subtract, and Subtract commands.

### Using the Command

After executing a Cut Plane, Plane Subtract, or Subtract command, select the HIDDEN EDGE command from the EDIT menu. Set a point on one of the cut-plane lines so that it will be hidden from the view or from a printout of the drawing.

### Example: Subtract one box from another, then use the Hidden Edge command to hide any cut-plane lines.

Draw two boxes of different sizes. Draw the smaller box so that it is contained by the larger box with respect to the XY plane but intersects both ends of the larger box with respect to the YZ plane.

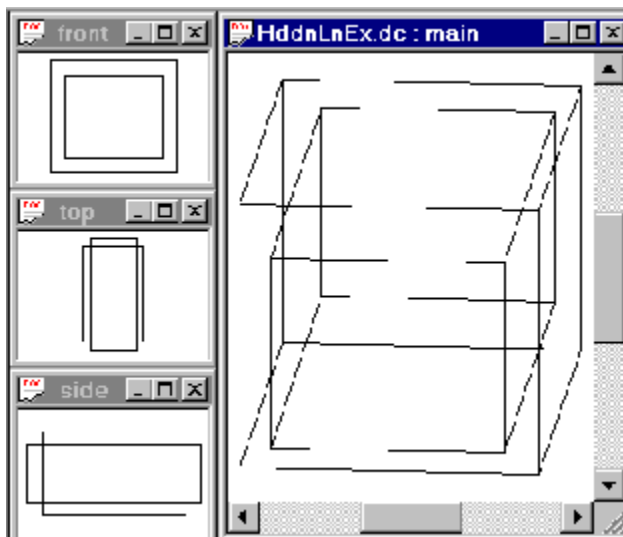

Use the SUBTRACT command to subtract the smaller box from the larger box. Notice the cut-plane lines which are a necessity of this kind of operation. Choose HIDDEN EDGE from the EDIT menu. Set a point on one of the cut-plane lines. The cut-plane line will be removed from the view and will not be printed in subsequent printouts. Repeat the Hidden Edge command as many times as desired.

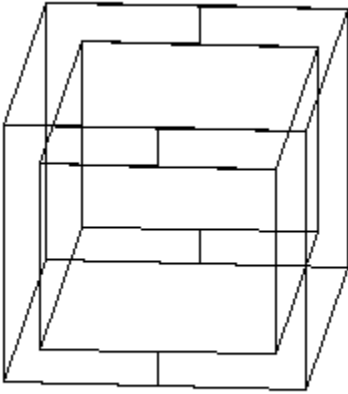

**Before**

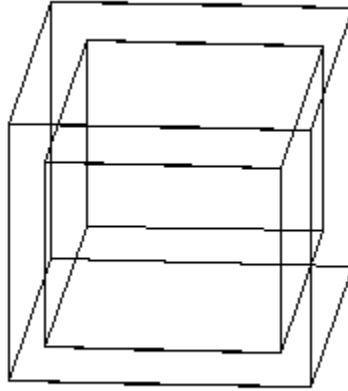

**After**

Menu: ANIMATION  
Menu Command: LOAD ANIMATION TEMPLATE

The Load Animation Template command opens an animation template that has been produced in Animation Mode and then saved as a part of the drawing file with the Save Animation Template command.

### **Using the Command**

After producing an animation in Animation Mode, save your work as an animation template so that it can be opened and viewed later. Select the SAVE ANIMATION TEMPLATE command from the ANIMATION menu. Enter a name for the animation in the dialog box and then click OK.

**Note:** The animation template is saved as a part of the drawing file it was created with and can only be opened later with the Load Animation Template command if the drawing file is open in DesignCAD.

---

**See Also:** *Animation Mode Command, Save Animation Template Command*



Menu: TOOLS  
Menu Command: MACRO TOOLBOX

This command is a toggle command that either displays or hides the Macro Toolbox, depending on the current status of the toolbox. The following macro options are available in the Macro Toolbox: Continue, Pause, Record Options, and Stop.

### Using the Command

After selecting the MACRO RECORD command, bring up the Macro Toolbox by choosing the MACRO TOOLBOX command. To hide the toolbox choose the MACRO TOOLBOX command again. This command is not available until you choose the Macro Record command.



Menu: TOOLS  
Menu Command: PAUSE RECORDING

The Pause Recording command suspends the recording of a macro. Click the PAUSE button if you want to pause during the recording of a macro.

### **Using the Command**

While recording a macro, choose the PAUSE RECORDING command. The macro stops recording until you choose the CONTINUE RECORDING command.

***See Also: Macro Record Command, Stop Recording Command, Continue Recording Command***

Menu: TOOLS  
Menu Command: RECORD OPTIONS

The Record Options command can be activated while the macro is being executed. This command allows you to save and change options within the macro.



The Record Options command only allows you to change "Save" macro options:

#### Record Starting Point

Choose this box to record a starting point for the macro. If this option is used when the macro is recorded, a starting point can be set when the macro is executed.

#### Record Layer

Choose this box to record layer information such as layer color, layer name, and current layer with the macro.

#### Record Command Parameters

Choose this box to record all drawing options including color, line type, dimension options, and layer options. However, some information entered in the Command Line or in the Text Block dialog box is not recorded with this command.

#### Record Points

Choose this box to record any points set within the macro.

#### Record Color

Choose this box to record the drawing's current color with the macro.

#### Record Line Style

Choose this box to record the drawing's current line style with the macro.

**Note:** You can also assign Toolbox buttons to the macros you create. See the Toolbox Options entry in the "Command Reference" section of this manual for more information.

---

Menu: ANIMATION  
Submenu: WALK  
Menu Command: RUN WALK THROUGH

The Run Walk Through command begins the playback of an AVI file created with the Create Walk Through command.

### **Using the Command**

After creating a Walk Through with the Create Walk Through command, select the RUN WALK THROUGH command. The Walk Through begins to play.

Menu: ANIMATION  
Menu Command: SAVE ANIMATION TEMPLATE

The Save Animation Template command saves an animation that has been produced in Animation Mode.

### **Using the Command**

After producing an animation in Animation Mode, save your animation so that it can be opened and viewed later. Select the SAVE ANIMATION TEMPLATE command from the ANIMATION menu. Enter a name for the animation in the dialog box and then click OK.

**Note:** The animation template is saved as a part of the drawing file it was created with and can only be opened with the Load Animation Template command if the drawing file is open in DesignCAD.

---

**See Also:** *Animation Mode Command, Load Animation Template Command*

Menu: EDIT  
Menu Command: SELECTION FILTER  
Shortcut Key: **Shift+F**

The Selection Filter command allows you to restrict the type of entities that are selected when a selection box is dragged around several objects in a drawing. This allows you to quickly drag a selection box around a group of entities and select only certain entities instead of everything inside the box.

### Using the Command

Choose the SELECTION FILTER command from the EDIT menu. The Selection Filter dialog box appears. To enable a selection filter, click on the checkbox to the left of the entity characteristics you want to restrict. Some of the Selection Filter types allow you to specify characteristics such as color or entity type. When you next use a selection box, only those entities you enabled will be selected.

To turn off a selection filter, choose the SELECTION FILTER command from the EDIT menu. The Selection Filter dialog box appears. Disable the filter by clicking on the checkbox to the left of the entity or entities you want to turn off.

To set options for a particular entity's selection, click the appropriate setup button.

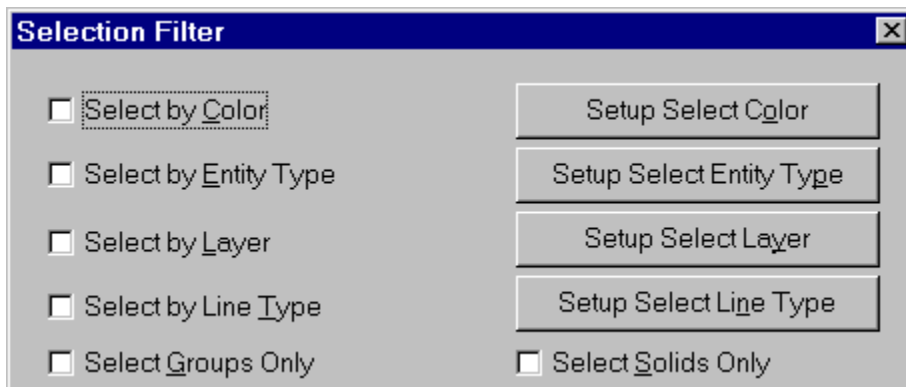

### Color Selection Filter

This filter lets you select entities by color. To add a color to the filter so items of that color may be selected, highlight the color in the AVAILABLE COLORS area and click ADD. To remove a color from the filter so items of that color will not be selected, highlight the color and then click DELETE. Click OK to return to the Selection Filter dialog box.

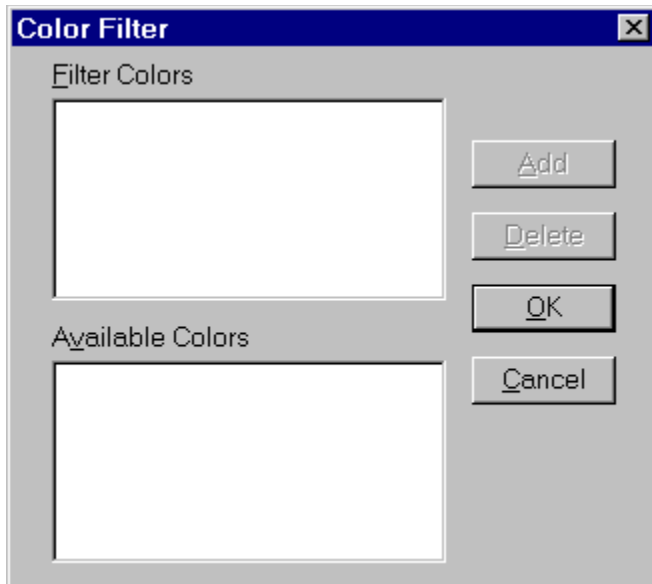

### Entity Type Selection Filter

You can pick any entity or combination of entities for a selection box to select. Click to place a check mark in the box to the left of the entity type you want to select, then click OK.

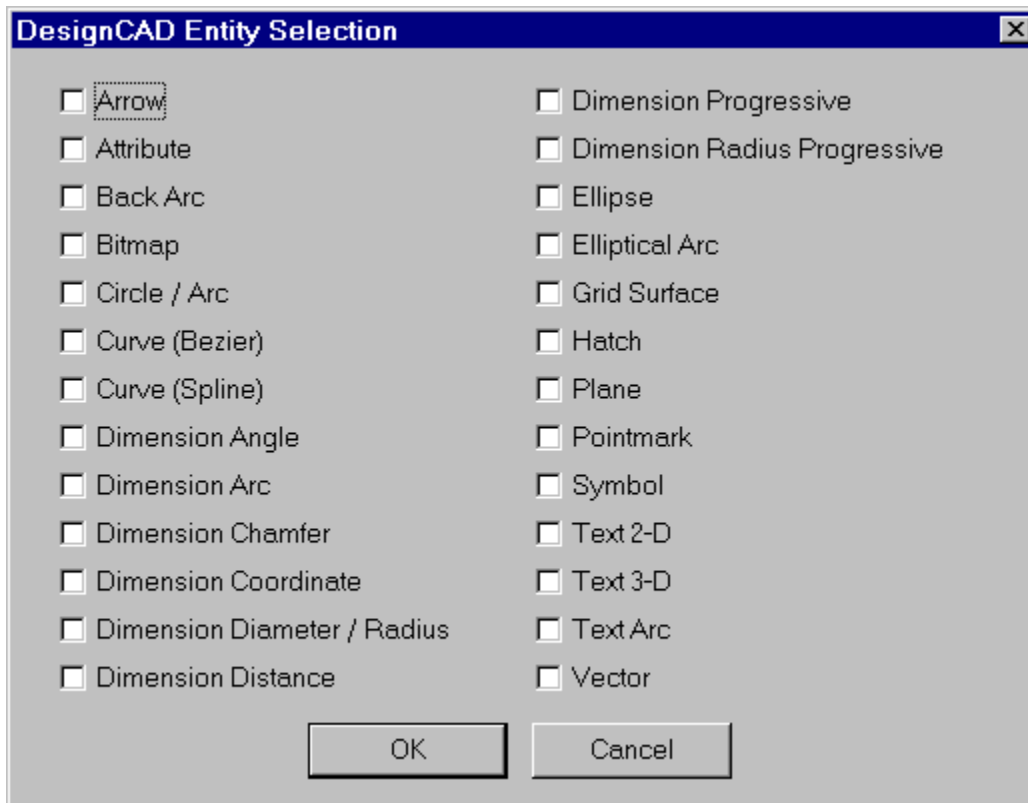

### Layer Selection Filter

This filter lets you select entities by layer. To add a layer to the filter so items in that layer may be selected, select the layer number from the list box and click ADD. To remove a layer from the filter so items in that layer will not be selected, highlight the layer number in the area to the left of the list box and then click DELETE. Click OK to return to the Selection Filter dialog box.



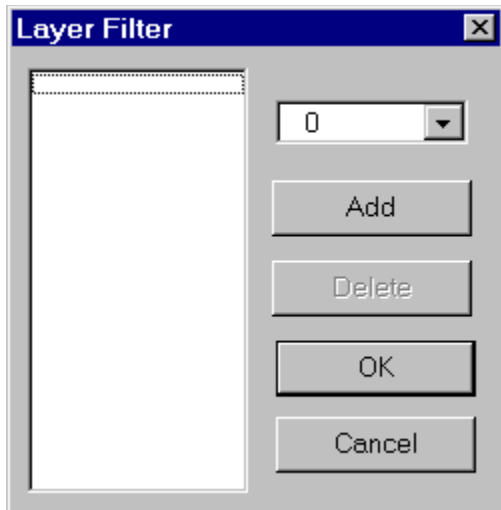

### **Line Type Selection Filter**

You can pick any line type or several line types to enable them to be selected. To add a line type to the filter so items of that line type may be selected, select the line type from the list box and click ADD. To remove a line type from the filter so items of that line type will not be selected, highlight the line type in the area to the left of the list box and then click DELETE. Click OK to return to the Selection Filter dialog box.

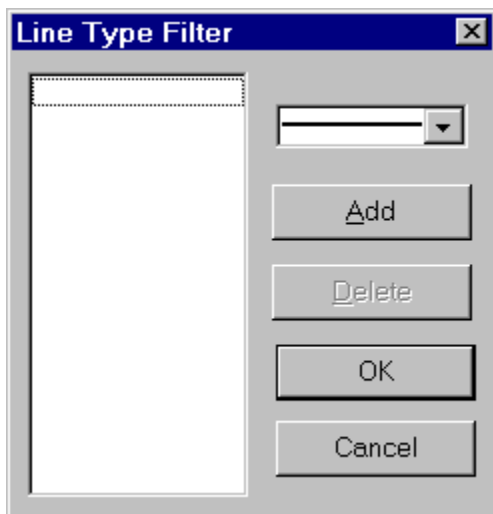

### **Group Entity Selection Filter**

When this Selection Filter is enabled, only groups may be selected.

### **Solid Entity Selection Filter**

When this Selection Filter is enabled, only solids may be selected.

Menu: FILE  
Submenu: SEND  
Menu Command: ALL OPEN DOCUMENTS

The Send All Open Documents command is a Windows 95 function that lets you send all the open drawings through Microsoft Exchange for electronic mail and fax functions. For more information, please refer to your Windows 95 documentation.

Menu: FILE  
Submenu: SEND  
Menu Command: *CURRENT DOCUMENT*

The Send Current Document command is a Windows 95 function that lets you send the current drawing through Microsoft Exchange for electronic mail and fax functions. For more information, please refer to your Windows 95 documentation.

Menu: TOOLS  
Menu Command: STOP RECORDING

The Stop Recording command ends the Macro Record command.

### **Using the Command**

After you have finished recording a macro, choose STOP RECORDING from the TOOLS menu. The macro will be saved under the file name entered in the Macro Record command.

***See Also: Macro Record Command, Record Options Command***

Menu: FILE  
Menu Command: SYMBOL LIBRARY

The Symbol Library command works like the Load Symbol command, but it brings up a dialog box that shows small preview images or "thumbnails" of the symbols that are available in the different symbols libraries that come with DesignCAD.

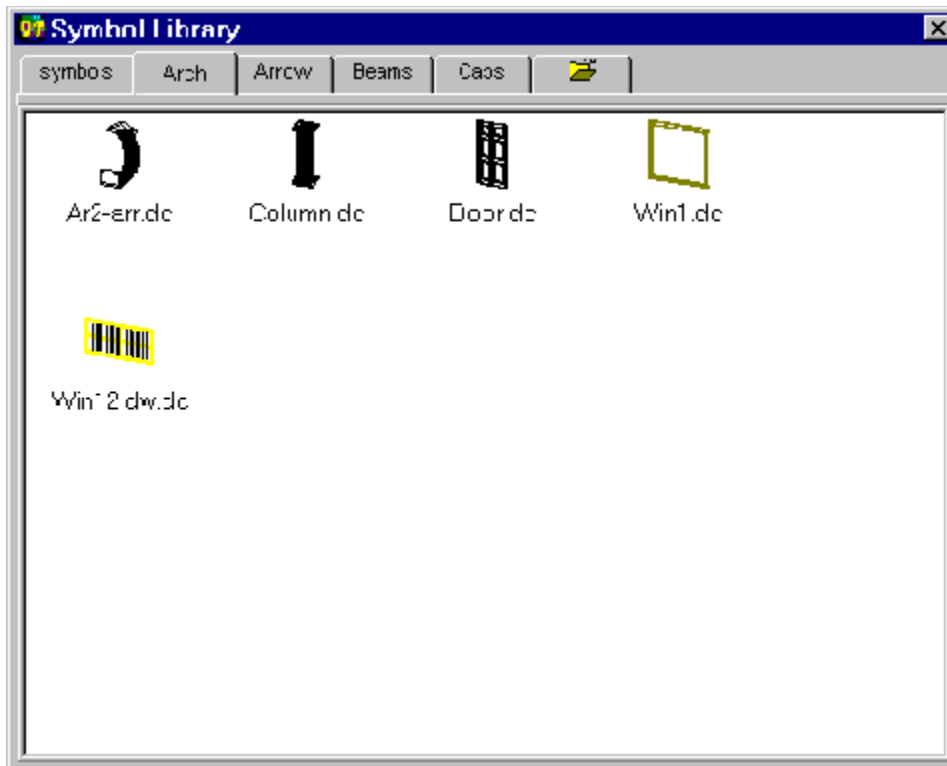

You can move the dialog box by placing the cursor on the Symbol Library title bar, pressing and holding down the left mouse button, moving the mouse, and then releasing the left mouse button. You can also resize the dialog box by moving the cursor to an edge or corner of the dialog box (the cursor will turn into a two-way arrow when you have it placed correctly), pressing and holding the left mouse button, moving the mouse to resize the dialog box, and then releasing the left mouse button. Being able to move and/or resize the dialog box simplifies the task of making the areas in which you want to place the symbols visible.

Use the scroll bar on the right side of the dialog box to scroll through the various symbols. [Click](#) the tabs or use the scroll bar at the top of the dialog box (just under the Symbol Library title bar) to view related symbols in a different library.

DesignCAD 97 allows you to view the DesignCAD 97 files contained in a directory and all of the DesignCAD 97 files in one layer of subdirectories of that directory. To view a different set of symbols click on the tab with a folder symbol on it. The Path dialog box opens. Select a new folder and click OK.

## Placing a Symbol in Your Drawing

When you find the symbol that you want to use, there are two different methods for bringing it into the drawing:

1) move the cursor over the desired symbol, press and hold the left mouse button, drag the cursor to the desired location in your drawing, position the cursor and click the mouse button to drop the symbol into the drawing;

or,

2) move the cursor over the desired symbol, double-click the left mouse button, move the cursor to the desired location in your drawing, and click the left mouse button again to drop the symbol into the drawing.

Symbols are recognized as Groups (the entire symbol is one object, if you try to manipulate part of the symbol, the entire symbol is manipulated in the same way). To manipulate the different parts of the Symbol separately, select the symbol and then choose the `GROUP EXPLODE` command from the `TOOLS` menu. This will allow you to select and manipulate different parts of the symbol.

Menu: TOOLS  
Menu Command: TEXTURE MAPPING

The Texture Mapping command copies a texture from an image file (bitmap, gif, jpeg, etc.) and applies that texture to one or more DesignCAD drawing objects. The next time the drawing is shaded using either Gouraud (Medium Quality) or Phong (Best Quality) Method in the Shading Command, all items that have been assigned a texture will be shaded accordingly. Several jpegs are included with DesignCAD 97 as sample textures and are located in the DesignCAD 97 directory.

### Using the Command

Select the object to be assigned a texture. Choose the TEXTURE MAPPING command from the TOOLS menu.

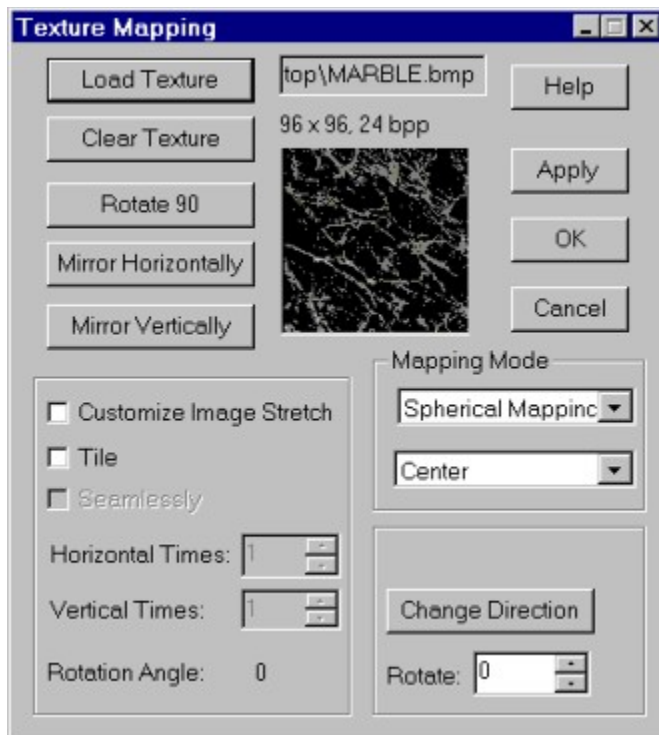

#### Load Texture

Click the LOAD TEXTURE button. The Select Texture dialog box appears. Make sure the directory that contains the image file (bitmap, jpeg, etc.) is listed in the Look In: box. Select the file from the area below the Look In: box or type the name in the FILE NAME: box. Click on the OK button.

#### Clear Texture

The Clear Texture button is used to remove all texture settings from the currently selected drawing objects.

#### Rotate 90

The Rotate 90 button may be used to rotate the image file 90 degrees for the image's use as a texture. This button can be used two times to rotate the image 180 degrees and three times to

rotate the image 270 degrees if necessary.

### **Mirror Horizontally**

The Mirror Horizontally button “flips” the image so that all portions of the image that were on the left side will now be on the right and vice versa.

### **Mirror Vertically**

The Mirror Vertically button “flips” the image so that all portions of the image that were on the top of the image will now be on the bottom and vice versa.

### **Customize Image Stretch**

This option allows for the customization of the image’s scale and aspect ratio. When the Customize Image Stretch option is selected:

- 1) 1) the Tile option is disabled, the number of copies of the image that appear on a single surface is determined by the values set for Image Scale and Aspect Ratio;
- 2) 2) the Seamlessly option is enabled and available for selection or de-selection; and
- 3) 3) the Image Scale and Aspect Ratio options are enabled so their values may be set

### **Seamlessly**

This option inverts one images everywhere two images meet in a tile, so the edges of the image copies will not be as noticeable.

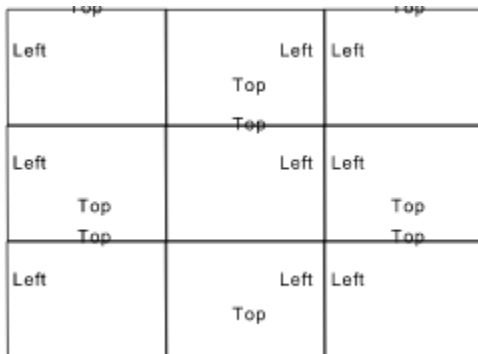

### **Image Scale**

Enter the value for the scale at which the image is to be displayed. For example, a value of .5 will display the image at half of its original size and a value of 2 will display the image at two times its original size.

### **Aspect Ratio**

Enter the value for the relationship of the vertical and horizontal scale factors at which the image is to be displayed. For example, a value of .5 will display the image so that the vertical scale is twice that of the horizontal scale, and a value of 2 will display the image so that the horizontal scale is twice that of the vertical scale.

### **Tile**

This option lets several copies (or an array) of the image appear on a single surface. When this



option is selected the Seamlessly, Horizontal Times, and Vertical Times options are enabled.

### **Seamlessly**

This option blurs the edges of the image slightly, so the edges of the image copies will not be as noticeable.

#### Horizontal Times

Enter the number of copies of the image is to be displayed from left to right on the selected item(s).

#### Vertical Times

Enter the number of copies of the image is to be displayed from top to bottom on the selected item(s).

### **Rotation Angle**

This value displays the current rotation angle of the image being used as a texture. This value can be increased or decrease by clicking the ROTATE 90 button repeatedly.

### **Mapping Mode**

There are several Mapping Modes from which to choose. The default direction for the texture runs parallel to the Y axis; this direction can be changed for some of the Mapping Modes. Each Mapping Mode has a unique set of options available in the list box directly below the Mapping Mode list box. Each Mapping Mode and option combination works best with a different kind of entity. Some experimentation may be required to determine which Mapping Mode and option works the best for different items in a given drawing.

#### **Spherical Mapping**

As its name indicates, this particular mode works best on rounded three-dimensional surfaces. Unlike most of the other Mapping Modes, Spherical Mapping mode has a single method: Center. Spherical Mapping mode takes the flat image and wraps and stretches it around the selected object. The direction for the texture determines the “poles” of the object. If the Y axis is said to run through the poles of the object, the top and bottom edges of the image are compressed to meet at these poles and is stretched to fit around the “equator” of the object.

#### **Grid Patch Mapping**

The Grid Patch mode divides the image into the number of surfaces the selected object has. Each division of the image is then assigned to a surface. This mode is recommended for items that have a flat face but have been extruded into a 3-D object or “grid.” This mode has two methods: Grid Only and Grid & Plane.

##### Grid Only

This method maps the selected texture to the “depth” or “grid” portion of the object (the portion of the object that is not the front “face”).

##### Grid & Plane

This method maps the selected texture to both the “face” and “grid” of the object.

### **Box Mapping**

The Box Mapping mode uses a bounding box to map the texture to the selected objects. The

bounding box is an invisible box that completely surrounds the selected objects. The front and back of this box run parallel to the XY plane. The left and right sides of this box run parallel to the YZ plane. The top and bottom of this box run parallel to the XZ plane.

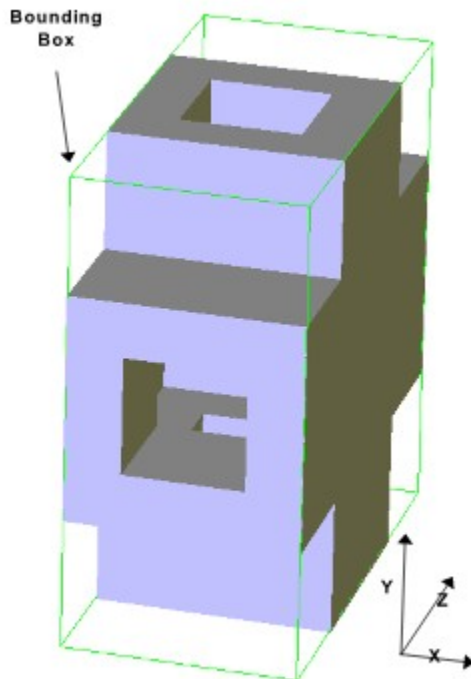

This mode has six methods. Each of these six methods corresponds to a different side of the bounding box. The texture is placed parallel to the specified side of the bounding box and then projected onto the selected object(s).

### **Cylindrical Mapping**

As its name indicates, this particular mode works best on cylindrically-shaped objects. Unlike most of the other Mapping Modes, Cylindrical Mapping mode has a single method: Center Axis. Cylindrical Mapping mode takes the flat image and wraps it around the selected object. The direction for the texture determines the “poles” of the object. If the Y axis is said to run through the “poles” of the object, the image is compressed to meet at these “poles.”

### **Plane Warp Mapping**

This Mapping Mode should only be used on plane entities. Plane Warp Mapping mode has two methods. Default method maps the entity using as much of the image as possible without causing a substantial amount of distortion, the Set Boundaries and Change Boundaries options can be used so the entire image is used. The Cutoff method trims away portions of the image so that it has the same shape as the plane to which it is to be applied.

#### **Default**

When this method is chosen, two options appear below it: Set Boundaries and Change Boundaries. The Set Boundaries option can be checked to make the entire image be used when the drawing entity is mapped. The perimeter of the plane is calculated and the points on the plane that make the most sense *mathematically* are set as the four corners for the texture. The Change Boundaries button can be used to allow four points to be set in the drawing to reset the four corners of the texture.

## Cutoff

The Cutoff method of Plane Warp Mapping trims away portions of the image so that it has the same shape as the plane to which it is to be applied. The direction of the texture may be set in the Rotate box.

Menu: ANIMATION  
Menu Command: TIME LINE

The Time Line command is a toggle that hides or shows the Animation Time Line depending on the dialog's current status.

### Using the Command

While in Animation Mode, select the TIME LINE command from the ANIMATION menu. If the Animation Time Line was visible, it will be hidden. If the Time Line was hidden, it will be made visible.

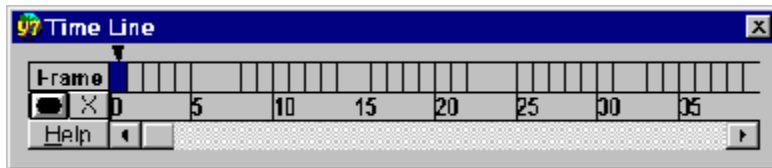

**See Also:** *Animation Mode Command, Control Panel Command*

Menu: HELP  
Menu Command: TIP OF THE DAY

The Tip of the Day command opens the Tip of the Day dialog box. In this dialog box, tips can be viewed and the Show Tips at Startup option can be enabled or disabled.

### Using the Command

Choose the TIP OF THE DAY command from the HELP menu. The Tip of the Day dialog box appears with a tip that will help you work with DesignCAD more efficiently. To view another tip click on the NEXT TIP button. Click the CLOSE button to close the Tip of the Day and return to DesignCAD.

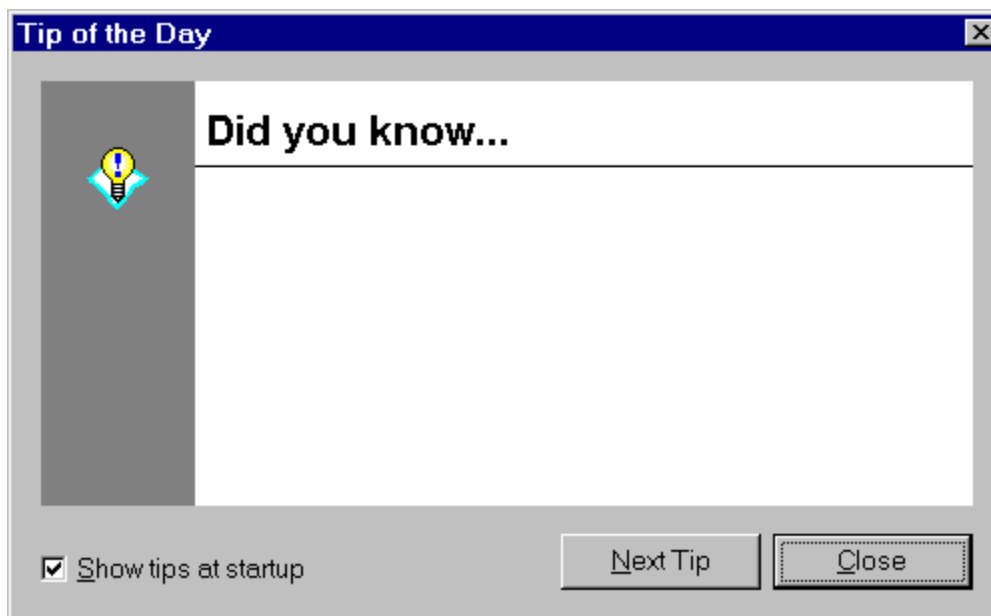

If the Show Tips at Startup option is checked, the Tip of the Day dialog box will appear when you start DesignCAD. To disable this option, uncheck the Show Tips at Startup option by clicking on the check box.

Menu: ANIMATION  
Submenu: EXPORT  
Menu Command: VRML

The VRML command exports an animation produced in DesignCAD as a VRML file so it can be used in a Web Page.

### **Using the Command**

Record an animation template or open an existing animation template using the LOAD ANIMATION TEMPLATE command in the ANIMATION menu. Create a VRML file from your template by clicking ANIMATION|EXPORT|VRML. Give the file a name, then click SAVE.

***See Also: Animation Mode Command, AVI Command, Save Animation Template, Load Animation Template***

Menu: TOOLS  
Menu Command: VRML WWW ANCHOR

The VRML WWW Anchor command lets you add a link for the World Wide Web to any non-animated VRML file.

### Using the Command

Open a file that you are going to export as a non-animated VRML file. Select the portion you want to use as a link. Select the VRML WWW ANCHOR command.

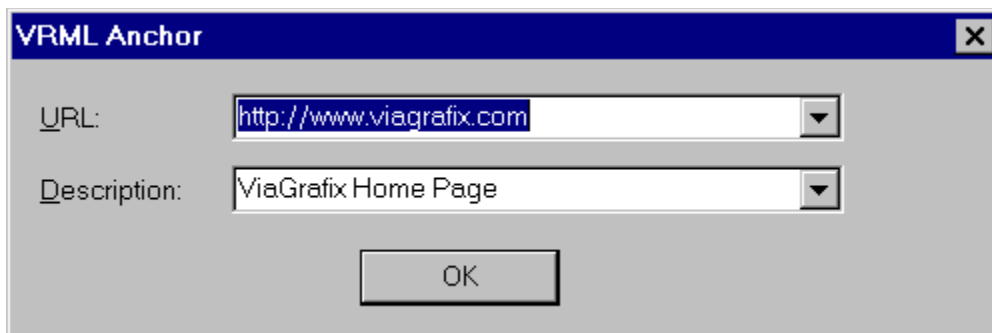

Enter the destination URL in the URL: box. In the DESCRIPTION: box, enter the description you want displayed when the user places the cursor over the graphic. Export the VRML with the EXPORT command.

Menu: EDIT  
Submenu: SELECTION  
Menu Command: WELD

The Weld command combines the area of two or more closed objects that are not solids. These objects must touch or overlap. The combined area may then be manipulated as if it had been drawn that way.

### Using the Command

Select the entities to be welded together. Choose the WELD command from the SELECTION submenu in the EDIT menu. The area of the objects is combined, and any lines that separated the objects are deleted.

### Example: Weld two shapes together.

Make sure that the closed entities to be welded together touch or overlap each other and are not solids. Select the objects. Choose the WELD command from the SELECTION submenu of the EDIT menu. The area of the entities is combined, and any lines that separated the two objects are automatically deleted.

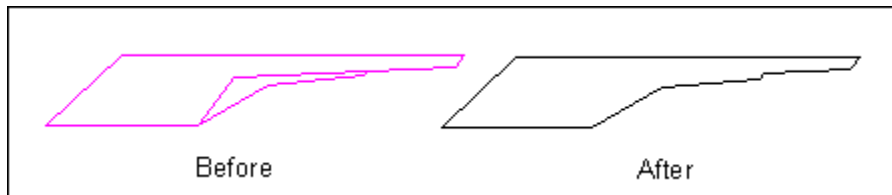



Menu: EDIT  
Menu Command: PASTE  
Shortcut Key: **Ctrl+V**

Toolbox Icon:



Point 1: First handle (lower-left-front corner)  
Point 2: Second handle (lower-right-front corner)  
Point 3: Third handle (lower-right-rear corner)

The Paste command copies drawing objects from the Windows Clipboard into DesignCAD 97.

### **Using the Command**

Choose the PASTE command. Set a point for the location of the object or group to be pasted into the drawing. If necessary, a second point can be used to specify the angle and size of the object, and a third point can be used to set the 3-D orientation.

**Example: Suppose that you want to insert an image in your drawing that you had put in clipboard.**

Select the PASTE command. A rubber-band box representing the scale of the object will follow the cursor as you move it around the screen. When you have selected a location for the copy of the object, set a point. Move the cursor to the right to stretch the scaling box. Set points for the lower-right-front and lower-right-rear handles of the copy, or press **Enter** to insert the drawing at the original scale.

**See Also: *Cut Command, Copy Command, Import Command***

Menu: DRAW  
Submenu: PLANES  
Menu Command: PERPENDICULAR PLANE

Toolbox Icon: 

Point 1: Existing line  
Point 2: Point on the line to form the center of the plane

The Perpendicular Plane command can be used to quickly create planes perpendicular to any given point on a line or curve.

### Using the Command

Choose the Perpendicular Plane command. You can set the width of the created plane in the PLANE WIDTH box in the Command Line. Set a point on the existing line. Then set a point on the line to establish the center of the plane.



### Example: Draw a 20-unit plane perpendicular to a line.

Select the PERPENDICULAR PLANE command and enter 20 for the PLANE WIDTH. Set a point near the middle of the line. DesignCAD will draw a plane of the specified width perpendicular to the line.

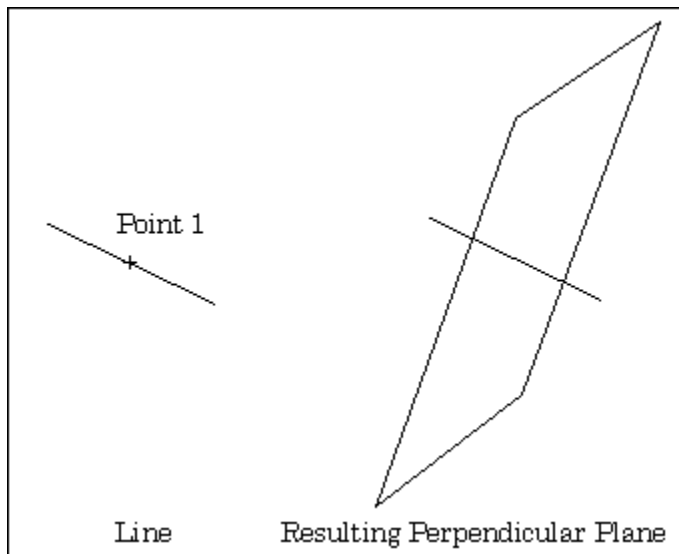

Menu: DRAW  
Submenu: LINES  
Menu Command: PERPENDICULAR TO A LINE

Toolbox Icon: 

Point 1: End point of perpendicular line  
Point 2: Point on line from which perpendicular is drawn

The Perpendicular to a Line command draws a line perpendicular from a point to an existing line.

### Using the Command

Choose the Perpendicular to a Line command. Set one point for the perpendicular location and a second point on the line to which the perpendicular line will be drawn.

This command is similar to the Perpendicular From a Line command, but the Perpendicular to a Line command uses the point away from the line for the perpendicular location. The Perpendicular From a Line command, however, uses the point on the existing line for the perpendicular location.

### Example: Draw a line from a specific point, perpendicular to a line.

Select the PERPENDICULAR TO A LINE command. Now choose a location for the endpoint of the perpendicular line and set a point there. Move the cursor to the line, and a rubber-band line will be drawn from Point 1 perpendicular to the line. Set the second point to insert the perpendicular line.

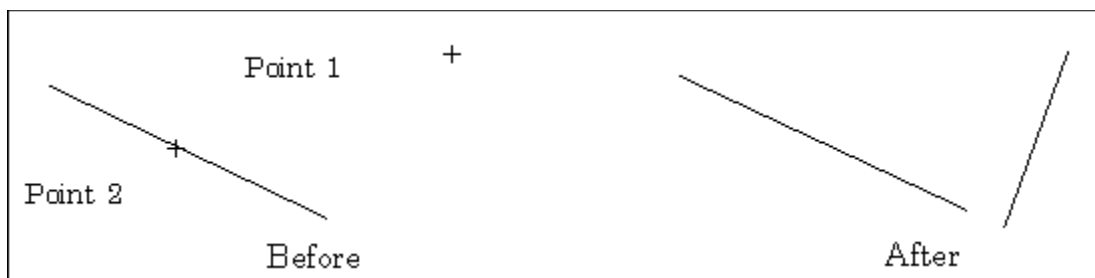

Menu: DRAW  
Submenu: LINES  
Menu Command: PERPENDICULAR FROM A LINE

Toolbox Icon: 

Point 1: Reference point  
Point 2: Direction of perpendicular

This command draws a line perpendicular from an existing line. The perpendicular line is drawn from a point on or near the existing line in the direction of the second point set. You can enter the length for the perpendicular line in the Command Line:



### Using the Command

Choose the PERPENDICULAR FROM A LINE command. Set a reference point on or near the line from which you want the perpendicular line drawn. A rubber-band line appears. Then set a second point away from the first line. A perpendicular line is drawn from the existing line through the first point in the direction of the second point.

This command is similar to the Perpendicular to a Line command, but the Perpendicular From a Line command uses the point on or near the existing line for the perpendicular location. The Perpendicular to a Line command uses the point away from the line as the reference for the perpendicular location.

### Example: Draw a 20-unit line perpendicular from a certain point on another line in your drawing.

Select the PERPENDICULAR FROM A LINE command. Enter 20 for the LENGTH in the Command Line. Set a point on or near the line, at the point through which you want the perpendicular line drawn. A rubber-band line, 20 Drawing Units in length, will be drawn from the line and through Point 1. If you move the cursor to the other side of the line, the perpendicular line will flip to the other side as well. Set the second point when the line extends in the desired direction.

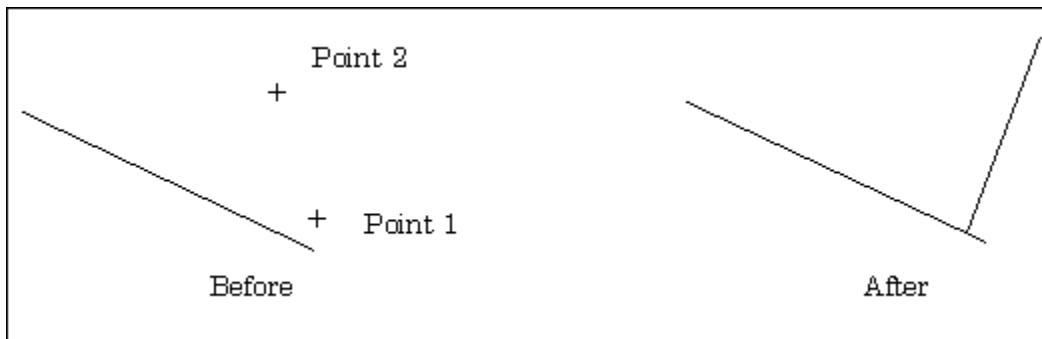

Menu: DRAW  
Submenu: PLANES  
Menu Command: PLANE  
Shortcut Key: **P**

Toolbox Icon:



Points 1-2: Starting point and edge of the plane  
Points 3-n: Points around the perimeter of the plane

The Plane command is used to draw a plane or flat surface by setting points around the perimeter of the surface. The points of a plane must lie on a single plane in 3-D space. You cannot, for example, have a plane entity with a bump in it. You can use surface commands such as Connect and Extrude for that.

### Using the Command

Choose the PLANE command. Set a starting point for the plane. Set another point for one edge of the plane, and then set at least one more unique point (i.e., not on Point 1 or Point 2) to set the plane. If you set only three points, the program automatically closes the plane for you. When you have set all the points you want, press **Enter** to end the command.

**Note:** Be careful not confuse the Plane command with the Line command. Plane entities have surface area, like a piece of paper, and can be shaded. Line entities have no surface area, like a piece of thin wire, and they cannot be shaded.

---

### Example: Create a plane along four specific points in your drawing.

Select the PLANE command. Set the points for the plane in the desired locations. Press **Enter** when you are finished. DesignCAD checks to see if the points form a valid plane. If they do not, you will have the option to allow DesignCAD to adjust the points so that they form a plane.

Menu: POINT  
Menu Command: PLANE SNAP

Toolbox Icon: 

Point 1: Point on or near the plane to which you want to snap

The Plane Snap command moves the cursor to the nearest location on the nearest surface and sets a point there.

### **Using the Command**

Choose the PLANE SNAP command and set a point near the plane you want a point on. The cursor snaps to that plane and sets a point there.

### **Example: Set a point on the nearest point of the closest plane.**

Select the PLANE SNAP command. Move the cursor near the plane and click the left mouse button. The cursor snaps to the nearest point on the plane and sets the starting point for your line there.

Menu: EDIT  
Menu Command: PLANE SUBTRACT  
Point 1: Plane to erase  
Point 2: Plane to be modified

The Plane Subtract command subtracts one plane from another. It can be used to make a hole or opening of a specific shape in a plane.

### Using the Command

Choose the PLANE SUBTRACT command. Set a point on the plane to be subtracted and a second point on the plane from which the first plane is to be subtracted. The first plane is then subtracted from the second.

If the first plane is in front of or behind the second, then the second plane will be projected onto the first for the subtraction.

**Note:** If the first plane is completely inside the second plane, then DesignCAD has to cut the second plane into two pieces to perform the subtraction. This is an unavoidable necessity of the algorithm.

---

### Example: Cut a plane with an overlapping plane.

Select the PLANE SUBTRACT command and set a point on the plane you want to subtract. Set a second point on the other plane. DesignCAD removes all of Plane 1 and the portion of Plane 2 that was overlapped.

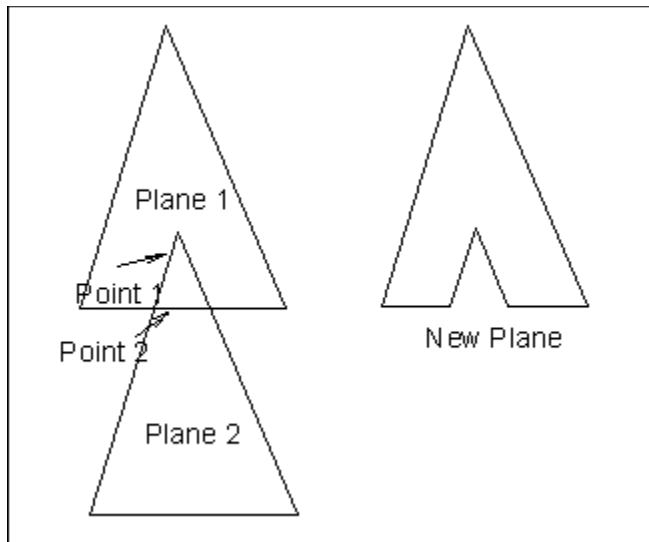

Menu: POINT  
Submenu: POINT CONTROL  
Shortcut Key: J  
Menu Command: *commandname*

The Point Control submenu contains several simple, commands. These commands can be used after the first point is set in a drawing command to insert another point relative to the first by a specified angle or distance.

### Using the Command

After selecting a drawing command and setting the first point, select POINT CONTROL from the POINT menu. A menu of simple commands appears. Choose the desired command from this listing. The movement of the cursor is restricted according to the command.

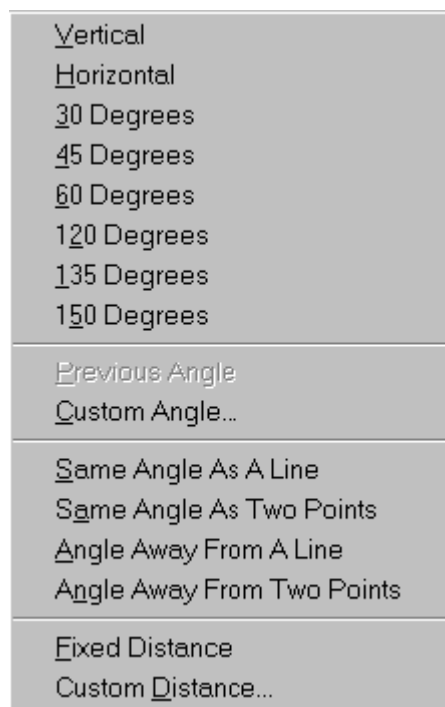

#### Vertical

This command forces the cursor to move parallel to the Y axis.

#### Horizontal

This command forces the cursor to move parallel to the X axis.

#### 30 Degrees

The 30 Degrees command restricts movement of the cursor to a 30-degree angle.



#### 45 Degrees

The 45 Degrees command restricts movement of the cursor to a 45-degree angle.

#### 60 Degrees

The 60 Degrees command restricts movement of the cursor to a 60-degree angle.

#### 120 Degrees

The 120 Degrees command restricts movement of the cursor to a 120-degree angle

#### 135 Degrees

The 135 Degrees command restricts movement of the cursor to a 135-degree angle.

#### 150 Degrees

The 150 Degrees command restricts movement of the cursor to a 150-degree angle.

#### Previous Angle

Before becoming accessible, the Previous Angle command requires that **two** points be set with one of the drawing commands. These first two points determine the angle at which the Previous Angle command sets the third point. The third point is set so that a straight line could be drawn through all three points.

#### Custom Angle

The Custom Angle command restricts cursor movement to an angle entered in the Angle Dialog Box. Leave the Release Fixed Angle on Point Set option checked to release the cursor when you set a point. Uncheck the checkbox to use the Custom Angle command for several points along the same Custom Angle.

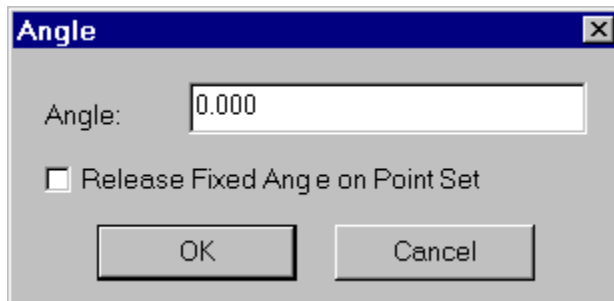

#### Same Angle as a Line

After setting the first point in a drawing command, choose this command and set a point on an existing line. The cursor is restricted to the angle defined by the line for the insertion of the second point.

#### Same Angle as Two Points

After choosing the Same Angle as Two Points command, set two points. The Same Angle as Two Points command restricts the cursor to the angle defined by these two points.

#### Angle Away from a Line

The Angle Away from a Line command lets you place a point on a line. The cursor is restricted to a specified angle away from that line. Set the desired angle in the Command Line.

#### Angle Away from Two Points

The Angle Away from Two Points command allows you to set two points that define an angle. If an imaginary line were drawn through the two points, the cursor is restricted to a specified angle away from that imaginary line. Set the desired angle in the Command Line.

#### Fixed Distance

The Fixed Distance command lets you set a point a fixed distance from the previous point. The distance used by the Fixed Distance command may be changed by using the Custom Distance command.

#### Custom Distance

The Custom Distance command lets you change the distance used in the Fixed Distance command. Uncheck the Release Fixed Distance on Point Set option if you want to set multiple points using the Fixed Distance command.

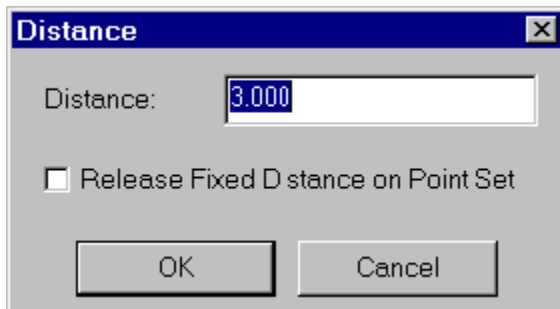

**Example: Set the second point for an arc using the Same Angle as a Line command.**

Choose the ARC (ENDPOINTS, CENTER) command. Set the first point for the arc. Choose the SAME ANGLE AS A LINE command from the POINT CONTROL submenu of the POINT menu. Set a point on the existing line that lies at the desired angle. The cursor is restricted to that angle. Set the second point for the arc. Set a third point for the radius of the arc. The angle between the two endpoints of the arc is the same as that of the line.

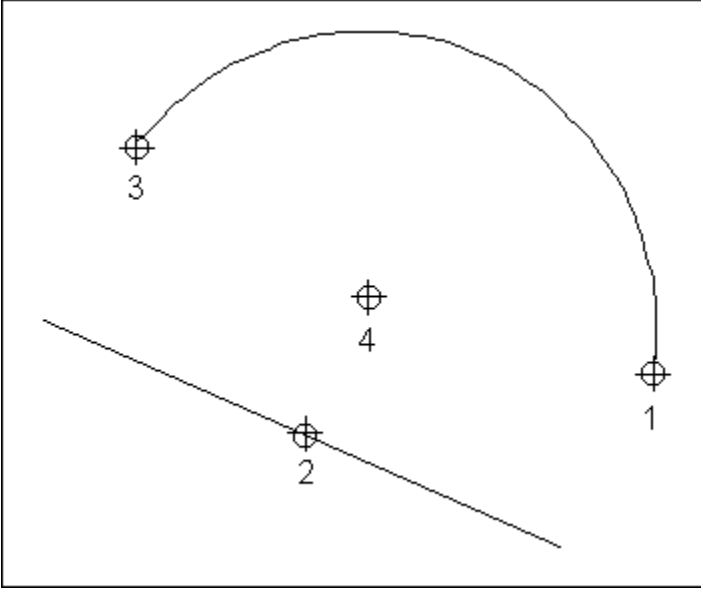

Menu: DRAW  
Menu Command: POINT-MARK

Toolbox Icon: 

Point 1: Location for point mark.

The Point-mark command marks a point in the drawing with a small cross, box, circle or combination of these elements.

### Using the Command

Choose the POINT-MARK command in the Toolbox. Select the marker style by clicking a button in the Command Line.



Enter the size in the POINT MARK SIZE box. To draw the point mark the same size as another point mark in the drawing, click the SAME AS button. Then click a point mark in the drawing. Set a point where you want the point mark. A mark is placed there.

### Example: Set a point mark on the end of a line.

Draw a line with the Line command. Choose the POINT-MARK command. Select a point mark style in the Command Line. Move the cursor to the right end of the line and set a point on the endpoint. A mark is inserted at that point.

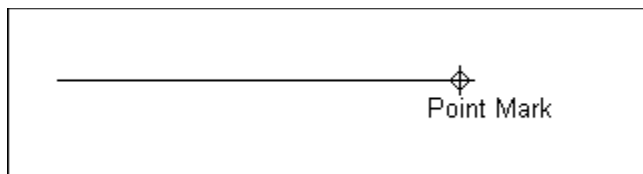

Menu: EDIT  
Menu Command: POINT MOVE  
Shortcut Key: \* (asterisk)  
Point 1: Set a point on the point to be moved  
Point 2: Set a point for the new location of that point

The Point Move command is used to move a point in the drawing.

### Using the Command

Set a point directly on another point in the drawing. The Gravity Point command can be used for this. Then set another point at the location to which the first point is to be moved. Every entity in the drawing containing the first point will be redrawn using the second point instead.

### Example: Move a corner point of a box.

Select the POINT MOVE command. Move the cursor near one of the corners of the box and click the right mouse button to set a GRAVITY point on it. Now, move the cursor to another location and set a point. The box will be redrawn with that corner in the new location. All other points of the box will remain in place.

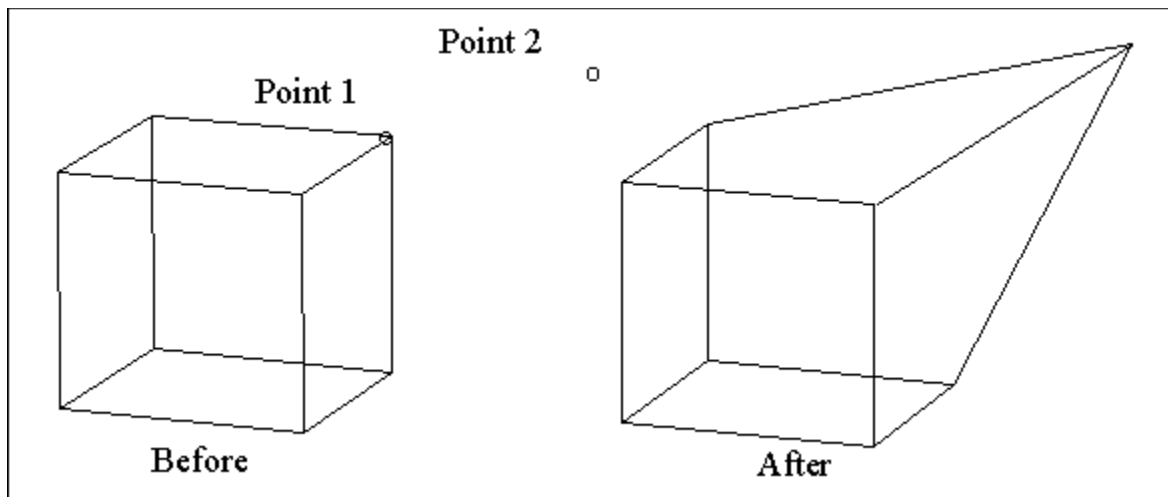

**See Also: Point Select Mode**

Menu: POINT  
Menu Command: POINT POLAR  
Shortcut Key: ; (semicolon)

This command is used to set a point by specifying the distance and angle (polar coordinates) of the new point from the last point set.

The Point Polar command is used inside another drawing command (such as Line) to set a point at a specific angle and distance from the last point set or the last cursor position.

### Using the Command

Choose the Point Polar command. In the Point Polar box enter the DISTANCE and ANGLE from the previous point.

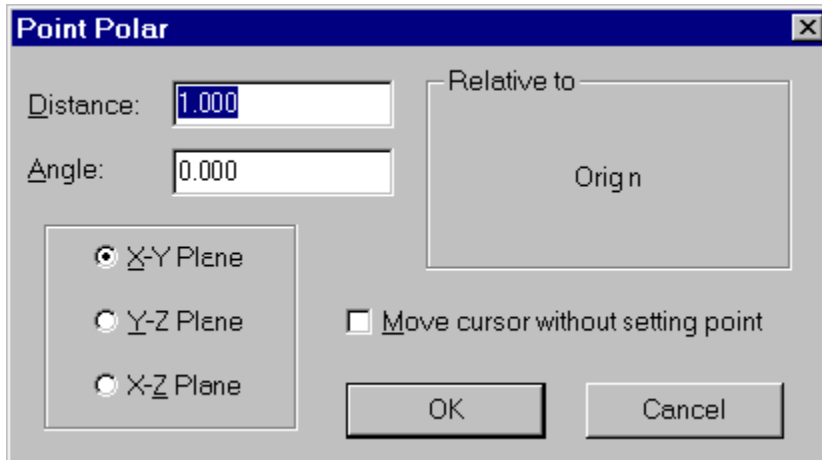

You can specify the angle in either the X-Y (horizontal-vertical), Y-Z, or X-Z plane. You can also specify whether you want the new point to be relative to the ORIGIN, LAST POINT, or LAST CURSOR POSITION by selecting the options you want.

The options available depend on how you select the command. If you move the cursor to the pull-down menu and select the command, you will not have the option of Last Cursor Position because the cursor is off the screen. The same occurs if you use the keyboard (Alt+P, then A) to activate the command. If you have set no points and you activate the command from the Command Menu, the point is placed relative to the origin. If you press the ; (semicolon) shortcut key, then you have both the Last Point and the Last Cursor Position options.

You can move the cursor to the new location without setting a point by selecting that option.

### **Example: Draw a 20-unit line in the X-Y plane at an angle of 45 degrees.**

Select the LINE command and set the first point. Then press the ; (semicolon) key to choose the POINT POLAR command. Enter **20** for DISTANCE and **45** for ANGLE in the edit boxes in the dialog box. Click the X-Y PLANE option and the LAST POINT option. Press **Enter** to execute the command. The second point of your line will be 20 Drawing Units away from the first at a 45-degree angle. Press **Enter** to insert the line into your drawing.

**See Also: General Options—Mathematical Angles, Geographical**

## ***Angles***

Menu: POINT  
Menu Command: POINT RELATIVE  
Shortcut Key: ' (single quote)

The Point Relative command is used to set a point relative to the last point set or relative to the cursor position. The position of the new point is given in horizontal (X), vertical (Y), and depth (Z) distances from the last point set. If no points have been set, the distances are calculated from the current cursor position.

### Using the Command

Choose the POINT RELATIVE command. When the Point Relative box appears, enter the X coordinate in the DX box, the Y coordinate in the DY box, and the Z coordinate in the DZ box. Normally you'll want to use the LAST CURSOR POSITION option. Click the OK button when you're satisfied with your choices.

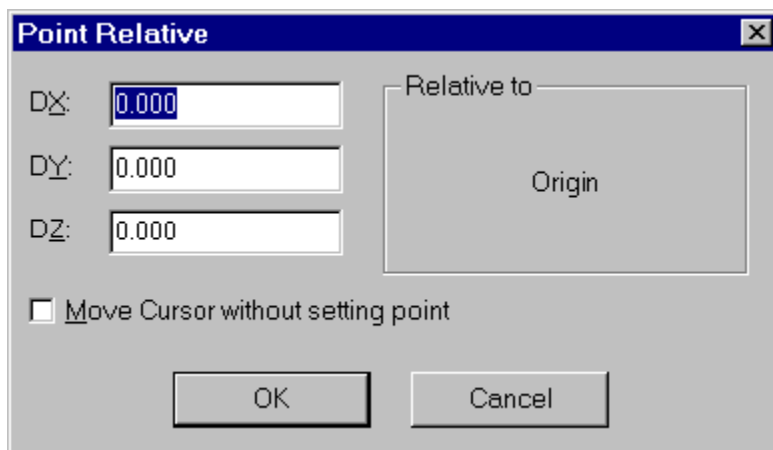

If you move the cursor to the pull-down menu and choose the command, the Last Cursor Position option will not be available because the cursor is off the screen. The same occurs if you use the keyboard (Alt+P, then R) to activate the command. If you have set no points and you activate the command from the Command Menu, the point is placed relative to the origin. If you press the ' (apostrophe) shortcut key, then both the Last Point and the Last Cursor Position options are available.

You can move the cursor to the new location without setting a point by selecting that option.

### Example: Draw a circle with a radius of exactly 10 Drawing Units.

Select the CIRCLE (CENTER, OUTSIDE) command and set a point for the center. Then press the ' (apostrophe) key to select the POINT RELATIVE command. Enter **10** in the DX box. Your circle will have a radius of exactly 10 Drawing Units.



Menu: OPTIONS  
Menu Command: POINT SELECT MODE  
Shortcut Key: **Ctrl+1**

The Point Select Mode command activates or deactivates the Point Select mode.

### Using the Command

Choose the Point Select Mode. In this mode, the individual points of an object are displayed as small boxes. You can select these points and move them individually. When Point Select mode is not active, you can only manipulate the entire object. Press **Ctrl+1** to turn the Point Select Mode on or off.

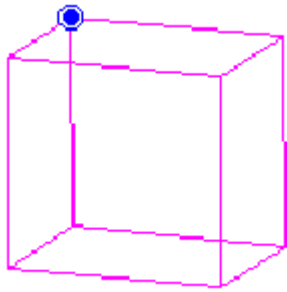

Points hidden

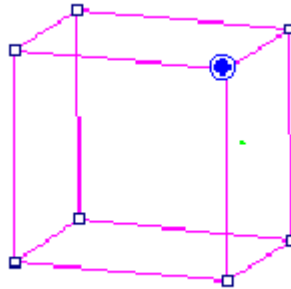

Points shown

Menu: POINTS  
Menu Command: POINT XYZ  
Shortcut Key: : (colon)

This command is used to set a point by specifying the X, Y, and Z coordinates of that point.

### Using the Command

To set a point with this command, enter the coordinates in the x, y, and z boxes and click on OK. You can also move the cursor to the new location without setting a point there by selecting that option.

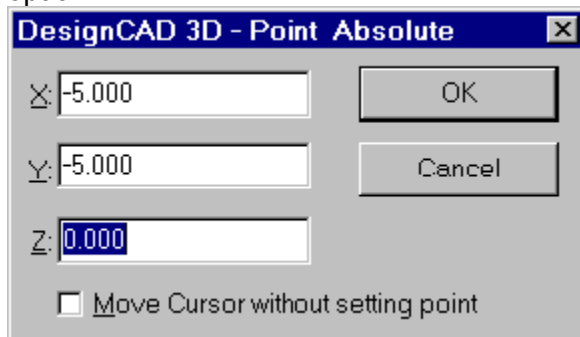



Menu: DRAW  
Submenu: PLANES  
Menu Command: POLYGON (CENTER-VERTEX)



Toolbox Icon:

Point 1: Center of the surface  
Point 2: A corner of the surface  
Point 3: An orientation point to align the surface in space

The Polygon (Center-Vertex) command draws a regular polygon—that is, a convex shape in which each side is the same length.

### Using the Command

Set two points to designate one side of the polygon. A third point can be used to determine the plane on which the polygon lies. The number of sides can be specified in the Command Line.

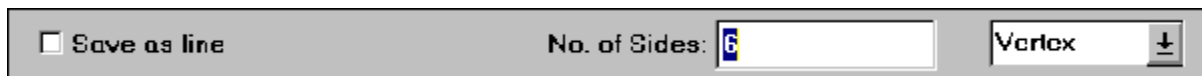

If you select SAVE AS LINE, the polygon will be saved as a line entity instead of a plane.

You can choose to draw the polygon either from center to a vertex or to the midpoint on one of the sides.

### Example: Draw a polygon with a specific center point.

Select the POLYGON (CENTER-VERTEX) command and set the first point where you want the center of the object. Set the second point the distance that you want the vertex from the center. You can set a third point to determine the plane of the polygon.

Menu: DRAW  
Submenu: PLANES  
Menu Command: POLYGON (EDGE)



Toolbox Icon:

Point 1: Start of one side of the polygon  
Point 2: End of one side of the polygon  
Point 3: Orientation of the polygon

The Polygon (Edge) command draws a regular polygon—that is, a convex shape in which each side is the same length. The number of sides can be entered in the Command Line at the top of the screen.

### Using the Command

Set two points to designate one side of the polygon. A third point can be used to determine the plane on which the polygon lies.



If you select the `SAVE AS LINE` option, the polygon will be saved as a line instead of a plane entity.

This command is similar to the Polygon (Center-Vertex) command. With the Polygon (Edge) command, you set a point on one edge of the regular polygon. With the Polygon (Center-Vertex) command, you set a point at the center and a point at a vertex of the polygon.

### Example: Draw a polygon in your drawing.

Select the `POLYGON (EDGE)` command. Set a point for the beginning of one of the sides. Then move the cursor away from Point 1. A rubber-band polygon will be drawn using the cursor position as Point 2. When the polygon is the desired size, set Point 2. Hold down **Ctrl** while moving the mouse up or down and the polygon will swing on the axis of the first two points. When the polygon lies in the desired plane, set the last point.

Menu: FILE  
Menu Command: PRINT  
Shortcut Key: **Ctrl+P**



Toolbox Icon:

The Print command outputs your drawing to a printer or plotter. The drawing is printed at the view and perspective of the current view.

### Using the Command

To print your drawing, select the PRINT command. The following dialog box comes up on the screen:

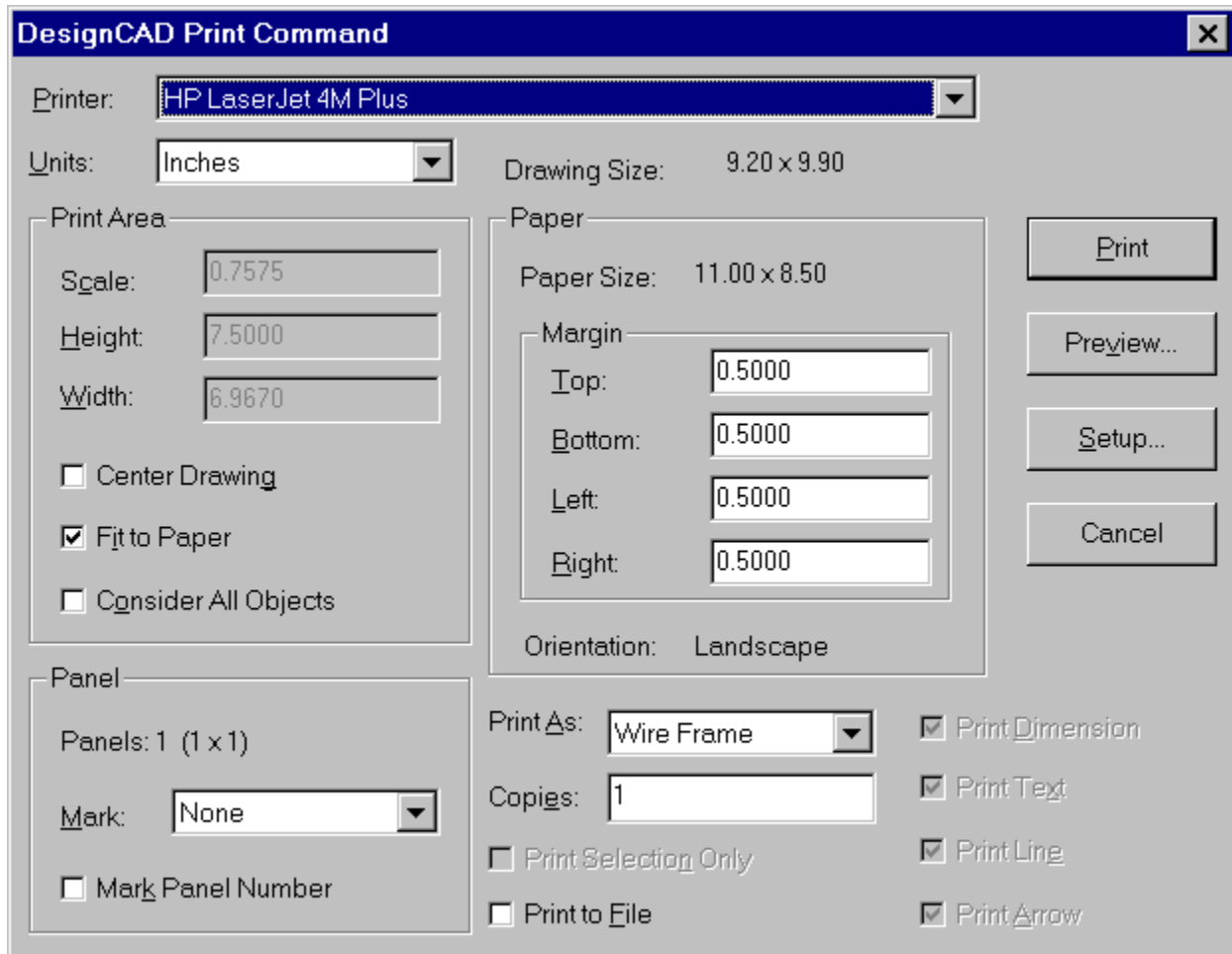

The image shows the 'DesignCAD Print Command' dialog box. It has a title bar with a close button. The main area is divided into several sections: 'Printer' (HP LaserJet 4M Plus), 'Units' (Inches), 'Drawing Size' (9.20 x 9.90), 'Print Area' (Scale: 0.7575, Height: 7.5000, Width: 6.9670), 'Paper' (Paper Size: 11.00 x 8.50, Margins: Top: 0.5000, Bottom: 0.5000, Left: 0.5000, Right: 0.5000, Orientation: Landscape), 'Panel' (Panels: 1 (1 x 1), Mark: None), 'Print As' (Wire Frame), 'Copies' (1), and a list of checkboxes for 'Print Dimension', 'Print Text', 'Print Line', 'Print Arrow', 'Print Selection Only', and 'Print to File'. On the right side, there are buttons for 'Print', 'Preview...', 'Setup...', and 'Cancel'.

### Print Options

DesignCAD offers many options, but you don't have to use them all. If you want to print your drawing on a single sheet of paper and the maximum size, just select FIT TO PAPER and click on PRINT. The other options can be used to print to scale, rotate the drawing 90 degrees, set the margins, and so forth.

## Printer

- If you have several different printers installed in Windows 95, this list box lets you select which printer to use for the current print job.

## Drawing Size

- This represents the size of the box that would just fit around the current view if the drawing were projected onto a flat surface. The size is given in DesignCAD Drawing Units.

## Units

- This is the unit of measurement for the paper on the printer. Don't confuse this item with Drawing Units. Drawing units are the units of measurement of the drawing itself, *not* the printer.

## Print Area

This group of options lets you control the size of your printed drawing.

### Scale

- This number is a ratio. It represents the number of paper units that will be used to print one drawing unit. Suppose, for example, that you are printing the front view of a 2x2 box, and you have chosen "inches" for the paper units. If you set Scale to 1.0, then one inch of paper will be used for each Drawing Unit and the box will be printed out at two inches by two inches on the paper. If you set Scale to 2.0, then two inches of paper will be used to print each Drawing Unit, and the box will be printed at four inches by four inches. With a Scale of 0.25, the box will be printed at 0.5 inches by 0.5 inches.

$$\text{Scale} = \text{Paper Units} / \text{Drawing Units}$$

### Height

- This is the height of the printed drawing on the paper if printed at the current scale. If you are printing multiple panels, this number is the total height of the drawing across all panels.

### Width

- This option reports the width of the printed drawing at the current scale. If you are printing multiple panels, this number is the overall width of the drawing once the panels are put together.

### Center Drawing

- This centers the drawing on the paper.

### Fit to Paper

- This outputs the drawing on a single page in the largest possible size. If this option is selected, the Scale, Height, and Width cannot be entered.

### Consider All Objects

- This option takes the entire drawing (including hidden layers and unselected objects) into consideration when determining the scale and center position of the printed drawing. This

provides an easy way to print transparencies.

## **Panel**

This group of options gives you information about how multiple panels will be handled. If a drawing is scaled too large to fit on a single page, DesignCAD will print the portions of the drawing on separate sheets of paper which can then be assembled. For example if a drawing were printed in four panels, then each panel would contain one-quarter of the drawing. This makes it possible to print drawings at a large scale with standard paper sizes.

Panels: 1 (1x1)

- This line displays the total number of panels to be printed, and how many across by how many down.

Mark

- You can choose whether or not to mark the boundaries of the individual panels. Your choices are NONE, CORNER MARK, and OUTLINE BOX.
  - NONE: No panel marking is done.
  - CORNER MARK: A registration mark is printed at each of the corners of the panels. This makes it easy to align the panels after printing.
  - OUTLINE BOX: Boxes are drawn around each panel to indicate margin locations. Each panel can be trimmed to the edge of these boxes so that when the panels are assembled edge-to-edge, the alignment of the panels will be correct. This way no paper overlap will interfere with the image.

Mark Panel Number

- If this box is checked, each panel will be numbered. This is useful in arranging the panels into the complete drawing.

## **Paper**

This group of options displays your paper orientation and lets you choose your margins.

Paper Size

- This displays the currently selected paper size. It can be changed by clicking the SETUP button in the Print Command dialog box.

Margin

- This option determines the size of the page margins.
  - TOP: The size of the top margin.
  - BOTTOM: The size of the bottom margin.
  - LEFT: The size of the left margin.
  - RIGHT: The size of the right margin.

Orientation

- Displays the currently selected orientation. A drawing can be printed using Portrait or

Landscape orientation. It can be changed by clicking the SETUP button in the Print Command dialog box.

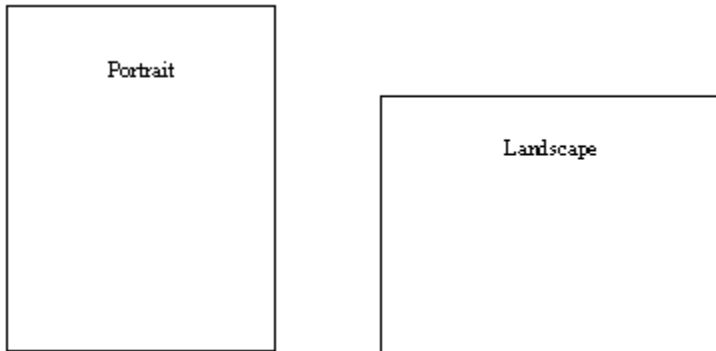

### **Print As**

- The PRINT AS option lets you print your drawing in several forms:
  - WIRE FRAME
  - QUICK SHADE
  - SMOOTH SHADE
  - HIDE (allows you to remove items from printed drawing.)
  - HIDE (PEN PLOTTER)

### **Copies**

- Enter in this box the number of copies to be printed.

### **Print Selection Only**

- If this box is checked, only the currently selected object or objects will be printed. If no objects are selected, this box is not available.

### **Print to File**

- This option can be used to send the print information to a file rather than to the actual printer. This is convenient if you need to print or plot your drawing at another location. It can also be used to transfer the drawing image to other applications.

### **Print Dimension**

- This option prints dimensions regardless of whether it is on the near side, inside, or far side of a shaded solid. This option also shows dimensions in views in which the hidden lines have been removed. This option is not available if WIREFRAME is selected in the PRINT AS list box.

### **Print Text**

- This option prints text regardless of whether it is on the near side, inside, or far side of a shaded solid. This option also shows text in views in which the hidden lines have been removed. This option is not available if WIREFRAME is selected in the PRINT AS list box.

### **Print Line**

- This option prints lines regardless of whether they are on the near side, inside, or far side of a shaded solid. This option also shows all lines in views that have the hidden lines removed. This option is not available if WIREFRAME is selected in the PRINT AS list box.

### **Print Arrow**



- This option prints arrows regardless of whether they are on the near side, inside, or far side of a shaded solid. This option also shows all arrows in views that have the hidden lines removed. This option is not available if WIREFRAME is selected in the PRINT AS list box.

## Print

- This button starts the printing process.

## Preview

- Clicking this button brings up the Print Preview screen, which shows exactly how your drawing will look on paper.

**This example shows a preview of a multi-panel drawing.**

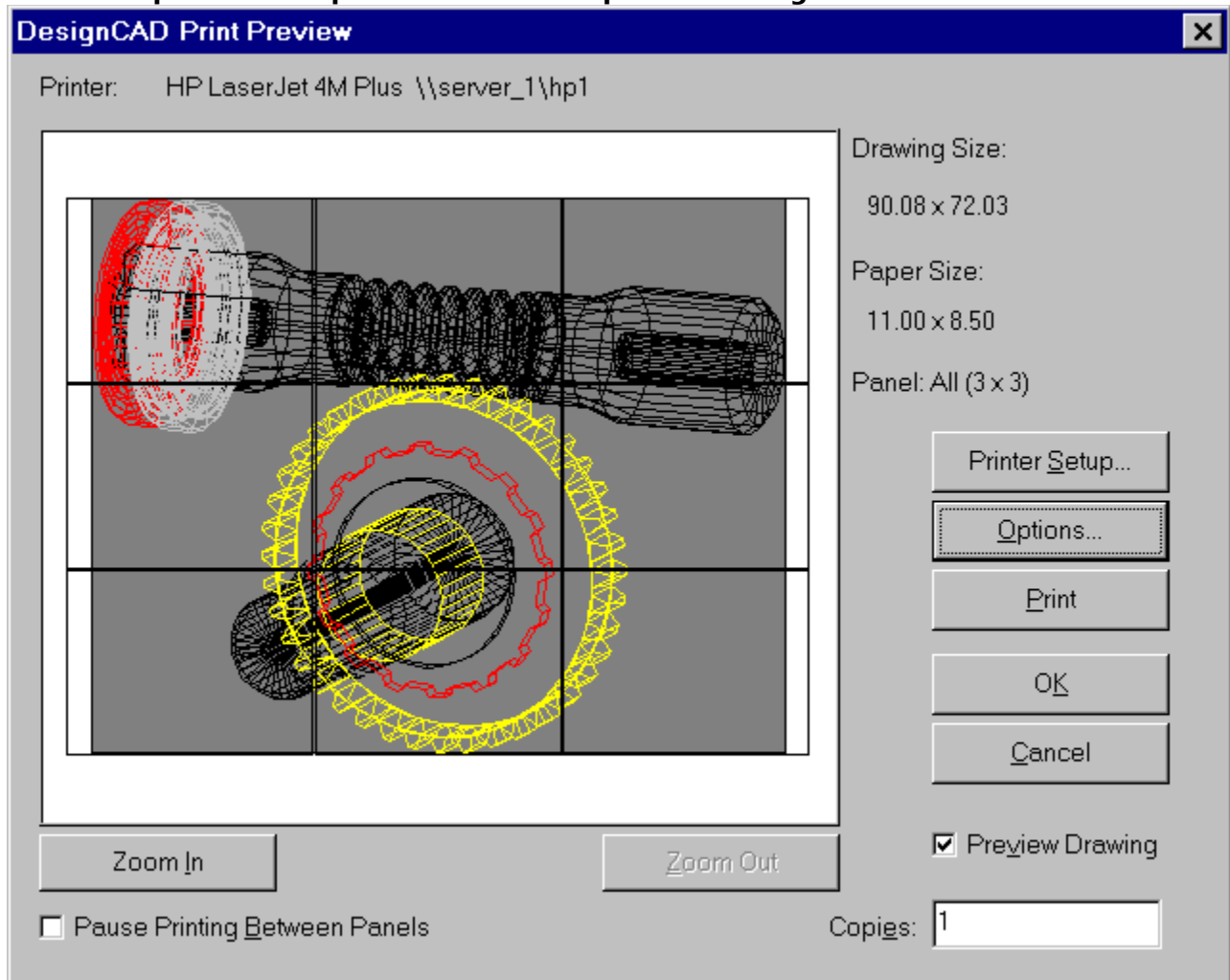

## Print Preview Options

### Printer Setup

- Brings up the Printer Setup dialog box.

### Options

- Opens a dialog box that contains many of the same options that are found in the main Print Command dialog box.

### Print

- Prints the drawing.

#### OK

- Retains any changes made to the print job while the Print Preview dialog box was open, closes the Print Preview, and returns to the Print Command box.

#### Cancel

- Closes the Print Preview and returns to the Print Command box without retaining any changes.

#### Zoom In

- Click on this button and then click on an area of the preview. The size of the area is increased to display better detail.

#### Zoom Out

- Click on this button and then click on an area of the preview. The size of the area is decreased to display more of the preview.

### **Example: Create or load a DesignCAD 97 drawing and choose the PRINT command.**

In the Print Command dialog box, click the CENTER DRAWING and FIT TO PAPER checkboxes. Select WIREFRAME in the PRINT AS list box. For this example leave the rest of the options at their defaults, but be aware that you can adjust them to your liking. Click the OK button. Your drawing will be printed on the printer currently selected in the PRINTER: list box.

Menu: DIMENSION  
Menu Command: PULLOUT

Toolbar Icon: 

Point 1: Arrowhead  
Point 2 - n: Path of arrow. The last point marks the text location.

The Pullout command inserts arrows and descriptive text into a drawing.

### Using the Command

Choose the PULLOUT command from the DIMENSION menu. Enter the text information in the Text box, and click on the arrowhead button for a choice of arrowhead styles or the “T” button for a choice of text options. Set a point for the point of the arrow, and one or more other points for the body of the arrow. The last point is the location of the text.

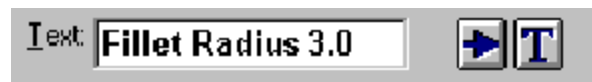

### Example: Adding a pullout to describe a fillet radius

Run the Pullout command from the Dimension menu. Enter the text “Fillet Radius 3.0” in the Text box. Set point 1 for the arrowhead, point 2 for a bend in the arrow, and point 3 for the text location. Press **Enter** to end the command.

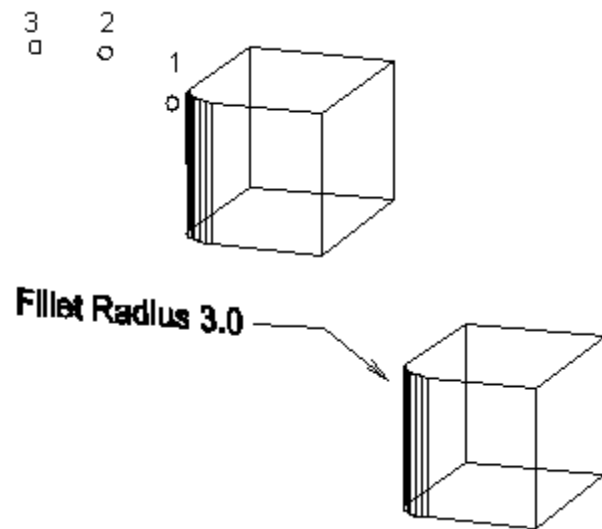

**See Also:** *Arrow Command, Balloon Command*

Menu: SOLIDS  
Menu Command: PYRAMID



Toolbox Icon:

Point 1: Center of the pyramid's base  
Point 2: Radius of the pyramid  
Point 3: Height of the pyramid

The Pyramid command draws a solid pyramid.

### Using the Command

You can specify the number of sides or facets along the longitude and the latitude of the pyramid. Enter the number of sides for the pyramid in the FACETS box in the Command Line.



You can also choose whether the midpoint or vertex of the facets will be located at the radius defined by Point 2. If you choose VERTEX, the base of the pyramid is inscribed by a circle of that radius. If you choose MIDPOINT, the base of the pyramid circumscribes a circle of that radius. This is normally not significant, but it can be important for some precision drawings.

### Example: Draw a pyramid in your drawing.

Select the PYRAMID command. Set a point for the center of the pyramid's base. Move the cursor out along the Y axis and set the second point for the radius of the base. Next, set a point for the height of the pyramid.

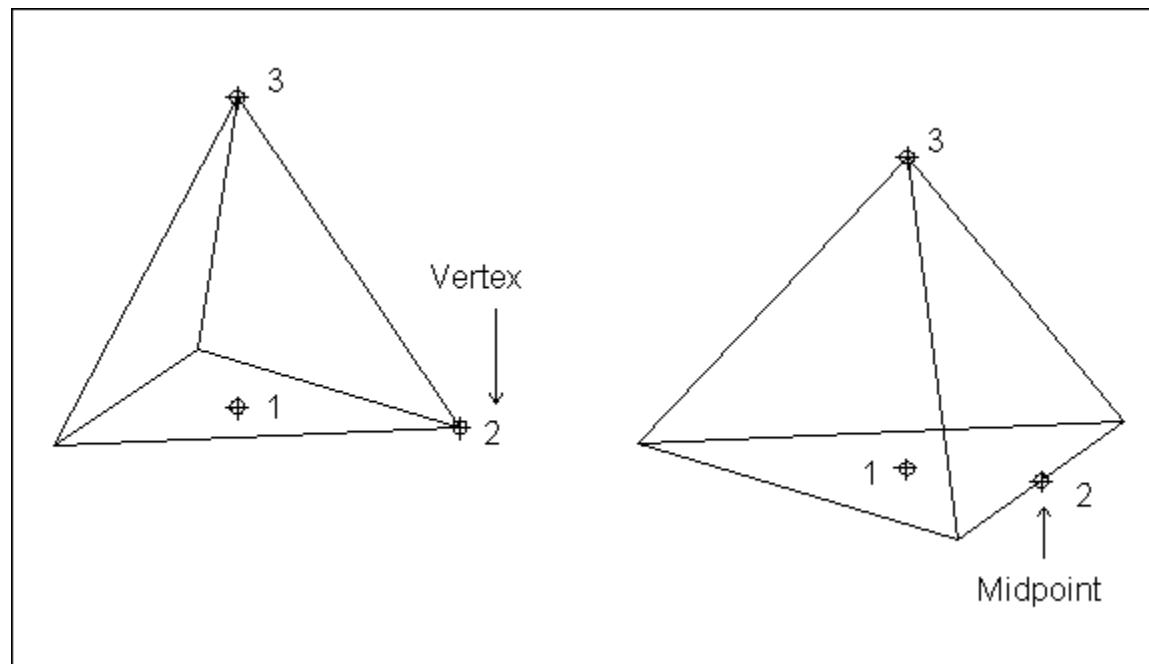



Menu: DRAW  
Submenu: ARC/ELLIPTICAL ARC  
Menu Command: QUARTER CIRCLE



Toolbox Icon:

Point 1: Beginning of the quarter circle.  
Point 2: Endpoint for the quarter circle.

The Quarter Circle command draws a quarter circle, or 90 degree arc, between two points.

### **Using the Command**

Choose the QUARTER CIRCLE command in the Toolbox. Set a point for the beginning of the quarter circle. After the first point is set, a rubber-band circle shows how the quarter circle will be drawn. Set a point for the end of the quarter circle. A quarter circle , or 90 degree arc, will be drawn counterclockwise from the first point to the second point.

Menu: EDIT  
Menu Command: REDO

Toolbar Icon: 

Shortcut Key: **Ctrl+Y**

The Redo command reverses any action performed by the Undo command. It is only available after you have used the Undo command in the current drawing session.

### **Using the Command**

Press the shortcut key, click the Toolbar icon or choose the command in the EDIT menu. The preceding action is immediately reversed.

### **Example: Replace a line accidentally erased with the Undo command.**

Select the REDO command. The line is redrawn in the same location.

***See Also: Undo Command***

Toolbox Icon:



The Refresh command refreshes the active drawing window. It cleans up images, such as cursor cross hairs, that have been left on the screen. Choose this icon when you do not want to redraw the screen but only refresh it.

### **Using the Command**

Make sure that the window to be refreshed is active. Click on the REFRESH icon. Any remnants of the cursor used in previous drawing commands are erased and blank spots caused by selection handles are restored to their former appearance.

**Note:** When working with large, detailed drawings, regenerating the entire screen takes more time than refreshing it. If you just want to clean up the effects of previous cursor locations or selection handles, use the Refresh command.

---

**See Also:** *Regenerate Command*



Menu: VIEW  
Menu Command: REGENERATE  
Shortcut Key: **Ctrl+R**

Toolbox Icon: 

The Regenerate command redraws the entire drawing in wireframe form. This erases any shaded or hidden-line areas of the screen. This command affects only the active view window.

### **Using the Command**

Choose the Regenerate command. The program immediately begins to redraw the entire drawing in wireframe form.

### **Example: Return a shaded image to wireframe format.**

Select the REGENERATE command. The object is redrawn in wireframe.

***See Also: Regenerate All Command***

Menu: VIEW  
Menu Command: REGENERATE ALL  
Shortcut Key: **Ctrl+Shift+R**

This command redraws the entire drawing in wireframe form in every open view window. It erases any shaded or hidden line areas of the screen.

### **Using the Command**

Choose the Regenerate All command. All objects on the drawing screen, in all views, are redrawn in wireframe form.

### **Example: Redraw an object in wireframe in all views.**

Select the REGENERATE ALL command. The object is redrawn in wireframe format in all views.

### ***See Also: Regenerate Command***

Menu: TOOLS  
Submenu: DIGITIZER  
Menu Command: REMOVE MENU ITEM  
Point 1: Point inside the menu area

The Remove Menu Item command removes a command from an existing digitizer menu.

### **Using the Command**

Open the digitizer menu to be changed. Choose the REMOVE MENU ITEM command from the DIGITIZER submenu of the TOOLS menu. Set a point in the area the occupied by the command you want removed. The command is removed from the digitizer menu.

***See Also: Add Menu Item Command, Close Digitizer Menu Command, Create Digitizer Menu Command, Load Digitizer Menu Command, Remove Menu Item Command***

Menu: VIEW  
Menu Command: RESET WORKING PLANE

The Reset Working Plane command reverses a Set Working Plane command. It restores the original coordinate system to the drawing, deleting any reference to the temporary coordinate axes set up by the Set Working Plane command.

### **Using the Command**

Choose the RESET WORKING PLANE command in the VIEW menu. Like the Undo command, this one reverses a previous action, in this case restoring the original coordinate system to the drawing.

***See Also: Set Working Plane Command***

Menu: WINDOW  
Submenu: DESIGNCAD TILE SETTING  
Menu Command: RESTORE DESIGNCAD TILE



Toolbox Icon:

The Restore DesignCAD Tile command changes the DesignCAD Tile setting back to its default after it has been changed with the Set As DesignCAD Tile command. The Restore DesignCAD Tile command resets the DesignCAD Tile setting to its default view configuration: the Perspective view in the large window on the right side of the screen, and the Front, Top, and Side views stacked vertically on the left.

### Using the Command

After changing the DesignCAD Tile setting with the SET AS DESIGNCAD TILE command, choose the RESTORE DESIGNCAD TILE command from the DESIGNCAD TILE SETTING submenu in the WINDOW menu. The program arranges the windows according to the default DesignCAD Tile setting with Perspective, Front, Top, and Side views.

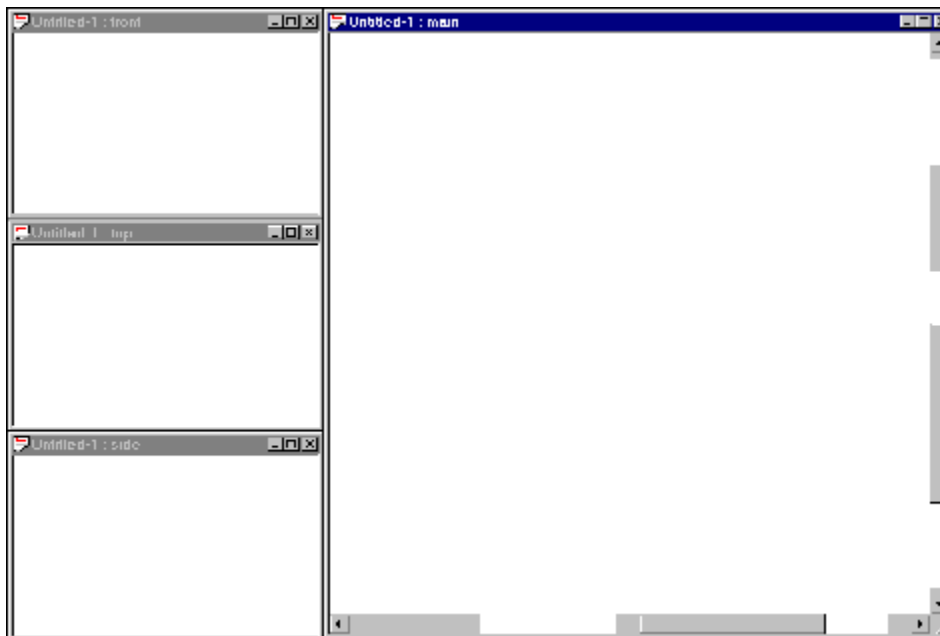

**See Also:** *DesignCAD Tile Command, Set As DesignCAD Tile Command*

Menu: EDIT  
Submenu: SELECTION  
Menu Command: ROTATE  
Shortcut Key: **R**  
Point 1: Location of rotation axis  
Point 2: Second point on rotation axis (2-Point rotation only)

This command can be used to rotate a selected object or group of objects.

### Using the Command

Select the object or object you want to rotate, and then choose the ROTATE command. The selection can be rotated on any axis at any angle. The Rotate dialog box displays several options for the axis of rotation:

X: Rotate about the selection handle on the X axis.

Y: Rotate about the selection handle on the Y axis.

Z: Rotate about the selection handle on the Z axis.

ABOUT 2 POINTS: Set two points for the axis of rotation.

ABOUT A LINE: Set a point on the line that is to be the axis of rotation.

ON A PLANE: Rotate on a plane (about the axis of plane's normal). Set a point on the plane and one for the rotation center.

ROTATION ANGLE: The value entered in this box determines how many degrees the object will be rotated if Drag Mode is not enabled.

INCREMENT: This value determines lets you restrict the possibilities for the angle at which the object may be rotated if Drag Mode is enabled. If **15** is entered for the INCREMENT value, the possible angles for the rotation are 0, 15, 30, 45, 60, etc.

DRAG MODE: This button enables/disables Drag Mode for the Rotate command. Drag Mode lets you click and hold the left mouse button in the drawing and then move the mouse/cursor to specify the direction and distance for the rotation. The distance for Drag mode can be restricted by changing the Increment value.

If Drag Mode is disabled, the value entered in the Rotation Angle box will be used to rotate the selected object(s). A point can be set away from the object to determine the point about which the object(s) will be rotated. If the **Enter** key is pressed without setting a point, the Primary Selection Handle will be used as the center of rotation.

If the Drag Mode option is enabled, the Primary Selection Handle will be used as the center of rotation.

### Example: Rotate a box 45 degrees on the Y axis.

Select a box. Choose the ROTATE command. Enter **45** in the ROTATION ANGLE field. Select the Y option for ROTATION AXIS. Press **Enter**. The box rotates 45 degrees on the Y axis.

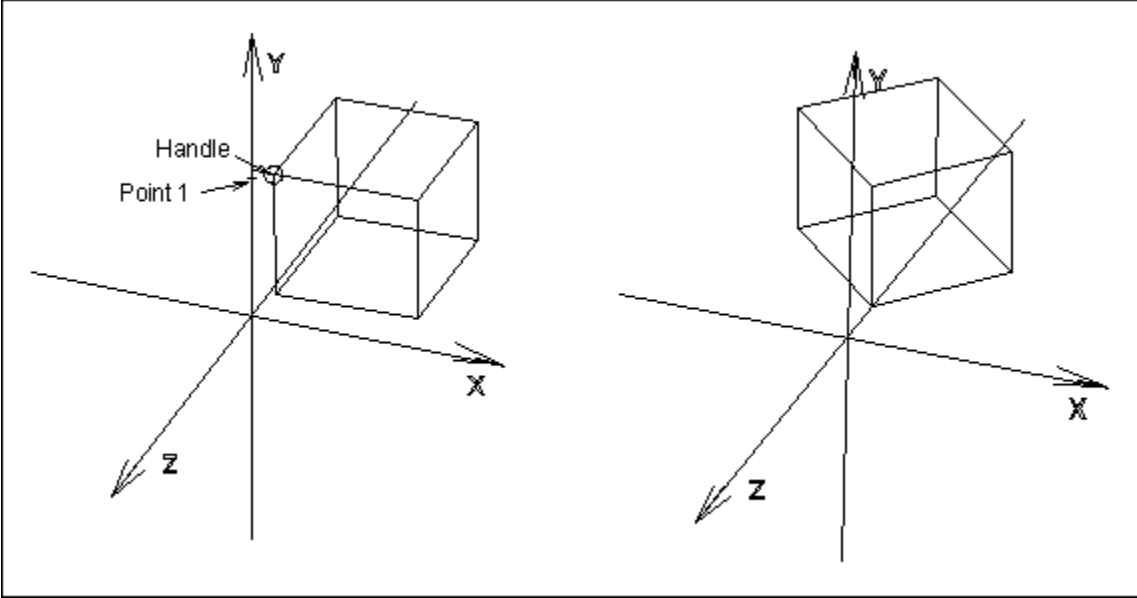

Menu: SOLIDS  
Menu Command: ROUNDED BOX



Toolbox Icon:

Point 1: First corner of the box  
Point 2: Opposite corner of the box

The Rounded Box command draws a solid box with filleted (rounded) corners and edges.

### Using the Command

Select the ROUNDED BOX command. You can specify the number of facets (or "faces") for the corners and edges and the radius of these facets. Click in the ROUND BOX FACETS: box in the Command Line and enter number of facets to be drawn for each corner and edge. In the ROUND BOX RADIUS: box and enter the radius for the rounded corners and edges.

Round Box Facet:	<input type="text" value="8"/>	Round Box Radius:	<input type="text" value="1"/>
------------------	--------------------------------	-------------------	--------------------------------

When you have entered the values for the Round Box Facets: and Round Box Radius: options press the **Enter** key. Set a point for the first corner of the rounded box. Move the cursor along the X, Y, and Z axes. A rubber-band box appears to help you determine the size of your box. When the rubber-band box is the desired size, set a second point for the opposite side of the rounded box. The rounded box is drawn at the size specified by the two points set and by the values enter for the options in the Command Line.

### Example: Draw a rounded box in your drawing.

Select the ROUNDED BOX command. Enter **8** in the ROUND BOX FACETS: box. Enter **4** in the ROUND BOX RADIUS: box. Set a point for the first corner of the rounded box. Move the cursor up and to the right of the first one, noticing the rubber-band square being drawn. When the square is the size you want, move the cursor out along the Z-axis by holding down **Ctrl+Shift** and moving the mouse up. The square turns into a 3-D box. When the rubber-band box is the desired size, set a point. A box is drawn with filleted corners and edges. Each fillet has a radius of 4 and is drawn using 8 facets.



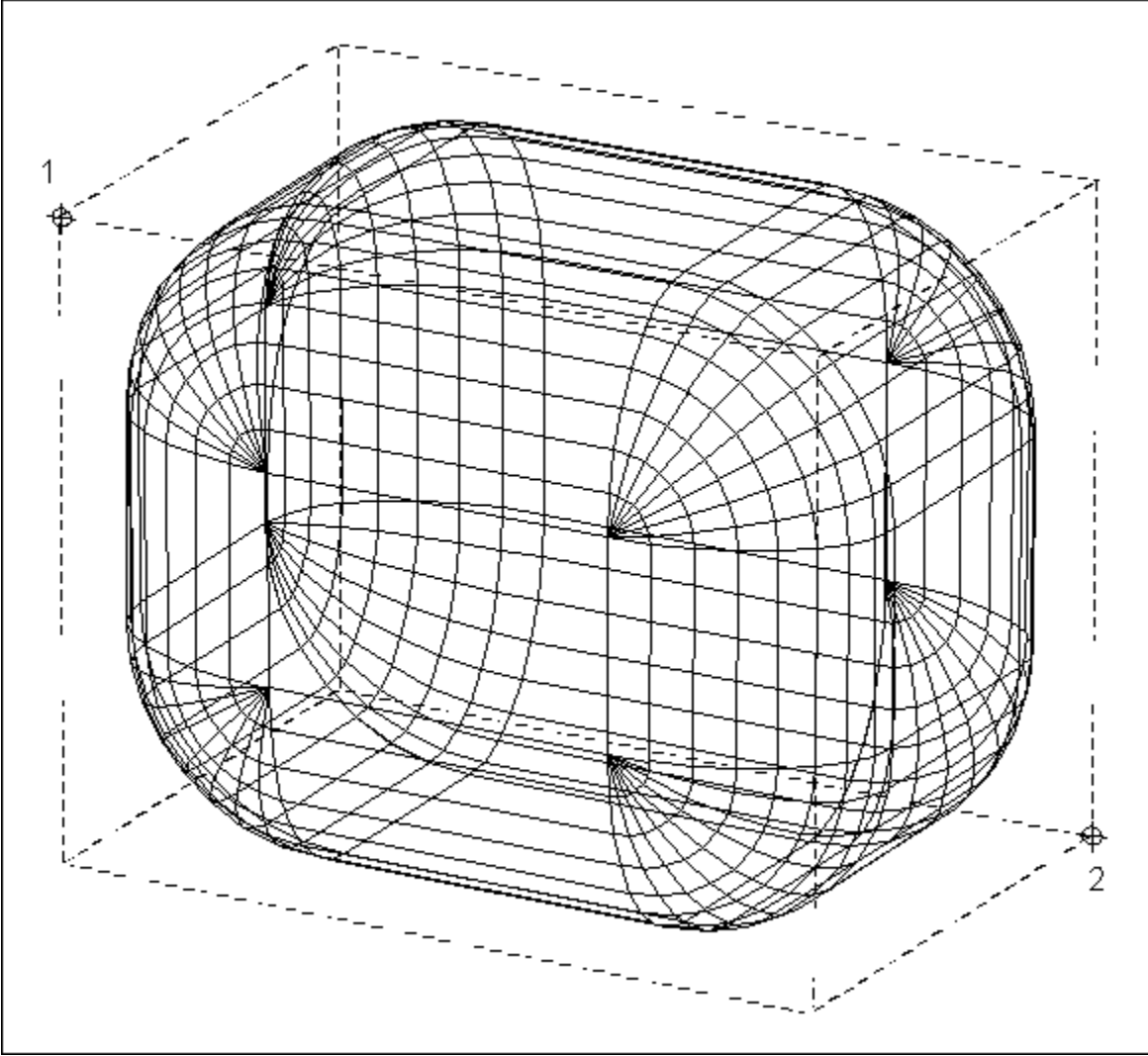

Menu: VIEW  
Menu Command: RULER

The Ruler command displays or hides vertical and horizontal rulers beside the drawing window when in 2-D Mode.

### **Using the Command**

While in 2-D Mode, choose the RULER command from the VIEW menu. This is a toggle command: select to place a check mark beside the command to turn it on; select again to remove the check mark and turn the command off.

**Hint:** You can set ruler divisions with the View Options command. To change ruler settings, choose the OPTIONS command from the OPTIONS menu and click the VIEW OPTIONS tab. Click the RULER SETTINGS button.

---

Menu: TOOLS  
Menu Command: RUN EXECUTABLE  
Shortcut Key: **Ctrl+B**

The Run Executable command lets you run an executable from within DesignCAD.

### **Using the Command**

Choose the RUN EXECUTABLE command. The Run Add-On box appears. Select or enter the name of the executable file and its location in the FILE NAME and LOOK IN boxes respectively. When you have supplied the information, click the OK button. The executable initializes.

To stop a executable, select the program's Exit command.

### **Example: Run an executable from within DesignCAD.**

Select the RUN EXECUTABLE command. Select the appropriate directory and file name in the dialog box. Click OK.

Menu: FILE  
Menu Command: SAVE  
Shortcut Key: **Ctrl+S**

Toolbox Icon: 

The Save command saves the active drawing to disk. If the drawing is new and has not yet been saved, you will be asked to name the file you want to save.

### **Using the Command**

Choose the SAVE command. If this is your first time to save the drawing, the Save As box appears. Enter the name of the file you want to save and where you want to save it. Then click OK. If you have saved the drawing before, the Save command saves all changes to the drawing since the last time you chose the Save command.

The drawing handles are automatically placed at the lower-left, lower-right, and upper-right-front of the drawing. The Set Drawing Handles command can be used to specify specific handle locations for the drawing.

***See Also:*** ***Save As Command***

Menu: FILE  
Menu Command: SAVE AS  
Shortcut Key: F12

The Save As command saves the active drawing to disk.

## Using the Command

Choose the SAVE AS command. The Save As box appears. In the File Name box enter or select the name of the file to save. In the Save In box enter the location where you want to store the drawing. If you want to save the drawing as a file type different than the one you're working in, select the type in the FILES OF TYPE box. Then click OK.

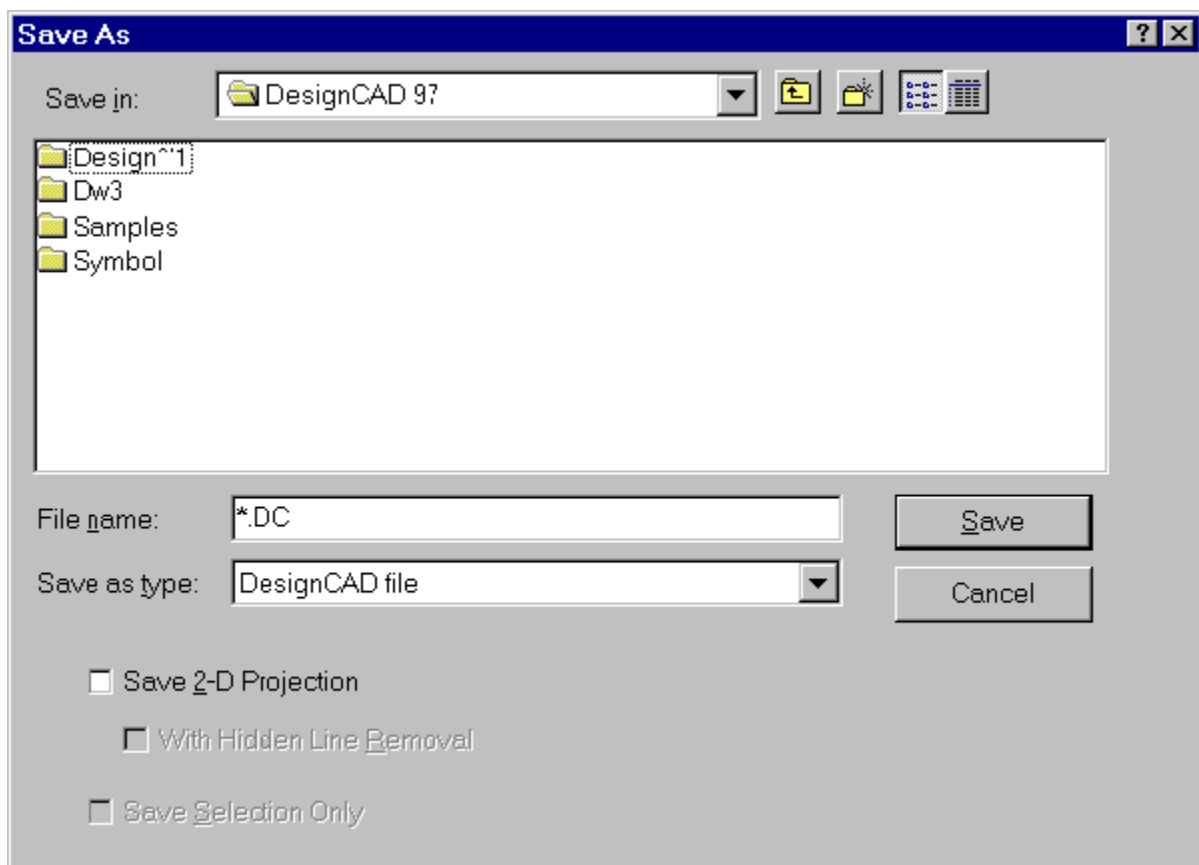

### Save 2-D Projection

- Choose this option to save your 3-D drawing as a 2-D projection, so it can be opened as a 2-D drawing.

### With Hidden Line Removal

- This option is only available if you have checked the Save 2-D Projection option. This option will remove all hidden lines from the resulting 2-D file.

### Save Selection Only

- After selecting the portion of the drawing to be saved as a separate file, select the SAVE AS command and check the SAVE SELECTION ONLY option to save the selected objects as a separate file. Be sure to change the filename for the resulting file, so you don't overwrite the original.

Menu: VIEW  
Menu Command: SAVE CURRENT VIEW

The Save Current View command saves the current view settings as a custom view selection in the Viewing Toolbox.

### Using the Command

Choose the SAVE CURRENT VIEW command. When the Save Current View box appears, enter the name of the view. The name stays in the view list until it is removed. (To remove it, click on the view name in the Viewing Toolbox and then press the **Del** key.)

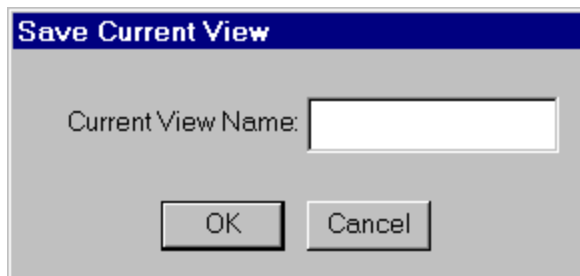

### Example: Create a drawing containing several objects.

Change the viewer position by clicking the viewer position buttons, or entering new angles in the view angle fields in the Viewing Toolbox.



When you have adjusted the view to your liking, select the SAVE CURRENT VIEW command. Enter a name for your custom view in the CURRENT VIEW NAME field and click OK. The view is saved under the selected name in the view box in the Viewing Toolbox. Next, remove the view by selecting the view and pressing the **Del** key.

Menu: TOOLS  
Submenu: DIGITIZER  
Menu Command: SAVE DIGITIZER MENU  
Point 1: Point inside the digitizer menu

The Save Digitizer Menu command saves the current digitizer menu. This command saves the menu in .DGM file format.

### **Using the Command**

After creating the digitizer menu, choose the SAVE DIGITIZER MENU command from the DIGITIZER submenu of the TOOLS menu. Set a point inside the menu area. The Save Digitizer Menu dialog box appears. Enter the name of the new digitizer menu in the FILE NAME box and click SAVE.

***See Also: Add Menu Item Command, Close Digitizer Menu Command, Create Digitizer Menu Command, Load Digitizer Menu Command, Remove Menu Item Command***



Menu: FILE

Menu Command: SAVE IMAGE FILE

Point 1: First corner of rectangular region to save

Point 2: Opposite corner of rectangular region to save

The Save Image File command saves a screen image (or part of one) as a graphics file.

### **Using the Command**

When you choose the SAVE IMAGE FILE command, a large cursor appears in the drawing window. To select a portion of the window to save in a common graphic format, set a point in two opposite corners of the region to be saved. To save the entire window as a graphics file, press **Enter** without setting any points.

The saved file can be used with other applications such as word processors and desktop publishing systems. This is a convenient way to transfer a shaded image to other applications.

Menu: EDIT  
Submenu: SELECTION  
Menu Command: SCALE  
Shortcut Key: **S**  
Point 1: Scale center

The Scale command is used to scale a selection along the X, Y, or Z axis. In other words, you can "stretch" the selected objects to make them taller, shorter, longer, wider, etc.

### Using the Command

To use the command, select the object and choose the Scale command. In the Command Line enter the scale factors for the x, y, and z directions.

Scale Factors.	X.	<input type="text" value="2"/>	Y.	<input type="text" value="2"/>	Z.	<input type="text" value="2"/>
----------------	----	--------------------------------	----	--------------------------------	----	--------------------------------

For example, to make an object twice as tall with the same width and depth, you would enter 2 for the Y scale factor and 1 for the x and z factors. When a selection is scaled, it is scaled about the selection handle.

### Example: Rescale an object so that it is twice as large along the Y axis.

Select the object and choose the SCALE command. In the Command Line enter 1 for the x and z scales, and 2 for the Y scale. Press **Enter**. The sphere is redrawn with the new scale factors.

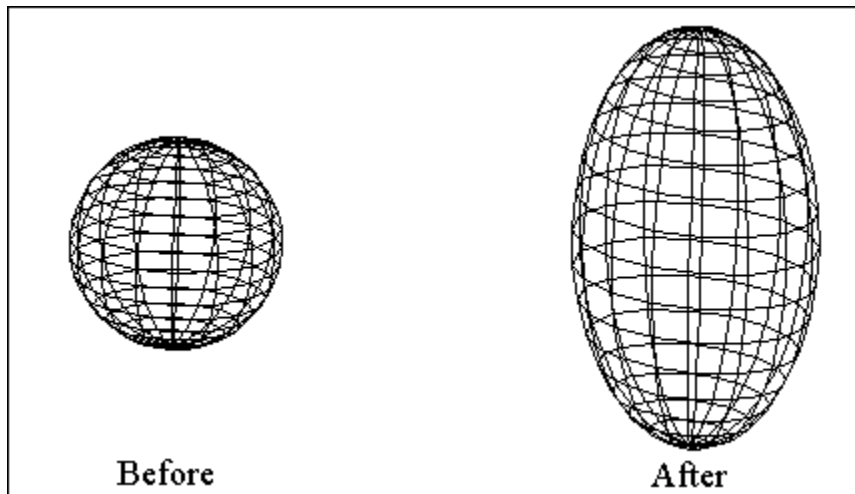

Menu: EDIT  
Submenu: SELECTION  
Menu Command: SCALE ORTHO  
Point 1: Scale center

The Scale Ortho command increases or decreases a selection's size. For example, if you set a scale factor of three, the size of the selected object triples.

### Using the Command

Select the object you want to zoom. In the Command Line enter the amount of the ZOOM FACTOR in the box. Return to the drawing screen and press **Enter**. The object is scaled.

### Example: Triple the size of a selected object.

Choose the SCALE ORTHO command. Enter **3** in the ZOOM FACTOR box in the Command Line, and then press **Enter**. The object in your drawing is redrawn, tripled in size. The rest of the drawing remains the same size.

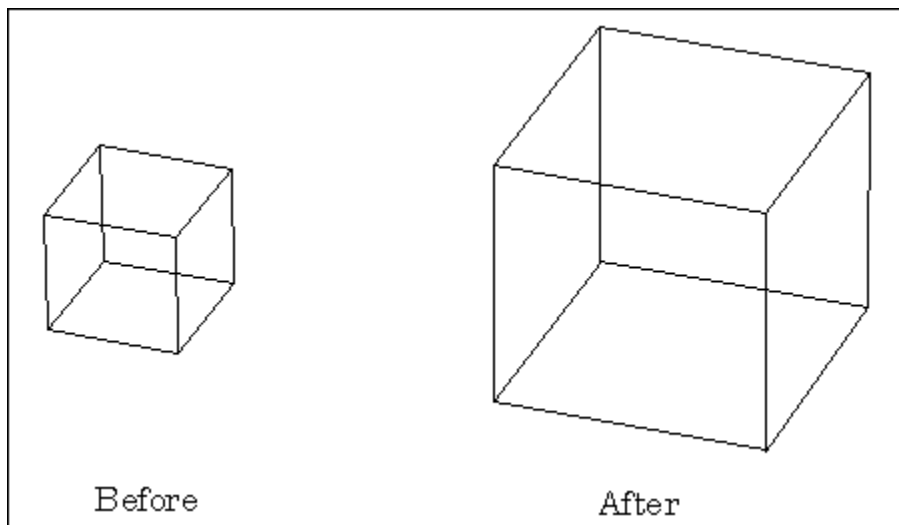

**See Also:** *Scale Command, Units Command*

Menu: FILE  
Menu Command: SCAN IMAGE

The Scan Image command gets an image from a TWAIN compatible scanner that has been specified with the Select Scanner command. A TWAIN scanner allows you to run the scanner directly from within DesignCAD. The image can later be converted into a vector image with the Auto Trace Bitmap command. This allows scanned artwork to be used in a DesignCAD drawing.

## Using the Command

Place the image in the scanner. Make sure that the scanner has been specified with the Select Scanner command. Select the SCAN IMAGE command from the FILE menu.

**Note:** Scanners vary in their capabilities and features, and this is reflected in the dialog box that appears when the Scan Image command is used. Depending on the scanner's features, it may be possible to adjust the image's orientation, the direction of the scan, the resolution, etc. Refer to the scanner's software documentation or on-line Help for more information.

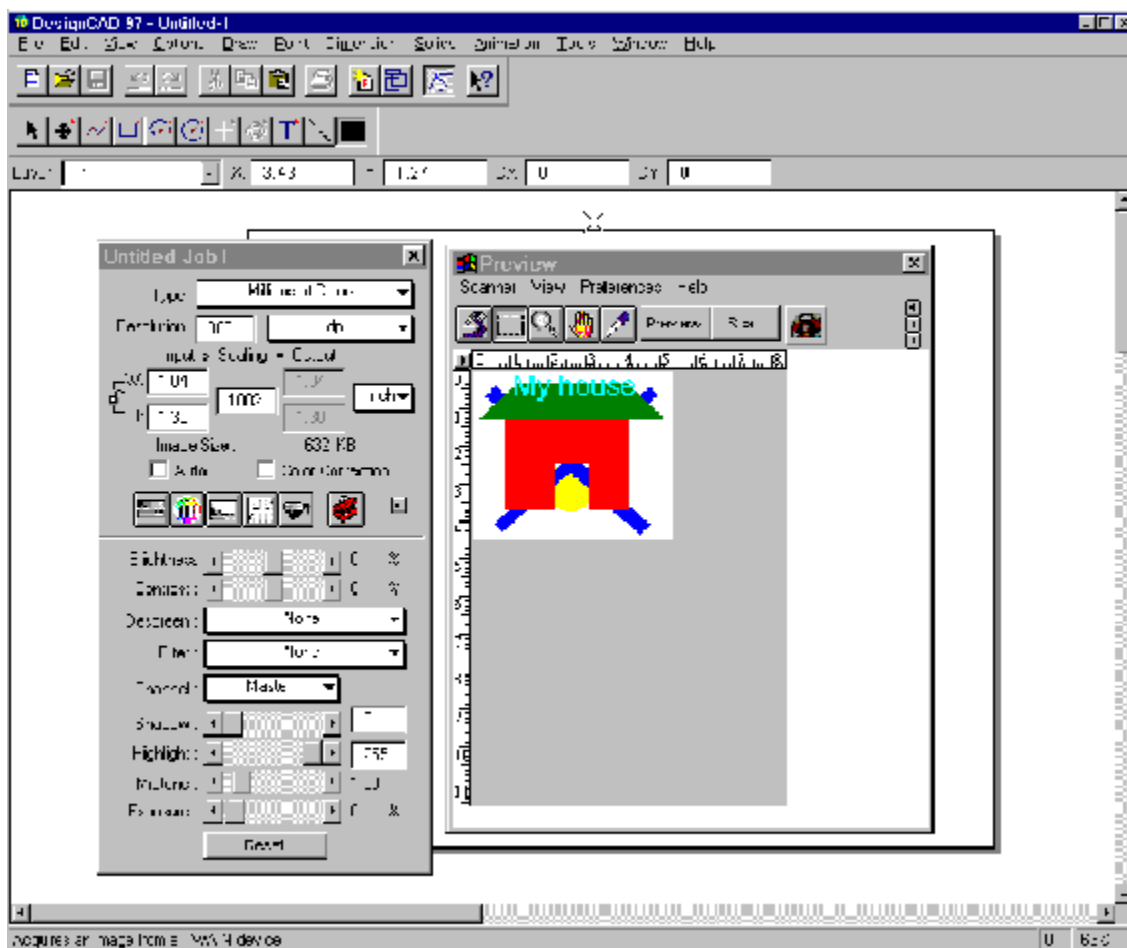

Use the scanner's own software to scan the image. The image is scanned and imported into DesignCAD. Use the Auto Trace Bitmap command in the EDIT menu to trace the bitmap as a series of vectors.

If you are using a scanner that is not TWAIN compatible, you can still use scanned images in DesignCAD, but it takes more steps to process the image. Switch to the scanner software or driver to execute the scan, then return to DesignCAD. Once the image has been scanned as a bitmap, use the LOAD IMAGE FILE command in the FILE menu to bring the image into DesignCAD. After loading the image into DesignCAD, use the AUTO TRACE BITMAP command in the EDIT menu to trace the bitmap as a series of vectors.

***See Also: Auto Trace Bitmap Command, Load Image File Command, Select Scanner Command***

Menu: FILE  
Submenu: SCREEN CONFIGURATION  
Menu Command: LOAD

This command loads a previously saved screen configuration file and applies it to the current drawing.

### **Using the Command**

Choose the SCREEN CONFIGURATION LOAD command. The OPEN VIEW FILE box appears. In the FILE NAME box enter the name of the view to load, and in the Look In box select the location of the view. Then click OK. The window configuration and view configuration for each window is loaded.

***See Also: Screen Configuration Save Command***

Menu: FILE  
Submenu: SCREEN CONFIGURATION  
Menu Command: SAVE

This command saves the screen configuration of the current drawing. The window configuration and the view configuration for each window is saved with this command.

### **Using the Command**

Choose the SCREEN CONFIGURATION SAVE command. The Save View File box appears. In the FILE NAME box enter the name of the view to save. In the STORE IN box select the location where you want to store the view. Then click OK.

This command is very useful if you have a screen configuration you use frequently.

***See Also: Screen Configuration Load Command***

Menu: EDIT  
Submenu: SECTION  
Menu Command: SECTION CUTOFF  
Point 1: One corner of the cutoff box  
Point 2: Opposite corner of the cutoff box

The Section Cutoff command cuts off a section of the drawing that intersects a three-dimensional box. It essentially separates everything inside the box from everything outside the box by cutting planes and breaking lines. Even though the drawing looks the same after the cutoff command, any entity crossing the cutoff box will be cut off.

### **Using the Command**

After choosing the SECTION CUTOFF command, define the section by setting two points in opposite corners of a three-dimensional box. Any part of the drawing that crosses the cutoff box boundary will be cut off at the intersection.

It is convenient to use this command to cut out a section of an object so it can be moved or deleted.

### **Example: Convert a circle into two separate entities.**

Select the SECTION CUTOFF command. Set the points for the cutoff box so that a section of the circle is inside the box. After the cutoff box disappears, set the cursor on the section of the circle that was inside the box and click the left mouse button to select it. Notice that only the section is highlighted. This is because it has been redefined as a separate entity. You can manipulate it using any command without affecting the rest of the circle.



Menu: EDIT  
Submenu: SECTION  
Menu Command: SECTION DELETE  
Shortcut Key: **D**  
Point 1: First corner of the section to be deleted  
Point 2: Opposite corner of the section to be deleted

The Section Delete command is used to delete or erase a section of the drawing. A section is a three-dimensional box defined by two points in opposite corners.

### Using the Command

Choose the SECTION DELETE command. Define the section by setting two points in opposite corners of a three-dimensional box. Drawing entities within the section are deleted from the drawing. An entity partly inside the box is cut off, and only the part inside the box is erased.

**Hint:** This command is useful for cutting doorways and windows out of walls.

---

### Example: Erase a rectangular section of a cylinder.

Select the SECTION CUTOFF command. Set the points of the bounding box so that part of the cylinder is enclosed in it. The cylinder will be redrawn without the section that was inside the bounding box.

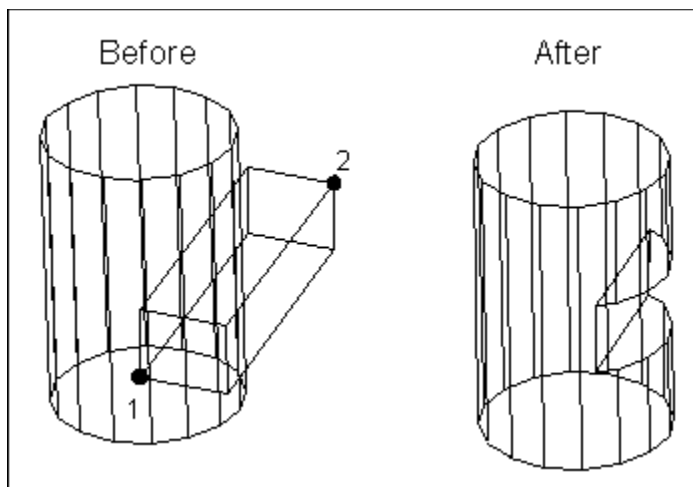

**See Also:** *Section Cutoff Command*

Menu: EDIT  
Menu Command: SEGMENT  
Point 1: Line or curve to be segmented

The Segment command allows you to divide a line or curve into a specified number of segments of equal length. Curves will automatically be subjected to Vector Convert before being segmented.

### Using the Command

Choose the SEGMENT command from the EDIT menu. In the Command Line specify the NO. OF SECTIONS you want. Set a point on the line or curve to be segmented. The object is broken into the requested number of sections.

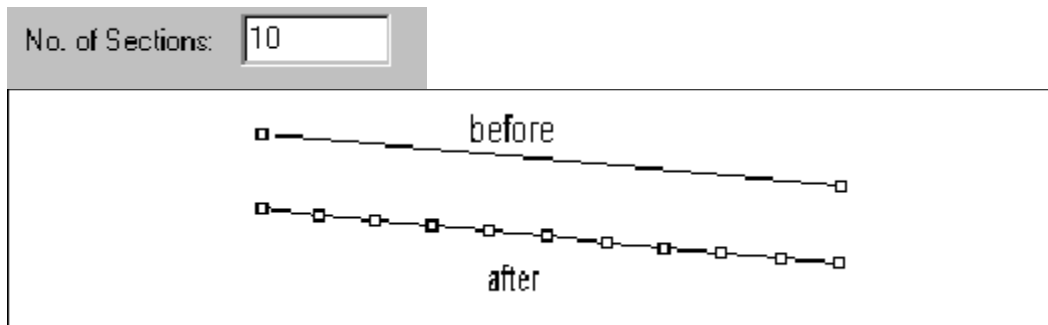

**See Also:** *Vector Convert*

Menu: EDIT  
Menu Command: SELECT ALL  
Shortcut Key: **Ctrl+A**

The Select All command selects every object in the drawing. This makes it easy to manipulate all objects as a group rather than having to perform the same command on every object individually.

### **Using the Command**

Choose the **Select All** command. Every entity in the drawing is automatically selected.

**Hint:** If you have a number of objects on the screen and need to select all but a few of them, choose the SELECT ALL command to select them all. Then depress the **Shift** key and click on the objects you don't want to be selected. This is much faster than selecting each object individually.

---

**See Also:** *2-D Selection Mode, 3-D Selection Mode*

Menu: EDIT  
Submenu: SELECTION  
Menu Command: ZOOM

The Selection Zoom command zooms, or scales, selected entities to be larger or smaller. It is similar to the Selection Scale command, but it changes both the X and Y scales the same amount. This keeps the proportions of the object intact.

### Using the Command

Select the object to be zoomed. Choose SELECTION ZOOM from the SELECTION submenu in the EDIT menu. Enter the Zoom Factor in the ZOOM FACTOR box in the Command Line. Press the **Enter** key. The object will be redrawn to the new Zoom Factor.

### Example: Zoom a Circle.

Select the circle to be zoomed. Choose SELECTION ZOOM from the SELECTION submenu in the EDIT menu. Enter **2** in the ZOOM FACTOR box in the Command Line. The circle will be enlarged to twice its original size.

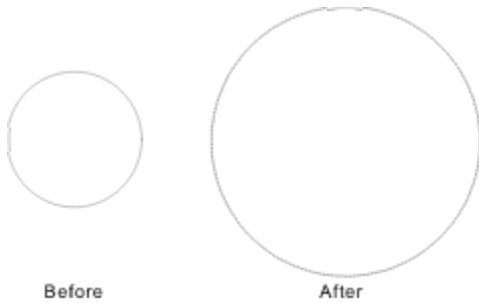

Menu: EDIT  
Menu Command: SELECT PREVIOUS  
Shortcut Key: **Shift+P**

The Select Previous command selects the entities that were previously selected in the drawing.

### **Using the Command**

Choose SELECT PREVIOUS from the EDIT menu. The entities previously selected in the drawing will be selected.

### **Example: Reselect several entities.**

Select several entities and then deselect them by pressing **Esc**. Choose the SELECT PREVIOUS command. The previously selected entities will be re-selected.

Menu: FILE  
Menu Command: SELECT SCANNER

The Select Scanner command selects the scanner for use with the Scan Image Command.

### **Using the Command**

Choose the SELECT SCANNER command from the FILE menu. Select the correct scanner for use with the Scan Image command from the dialog box.

***See Also: Scan Image Command***

Menu: DRAW  
Submenu: ARC/ELLIPTICAL ARC  
Menu Command: SEMI CIRCLE



Toolbox Icon:

Point 1: Beginning of the semicircle  
Point 2: Endpoint of the semicircle

The Semi Circle command draws a semicircle, or 180 degree arc, between two points.

### Using the Command

Choose the SEMI CIRCLE command in the Toolbox. Set a point for the beginning of the semicircle. After the first point is set, a rubber-band circle shows how the semicircle will be drawn. Set a point for the end of the semicircle. A semicircle will be drawn counterclockwise from the first point to the second point.

### Example: Draw a semicircle with a diameter of 5 units.

Choose the SEMI CIRCLE command in the Toolbox. Set a point for the beginning of the semicircle. After the first point is set, a rubber-band circle shows how the semicircle will be drawn. Set a point for the end of the semicircle 5 units from the first. A semicircle with a diameter of 5 units will be drawn counterclockwise from the first point to the second point.

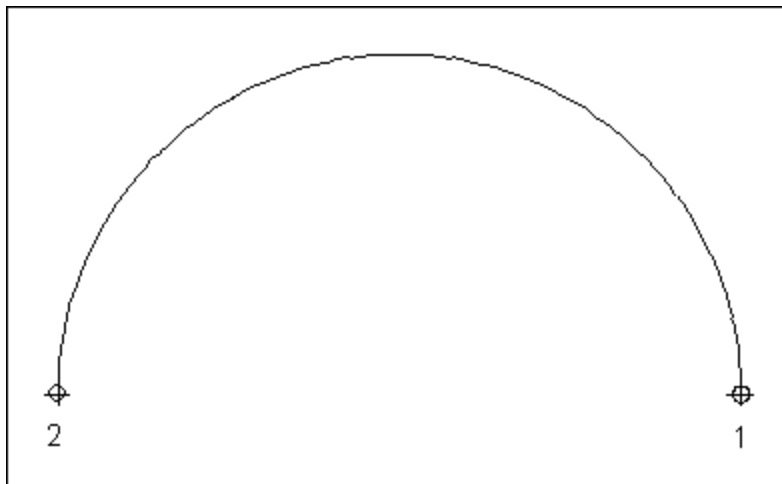

Menu: WINDOW  
Submenu: DESIGNCAD TILE SETTING  
Menu Command: SET AS DESIGNCAD TILE

The Set As DesignCAD Tile command changes the DesignCAD Tile setting to the current view configuration.

### **Using the Command**

After rearranging the view windows, choose the SET AS DESIGNCAD TILE command from the DESIGNCAD TILE SETTING submenu in the WINDOW menu. The DesignCAD Tile setting is set to the current view configuration.

**Note:** The DesignCAD Tile settings for 2-D Mode and 3-D Mode are stored as different settings; therefore, changes made to the DesignCAD Tile setting while in 2-D Mode will not affect the DesignCAD Tile setting for 3-D Mode, and vice versa.

---

The Restore DesignCAD Tile command resets the DesignCAD Tile setting to its default view configuration: the Perspective view in the large window on the right side of the screen, and the Front, Top, and Side views stacked vertically on the left.

### **Example: Reverse the default DesignCAD Tile setting**

To move a view window, click in the title bar for the view to be moved. While holding the mouse button down, drag the window to its new position. To "drop" the window, release the mouse button. Move the Front, Top, and Side views from the left side of the screen to the right. Move the Perspective view from the right side of the screen to the left. Select the SET AS DESIGNCAD TILE command from the DESIGNCAD TILE SETTING submenu in the WINDOW menu. Until the DesignCAD Tile setting is changed again using the Set As DesignCAD Tile command or the Restore DesignCAD Tile command, this is the view configuration that will be used every time the DesignCAD Tile command is selected.



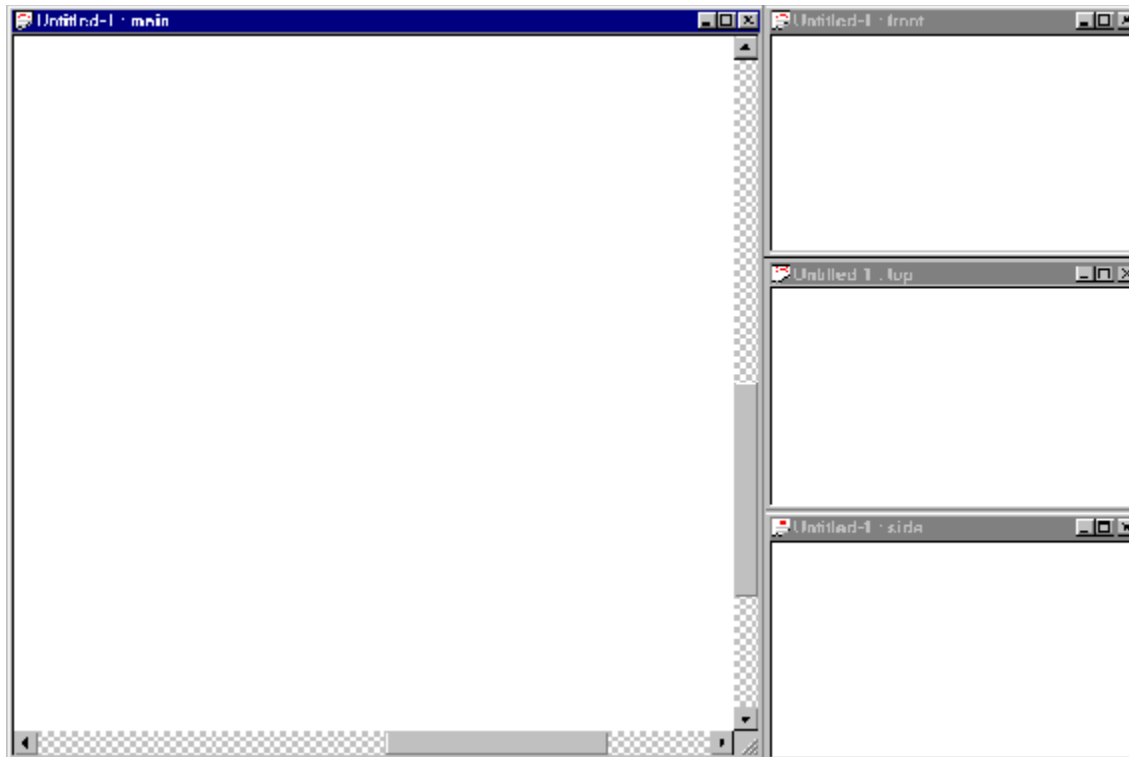

**See Also: *DesignCAD Tile Command, Restore DesignCAD Tile Command***

Menu: POINT  
Menu Command: SET DRAWING HANDLES  
Point 1: First handle  
Point 2: Second handle (optional)  
Point 3: Third handle (optional)

The Set Drawing Handles command sets handles for the drawing. Use the handles to help you manipulate a drawing when you merge it with a new or existing drawing using the Load Symbol command.

### **Using the Command**

Select the SET DRAWING HANDLES command in the POINT menu. Set one to three points in the drawing for the selection handles. If you set less than three points, press **Enter** to end the command.

Next, choose the SAVE AS command in the FILE menu. The SAVE AS dialog box appears. Rename the file or save it with the same name, then click the OK button. If you keep the same name, you are asked if you want to replace the existing file. Click OK.

The drawing is saved with the handles in place. The next time you merge the drawing into another one using the Load Symbol command, you can position the drawing using the handles you have set.

### **Example: Attach a drawing of a wing to a fuselage in another drawing.**

Open the drawing of the wing. Choose the SET DRAWING HANDLES command. Set two points at the base of the wing, where it will connect to the fuselage. Press **Enter**.

Next, choose the SAVE AS command. Rename the file as **SETWING.DC** and click OK. When you merge the wing into the drawing of the fuselage using the Load Symbol command, you can attach the wing precisely using the handles you have set and the Gravity command.

***See Also: Load Symbol Command, Save As Command, Set Handles Command***

Menu: EDIT  
Submenu: SELECTION  
Menu Command: SET HANDLES  
Shortcut Key: **Ctrl+H**  
Point 1: First handle  
Point 2: Second handle (optional)  
Point 3: Third handle (optional)

The Set Handles command can be used to set selection handles. Selection Handles are reference points for one or more entities that have been selected. The selection handles are used to help you move, copy, or manipulate the selection.

### **Using the Command**

Select the object on which you want to set the handles. Choose the Set Handles command. Set from one to three handles on the object. Press Enter to end the command if you set one or two handles. Now you can manipulate the object using the handles.

For example, when you copy an object with the Duplicate command, the first selection handle is located at the destination point you set. If you place the selection handle at a convenient location, it can be much easier to make position the copy.

The second selection handle is used with some commands to set the size and angle of a selection. The Section Duplicate and Section Move commands use the second handle.

The third handle is sometimes used to position the selection in 3-D space. For example, the Move command locates the first two handles on the first two points set, and then rotates the selection so that the three handles lie on the same plane as the three points set.

### **Example: Set handles on a box and move it.**

Select the box. Choose the SET HANDLES command. Set the first handle on the upper-right corner, the second on the lower-left corner, and the third on the lower-left-rear corner. Next, choose the MOVE command. Move the cursor to the desired new location for the box and set a point for the first handle. Move the cursor away from the first point. A rubber-band scaling box is drawn using the cursor location as Point 2. When you have scaled the object to your liking, set the second handle. Set a point for the third handle to orient the object in 3-D space.

Menu:                    OPTIONS  
Menu Command:    SET GRID CENTER  
Point 1:   Set a point for the display grid center

The Set Grid Center command sets the location for the center of the display grid.

### **Using the Command**

Choose the SET GRID CENTER command. Set a point anywhere on the drawing screen to specify the new center of the grid.

The display grid can be oriented on the X-Y, X-Z, or Y-Z plane. Its size, orientation, and spacing can be set in the GRID OPTIONS folder.

***See Also:   Grid Options***

Menu: VIEW  
Menu Command: SET VIEW  
Shortcut Key: Y

Toolbox Icon: 

The Set View command is used to change the viewer location.

### Using the Command

Select the SET VIEW command and move the cursor to the view window. Drag the cursor across the screen with the mouse. The view changes as you drag the mouse. To preview the drawing at a view position, release the mouse button. Press **Enter** when you have the desired view.

You can change the perspective of the view by moving the cursor in and out on the Z axis (by pressing **Ctrl+Shift** and moving the mouse). The Set View command can be undone with the Zoom Previous command.

### Example: See how your drawing looks from several different view angles.

Select the SET VIEW command. The cursor turns into a camera. Hold down the left mouse button while moving the mouse to set the view position. To see how the drawing looks in the new view, let go of the mouse button. If the view needs further adjustment, hold down the left mouse button and move the mouse again. When the view is set to your liking, click OK in the Command Line. To return to the original view, click CANCEL.

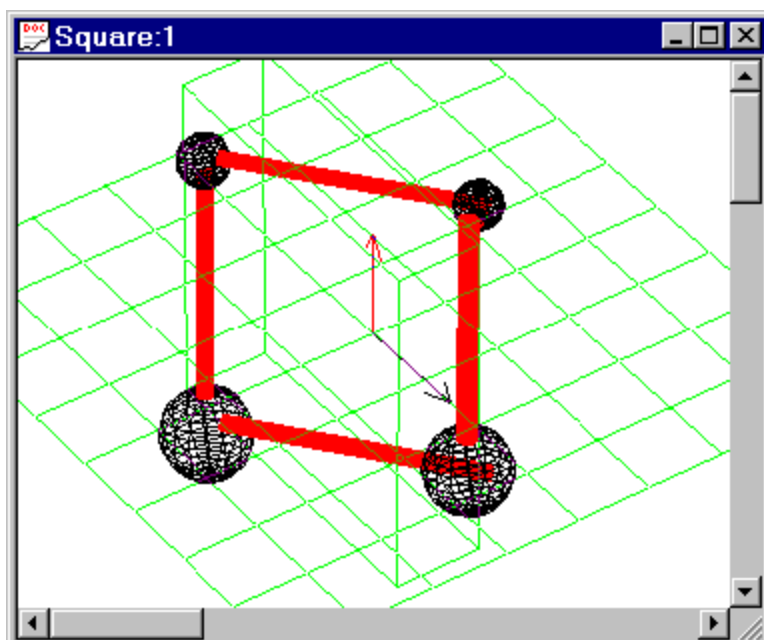

Before

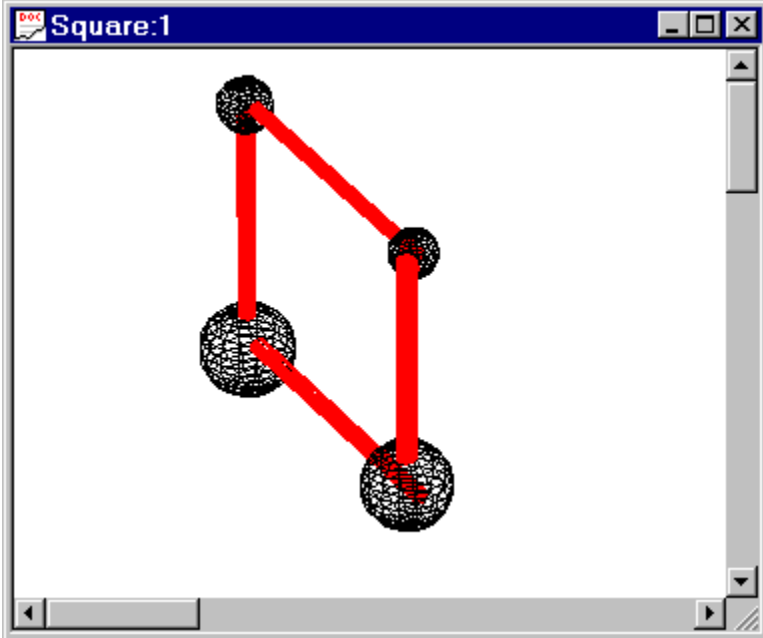

After

Menu: VIEW  
Menu Command: SET WORKING PLANE  
Point 1: Origin of workplane  
Point 2: X axis of workplane  
Point 3: Orientation of workplane  
Point 4: A point defining the front of the plane

The Set Working Plane command can be used to choose a specified plane as a temporary substitute for the XY plane. It adjusts mouse and cursor-key movements accordingly. This feature is very convenient for doing work along oblique faces of complex objects.

### Using the Command

Choose the SET WORKING PLANE command. Set four points for the workplane. Point 1 becomes the new origin. Point 2 determines the X axis of the workplane. Point 3 establishes the orientation of the plane. Point 4 determines the front side of the plane.

### Example: Work on the face of a pyramid.

Select the SET WORKING PLANE command. Set the first point on the lower-left corner of one of the faces. This point sets the origin for the workplane. Set the second point at the lower-right corner of the same face. This sets the X axis for the workplane. Set the third point on the apex of the cone. This sets the orientation, or tilt, of the plane. The last point determines which side of the plane DesignCAD recognizes as the front. When you have done this, the program redraws the cone with the front of the plane facing you.

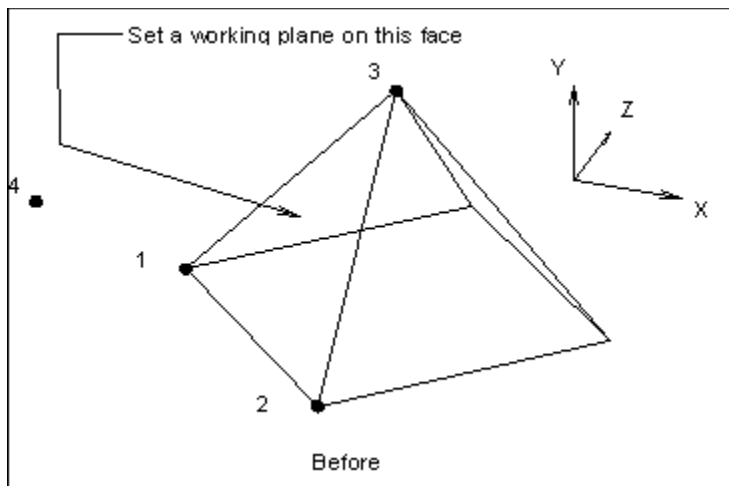

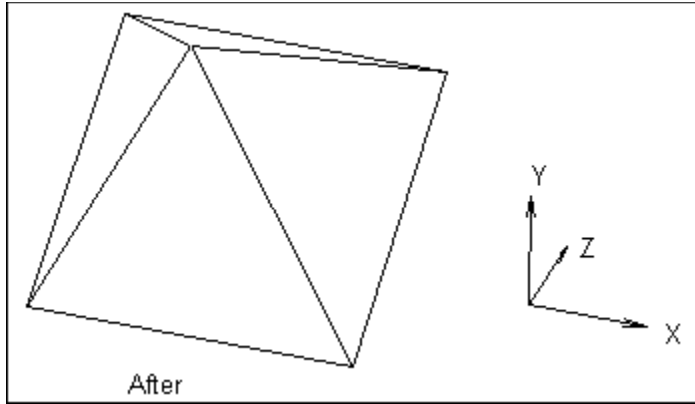

**See Also: *Reset Working Plane Command***



Menu: TOOLS  
Menu Command: SHADING  
Shortcut Key: F8

Toolbox Icon: 

Point 1: First corner of shading region (optional)  
Point 2: Opposite corner of shading region (optional)

The Shading command shades all or part of a drawing. Only solids and planes can be shaded.

### Using the Command

Choose the SHADING command. In the Shading Options box determine the Method and range of shading you want, whether you want to display text, dimensions, lines, or arrows when the drawing is finished shading, and whether you want to use the Anti-Aliasing option.

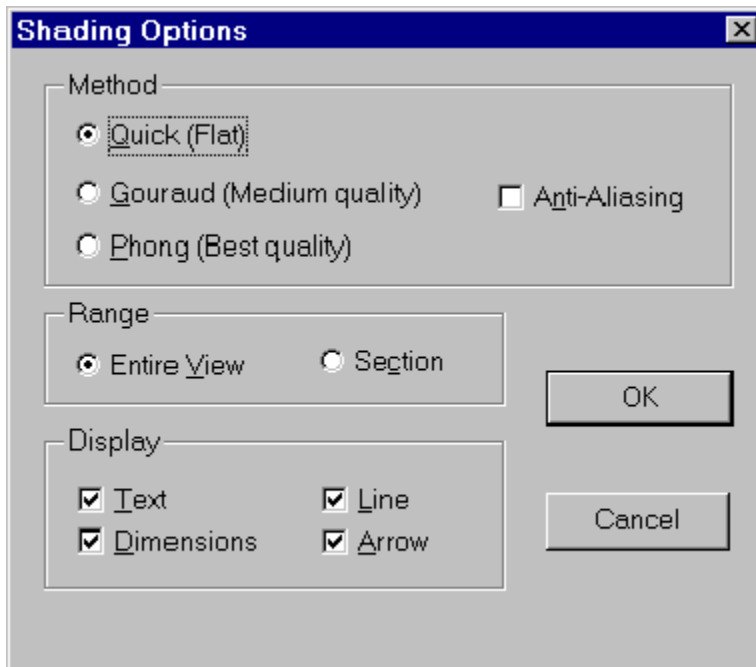

Phong (Best Quality) shading uses a fine shading pattern, and displays the material texture and/or texture mapping.

Gouraud (Medium Quality) shading displays the material texture and or texture mapping, but the resulting shading is not quite as fine as that of Phong shading.

Quick (Flat) shading is quite a bit faster than Phong or Gouraud shading, but the shading is coarser and less realistic. No smoothing takes place, and material textures and texture mapping are not represented.

All three shading methods can be done either for the entire screen or for a rectangular region of the screen. The method you choose becomes the default selection the next time you use the Shading command.

The Anti-Aliasing options tells DesignCAD whether or not to change the color of the object at its edges slightly so that all straight edges will appear smoother. If the Anti-Aliasing option is checked the edges will be smoothed. If the Anti-Aliasing option is not checked some edges will appear slightly jagged.

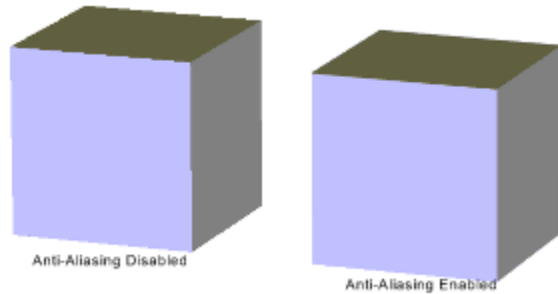

If Windows is configured for only 16 colors, the shaded drawing is not very realistic. If Windows is configured for 32,000 or more colors, however, the shading will be fastest and look very realistic.

You can change the number of colors and the screen resolution used by Windows in the Windows Control Panel, under Display.

Menu: VIEW  
Menu Command: SHOW/HIDE

The Show/Hide command brings up the View Options folder and lets you select the toolboxes and bars you want to display on the screen.

### Using the Command

Choose the SHOW/HIDE command, which brings up the VIEW OPTIONS folder. Click on the check boxes to select the items that you want to be visible on the screen. A marked box indicates an item will be shown on the screen. Click OK.

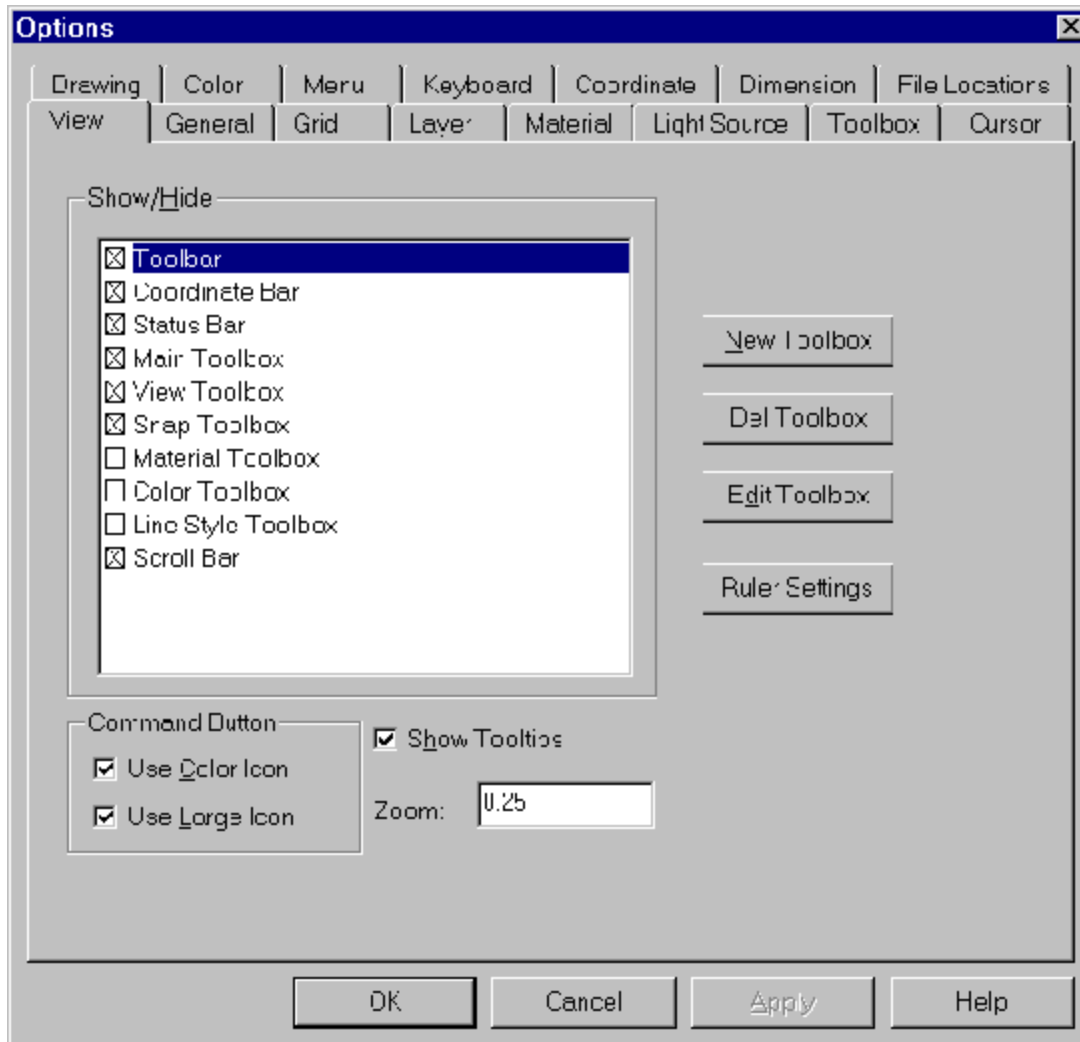

Menu: DRAW  
Submenu: LINES  
Menu Command: SKETCH



Toolbox Icon:

The Sketch command draws freehand by following the cursor's movement.

### Using the Command

Choose the SKETCH command in the Toolbox. Press and hold down the left mouse button. Move the cursor in a curve motion. Release the mouse button. A curve is drawn, following the cursor's movement.

**Note:** The Sketch command only works in 2-D Mode. The default workplane is the XY plane. This plane can be changed in the General Options folder of the Options file box. See the General Options entry in the "Command Reference" section.

---

### Example: Draw freehand curve.

Choose the SKETCH command in the Toolbox. Press and hold down the left mouse button. Draw a curve on the screen. Release the mouse button. The curve will follow the exact path of the cursor.

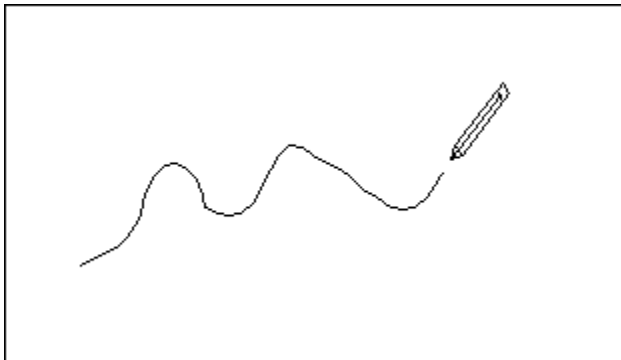

**Note:** The Smooth Line command can be used to "clean up" a line drawn with the Sketch command.

---

**See Also:** *Smooth Line Command*

Menu: EDIT  
Submenu: SELECTION  
Menu Command: SLANT  
Point 1: Reference point  
Point 2: New position for reference point

The Slant command slants one or more selected entities along the X, Y, Z or "free" axis.

### Using the Command

Select the entities to be slanted. Choose the SLANT command from the SELECTION submenu of the EDIT menu. In the Command Line, choose the axis on which the selected objects are to be slanted. Set a reference point in the drawing. Set a second point away from the reference point at the same distance and in the direction that the objects should be slanted. The objects are slanted according to the distance and direction specified.



**Note:** The Primary Selection Handle of the selected object serves as an anchor during the Slant Command. If this handle is located in the center of the object, both sides of the object move from their original positions.

### Example: Slant a box.

Select the box. Set the Primary Selection Handle on the center of the bottom side of the box so it will not be moved. Choose the SLANT command. Select the X axis in the Command Line. Set a reference point at the top-left corner of the box. Set a second point 5 Drawing Units to the left of the reference point. The box is slanted so the top-left corner of the box is 5 Drawing Units to the left of its original position.

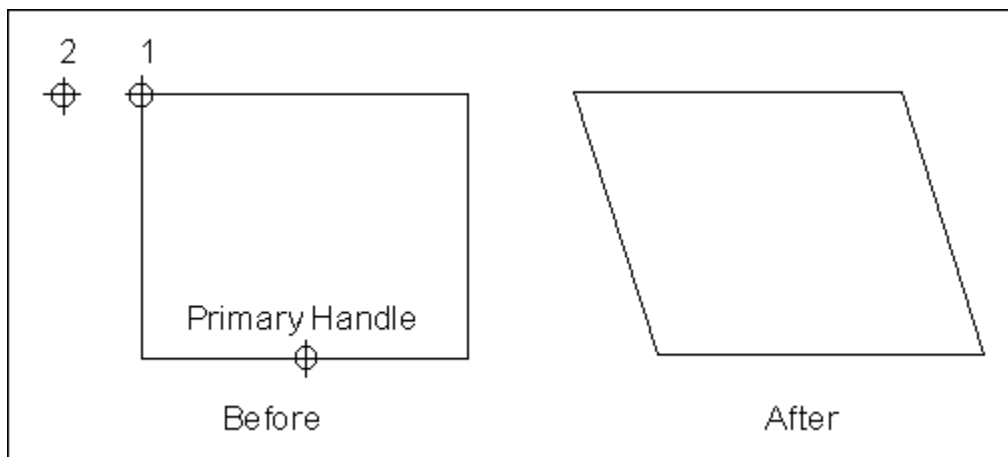

Menu: SOLIDS  
Menu Command: SLICE  
Shortcut Key: **Ctrl+L**  
Points 1-3: Points to define the cutting plane  
Point 4: Region to be removed

The Slice command is used to erase parts of the drawing in front of or behind a plane. The plane can be any plane defined by three points.

### Using the Command

Select the SLICE command and set three points to define the "cutting plane." Then set a point either in front of or behind the cutting plane. All parts of the drawing that lie on that side of the cutting plane will be erased.

All lines and surfaces that cross the plane will be broken at the plane. If the fourth point is not used, then all entities and parts of entities in front of the cutting plane will be erased.

You can choose to run the Slice command on the current selection only by activating that option in the Command Line:



### Example: Cut a selected box along a plane.

Select the SLICE command. Click the SELECTED ITEMS ONLY checkbox. Set the first point on any corner of the box. Set the second point on the corner that is diagonally across the same face of the box. Set a third point on the corner that is diagonally across a face from Point 2. Set the last point on the side of the box that you want removed. The box will be redrawn with the selected portion sliced away.

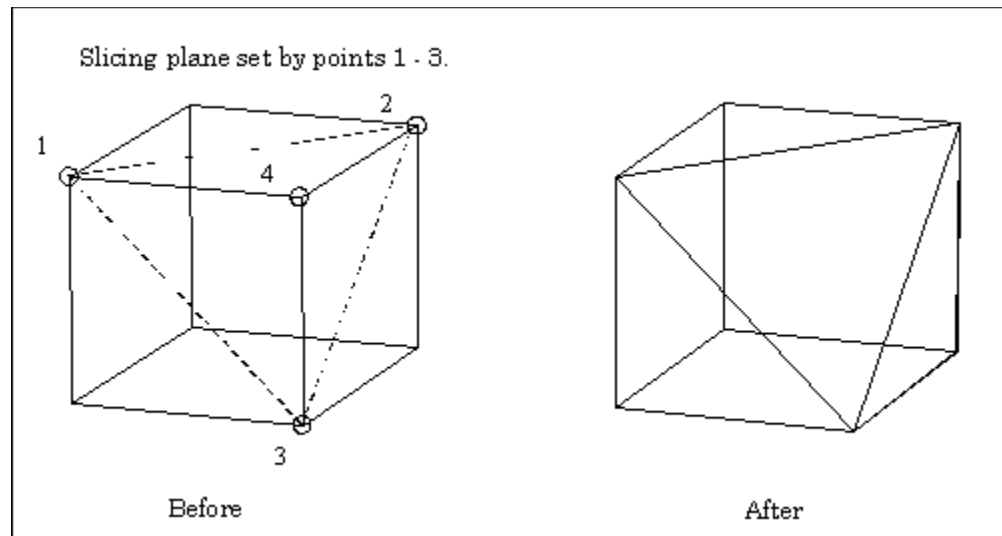

Menu: EDIT  
Submenu: SELECTION  
Menu Command: SMOOTH LINES

The Smooth Lines command smooths complex lines and curves by reducing the number of points in them. Lines will be automatically converted to curves by this command.

### Using the Command

Select the lines and curves to be smoothed. Run the SMOOTH LINES command from the SELECTION submenu of the EDIT menu. The objects are smoothed.

### Example: Smooth a complex line.

Select the line. Choose the SMOOTH LINES command. The line is converted to a smooth curve. The figure below is shown with Point Select Mode turned on to illustrate the reduced number of points in the result.

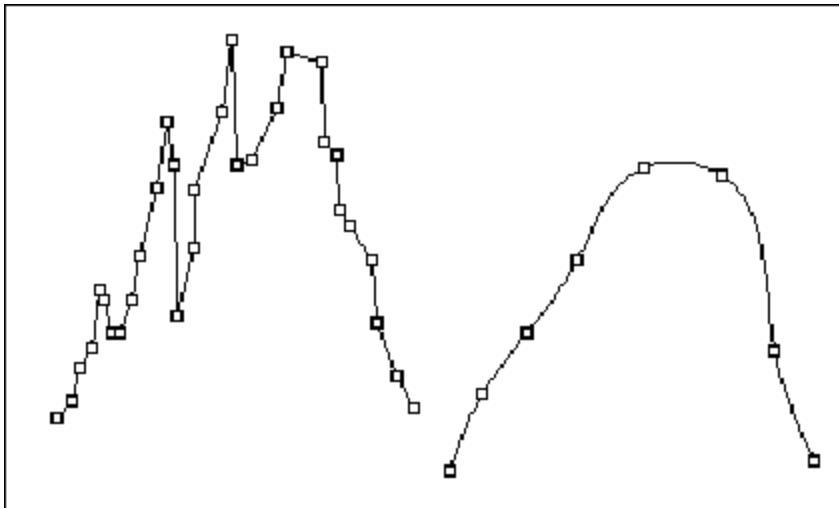

**See Also: *Line to Curve, Curve to Line, Vector Convert***

Menu: OPTIONS  
Menu Command: SNAP GRID  
Shortcut Key: **G**

The Snap Grid command toggles the snap grid off and on. With Snap Grid enabled, any time you set a point with the mouse, the point is set at the nearest location on the grid.

***See Also: Snap Grid Size Command***



Menu: OPTIONS  
Menu Command: SNAP GRID SIZE  
Shortcut Key: **Ctrl+G**

The Snap Grid Size command sets the spacing for the Snap Grid. The Snap Grid size is measured in Drawing Units.

### Using the Command

Choose the SNAP GRID SIZE command to bring up the GRID OPTIONS folder. Set the size in the SNAP GRID SIZE box. Then click the OK button or press **Enter**.

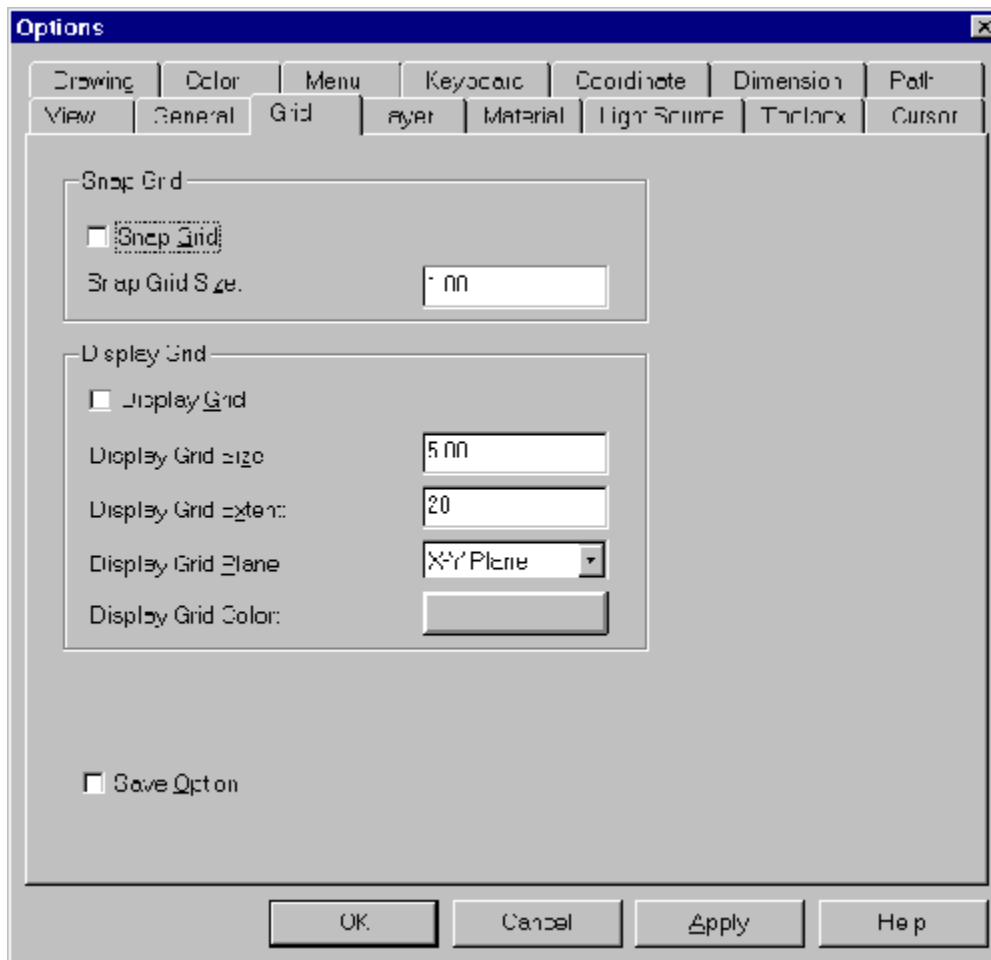

**See Also: Snap Grid Command, Units Command**

Menu: SOLIDS  
Menu Command: SOLID ADD  
Shortcut Key: **Ctrl+J**  
Point 1: First Solid  
Point 2: Solid to be added to first

The Solid Add command is used to "add" one Solid object to another. It makes a single Solid out of two Solids and eliminates the unnecessary surfaces after the addition of the two Solids.

### Using the Command

Choose the Solid Add command. Set a point on each of the Solids to be added. The Solids are then combined into a single Solid, and the surfaces "internal" to the resulting Solid are removed.

**Note:** For best results, the solids should overlap rather than meet exactly at a single face. For example, if you want to stack a cube on top of another, make one cube just a little taller, and place the other cube so that the overall height is correct. When you perform the Solid add, the intervening volume is removed.

---

### Example: Make a single solid from a cylinder passing through a box.

Select the SOLID ADD command and set a point on the box. Set a second point on the cylinder. DesignCAD redraws the two objects as a single Solid, removing the shared volume.

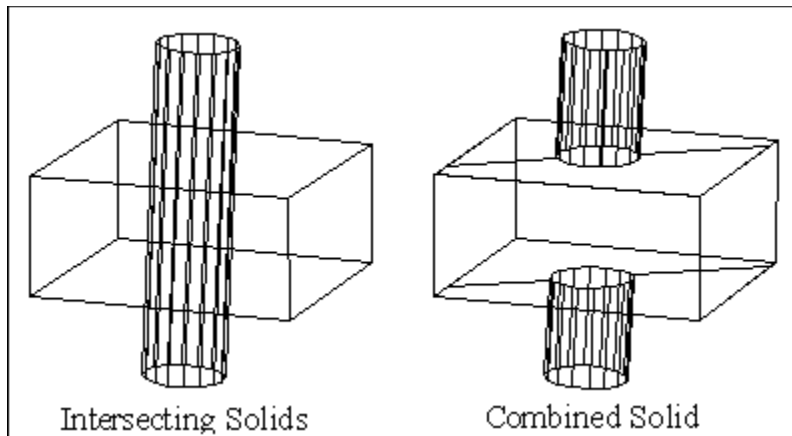

Menu: SOLIDS  
Menu Command: SOLID DEFINE  
Shortcut Key: **Ctrl+D**

The Solid Define command makes DesignCAD recognize all the currently selected entities as a single Solid. This allows you to build Solids from a collection of planes, extrusions, and surfaces.

### **Using the Command**

Select the objects you want to define as one Solid. Choose the SOLID DEFINE command. The Solids are defined as one Solid.

A Solid is a set of planes and surfaces that make up a closed Solid object. A Solid must be defined before performing Solid operations such as Solid Subtract, Solid Add, Solid Intersect, and Interference Checking.

A Solid must be a closed set of planes and surfaces. The Solid Define command does not verify whether the current selection is a legitimate Solid. If you define an invalid Solid, operations such as Solid Subtract may not work correctly.

***See Also: Solid Add Command, Solid Subtract Command, Solid Explode Command***

Menu: SOLIDS  
Menu Command: SOLID EXPLODE

The Solid Explode command can be used to "undefine" a Solid. It reduces a selected Solid into its component parts: planes, surface meshes, and lines. Each component can then be manipulated individually, without affecting the rest of the former Solid.

### **Using the Command**

Select the Solid to be exploded. Choose the Solid Explode command. The Solids now regain their individual properties and can be manipulated as individual Solids.

A Solid is a set of planes and surfaces that make up a closed Solid object. A Solid must be defined before performing Solid operations such as Solid Subtract, Solid Add, and Interference Checking.

Menu: SOLIDS  
Menu Command: SOLID INTERSECT  
Point 1: First Solid  
Point 2: Second Solid

The Solid Intersect command removes all parts of two overlapping Solids except the part that both Solids share. This part forms a new Solid.

### Using the Command

Choose the SOLID INTERSECT command. Set a point on each of the intersection Solids. The overlapping area remains.

### Example: Create a new Solid out of the volume shared by two intersecting Solids.

Select the SOLID INTERSECT command. Set a point on the first Solid, then a point on the second Solid. DesignCAD redraws the new object as a Solid formed by the area previously shared by both objects. The parts of the Solids which did not intersect are removed.

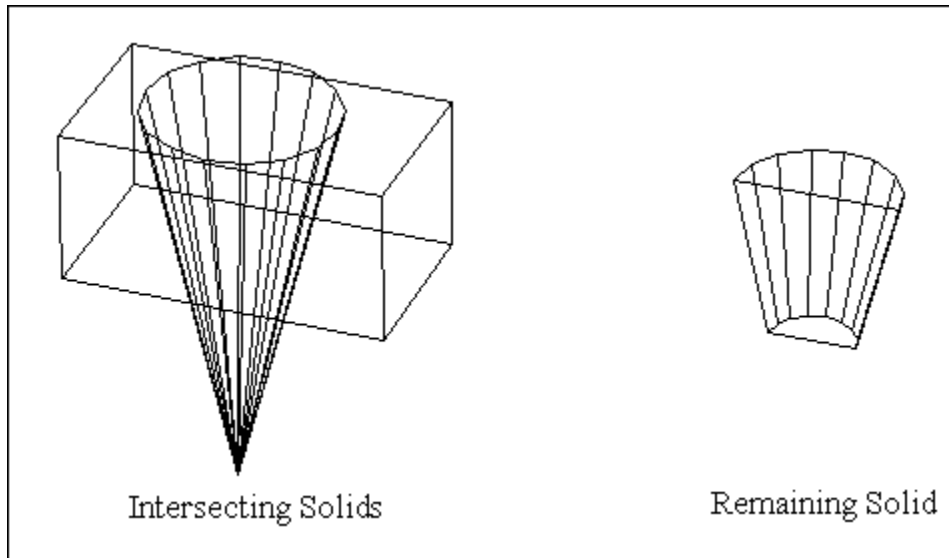

Menu: SOLIDS  
Menu Command: SUBTRACT  
Shortcut Key: **Ctrl+U**  
Point 1: Solid to be removed  
Point 2: Solid to be subtracted from

The Subtract command removes one solid from another solid, a group of solids, a surface, a group of surfaces, or a group of surfaces and solids that it overlaps. For example, to drill a round hole in a Solid object, you can subtract a cylinder from it.

### Using the Command

Choose the SUBTRACT command. Set a point anywhere on the solid to be subtracted (the one that will be used as a template for the hole). Now set a point on the solid, plane, or surface to be drilled (the one that will remain after the solid subtraction). The first solid specified with a point is removed from the second one, leaving all the second solid except the part that coincided with the template (first solid).

### Example: Cut a cylinder out of a box that it intersects.

Select the SUBTRACT command and set a point on the cylinder. Now set a point on the box. The resulting Solid is a box with a hole through it.

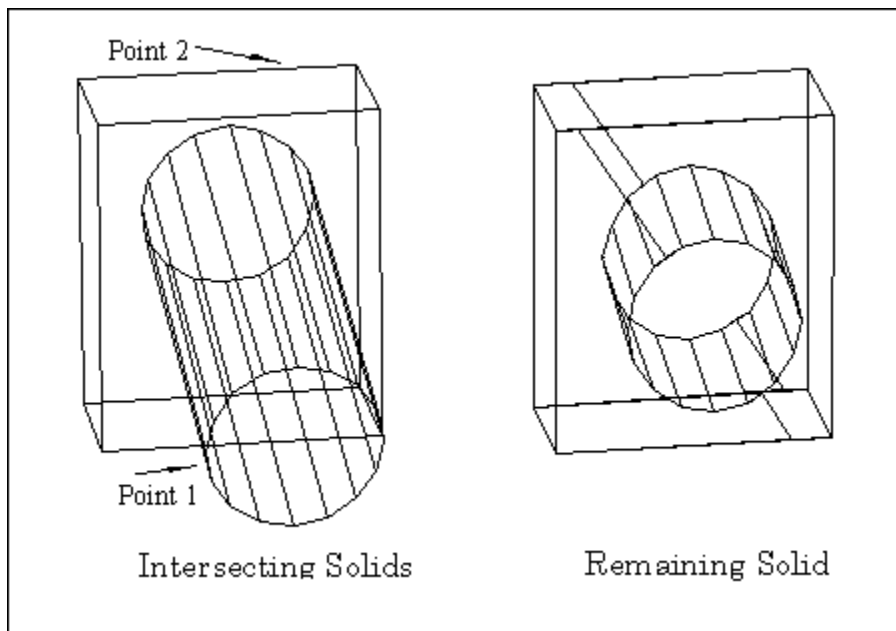

Menu: SOLIDS  
Menu Command: SPHERE



Toolbox Icon:

Point 1: Center of the sphere  
Point 2: Radius of the sphere

The Sphere command draws a solid sphere.

### Using the Command

Choose the SPHERE command. You can specify the number of sides or facets around both the longitude and latitude of the sphere in the FACETS ALONG LONGITUDE AND LATITUDE boxes in the Command Line. The more facets the sphere has, the more spherical it appears.

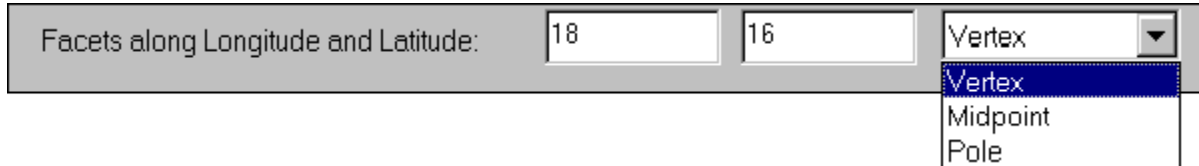

The command requires two points to be set: one for the center of the sphere and one for the radius. You can choose whether the radius of the sphere will be set at a vertex of the equator, a midpoint of the equator, or at one of the sphere's poles. If you choose VERTEX, the equator of the sphere is inscribed by a circle of that radius. If you choose MIDPOINT, the equator of the tube circumscribes a circle of that radius. If you choose POLE, the second point will determine one of the two poles for the sphere. This is normally not significant, but it can be important for some precision drawings.

It may help to think of the sphere as planet Earth. The first point is the center of the Earth. The second point determines the radius of the planet. This point can lie in one of three places: Pole, Vertex, or Midpoint.

If it is the POLE, the sphere is drawn with its axis lying along the line between Points 1 and 2. If you choose VERTEX, the point lies on the equator at one of the longitudinal divisions. If you choose MIDPOINT, the second point will be on the equator midway between two longitudinal lines. If you choose vertex, the second point will be on the equator at the point it intersects on of the longitudinal lines.

The number of faces represents how many longitude sections (divisions along the equator) and the number of latitude sections (divisions from the North pole to the South pole).

### Example: Draw a sphere.

Select the SPHERE command. Set a point for the center. When you move the cursor away from Point 1, a rubber-band sphere appears. It uses the cursor location as Point 2. When the radius of the sphere and the axis of the poles in the X-Y plane are to your liking, set the second point. The sphere is inserted into your drawing.

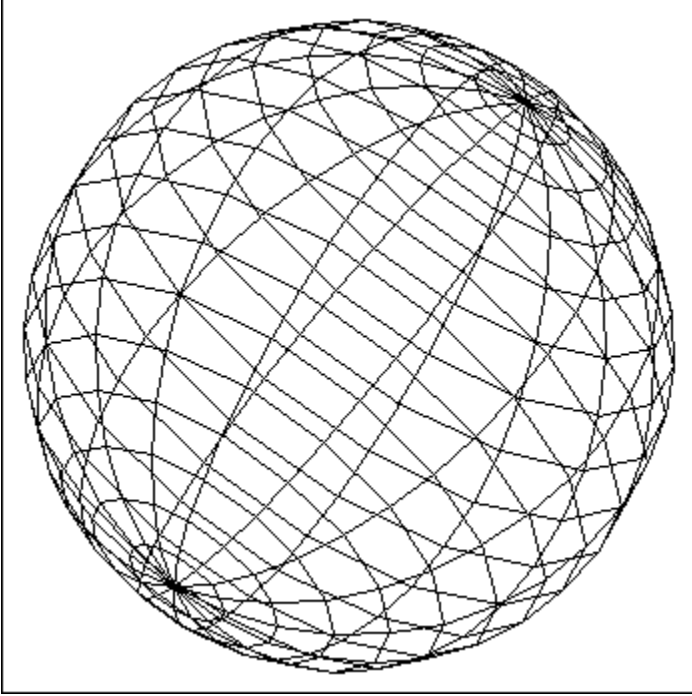



Menu: TOOLS  
Menu Command: STOP MACRO

The Stop Macro command halts the execution of a DesignCAD macro. However, you cannot access the Command Menu to stop the macro if a drawing or shading or similar command is in operation.

Menu: EDIT  
Submenu: SECTION  
Menu Command: STRETCH  
Point 1: 1st corner of area to be stretched  
Point 2: 2nd corner of area to be stretched  
Point 3: Reference point  
Point 4: Stretched position of reference point

The Section Stretch command is used to stretch a section of a drawing from one location to another.

### Using the Command

Choose the STRETCH command. Four points are used with the command. The first two points define a three-dimensional bounding box that contains the part of the drawing to be stretched. The third and fourth points determine the direction and distance that part of the drawing will be stretched.

For instance, if you move the fourth point 10 Drawing Units along the X axis from the third point, then all points in the stretch region will be moved 10 Drawing Units along the X axis.

### Example: Stretch a portion of a plane.

Select the STRETCH command. Set Points 1 and 2 for the bounding box so that a corner of the plane is enclosed. Set Point 3 on the corner point of the plane. Set the final point as the new location for Point 3. The plane is redrawn with the section stretched to the new point.

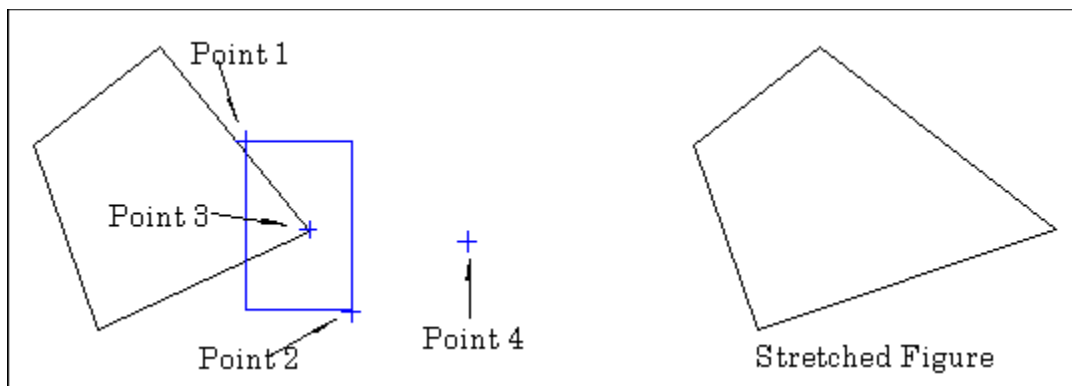

Menu: DIMENSION  
Submenu: INFO  
Menu Command: SURFACE AREA  
Point 1: Object for which surface area is to be calculated

The Surface Area command calculates the surface area of an object.

### Using the Command

Choose the SURFACE AREA command and set a point on the object you want DesignCAD to calculate the surface area for. The calculation is displayed in the following box:

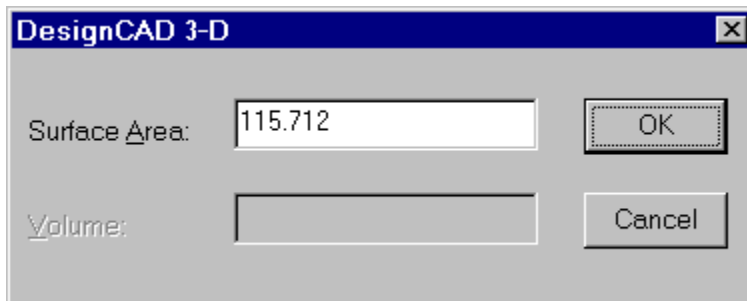

### Example: Calculate the area of a surface in the drawing.

Select the SURFACE AREA command and set a point on the surface. Its surface area is displayed on the screen.

**See Also:** *Volume Command*

Menu: DRAW  
Menu Command: SURFACE CONNECT

Toolbox Icon: 

Point 1: First line to be connected with a surface  
Intermediate Points: Lines or points to define surface path  
Point n: Last line to be connected with a surface

The Surface Connect command is used to stretch a surface between two or more lines. The lines can be planes, lines, curves, arcs, or circles. The original lines to be connected can be any shape and at any orientation in 3-D space.

### Using the Command

Choose the SURFACE CONNECT command. Set a point on each line entity to be connected and changed into a Solid. Press **Enter** to end the command, when you have the necessary points.



### Connecting Surface

There are three options for the connecting surface:

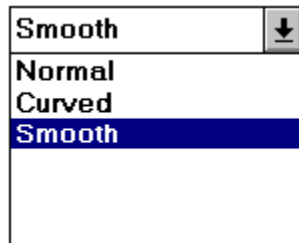

Normal

- Makes a ruled surface between each pair of lines.

Curved

- Forms a ruled surface "bent" to follow the curve defined by the points set between the original lines. It is a straight or linear fit between the original lines.

Smooth

- Forms the smoothest possible surface over the original lines.

### Planes

- This option refers to the number of individual planes to be constructed in the connecting surface *along* the original lines.

### Intermediate Breaks

- This option refers to the number of planes to be constructed in the connecting surface *between* each pair of original lines.

With the Normal and Smooth options, you set a point on each of the original lines to be connected. With the Curved option, you can set additional points in between the original lines to force the surface to curve through those intermediate points.

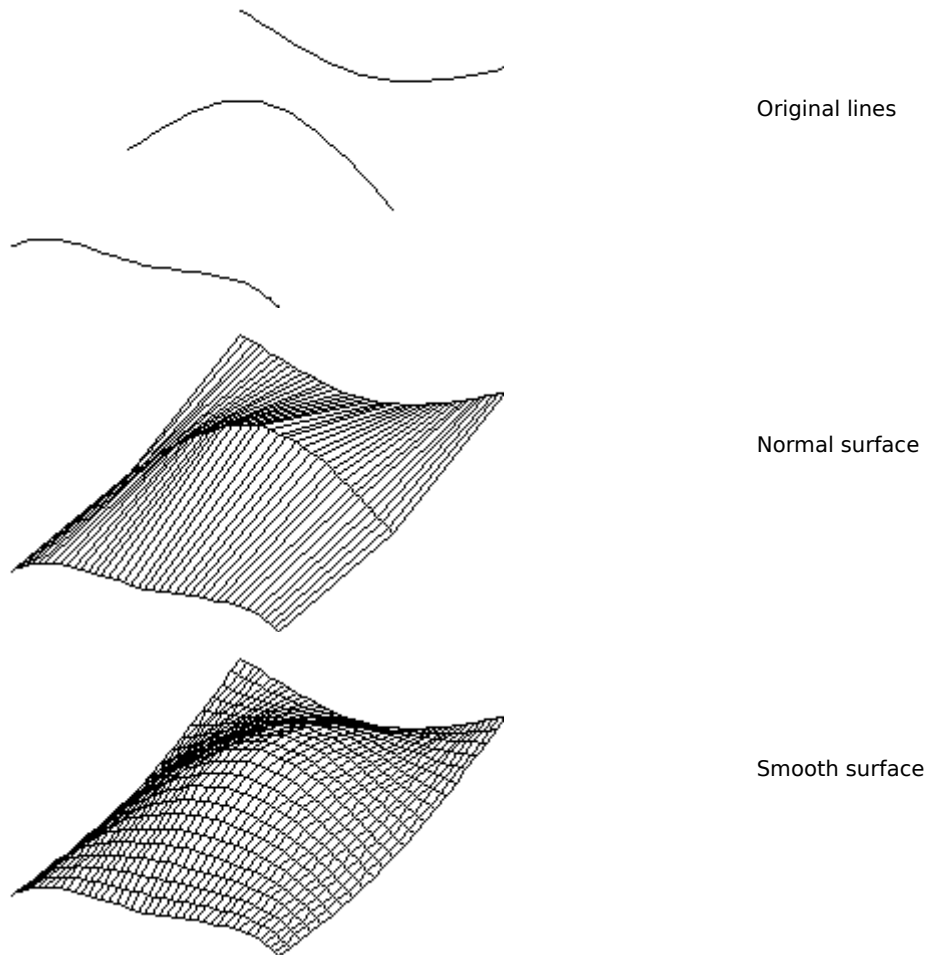

**Example: Connect three lines with a smooth surface.**

Select the SURFACE CONNECT command. Select the SMOOTH option, 40 planes, and 8 INTERMEDIATE BREAKS. Then set a point on each of the three lines and press **Enter**. The lines are connected by a surface.

Menu: DRAW  
Menu Command: SURFACE INTERSECTION



Toolbox Icon:

Point 1: Point on first surface or plane  
Point 2: Point on second surface or plane

The Surface Intersection command draws a line at the intersection of two surfaces. This command can be used on grid surfaces as well as planes.

### Using the Command

Choose the SURFACE INTERSECTION command. Set a point on each of the intersecting surfaces. A line is drawn along the intersection.

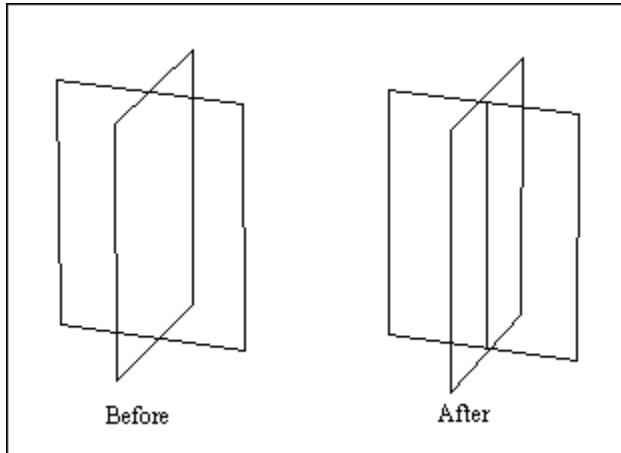

### Example: Draw a line at the intersection of a curved surface and a plane.

Select the SURFACE INTERSECTION command. Set a point on the curved surface and a point on the plane. A line is drawn along the intersection.

Menu: DRAW  
Menu Command: SURFACE PATCH

Toolbox Icon: 

Point 1: First line  
Point 2: Second line  
Point 3: Third line  
Point 4: Fourth line (optional)

The Surface Patch command fits a smooth surface between any three or four lines, curves, or arcs which meet at their endpoints to form a closed area.

### Using the Command

Choose the SURFACE PATCH command. Set a point on each line entity you want to patch. Press Enter when you are finished. The lines are then connected with a grid surface.

You can specify the grid spacing for the surface:

Planes Across:	<input type="text" value="13"/>	Planes Down:	<input type="text" value="13"/>
----------------	---------------------------------	--------------	---------------------------------

**Note:** The line entities must share endpoints and make up a closed area or the Surface Patch command does not work properly.

---

**Example:** Create a grid surface out of four lines or curves that meet at their endpoints to form a closed object.

Select the SURFACE PATCH command. Set a point on each of the four lines. When you are finished, press **Enter**. The lines are connected with a grid surface.

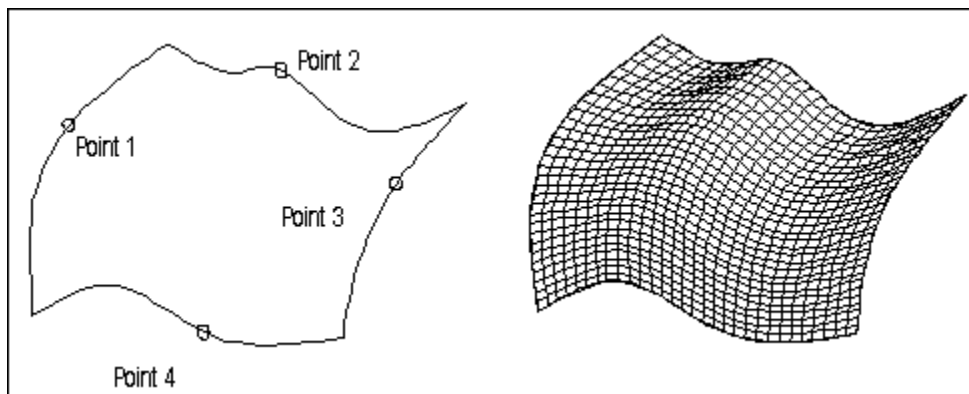

**See Also:** *Surface Connect Command*

Menu: DRAW  
Menu Command: SWEEP  
Shortcut Key: **W**



Toolbox Icon:

Point 1: Center of rotation

Point 2: Second point for axis of rotation (Two Point rotation only)

The Sweep command makes a circular extrusion of selected objects. This command is used to create a circular Solid object from a single line outlining the silhouette of the object. You can also use this command to make a spiral-shaped object such as a spring or a bolt by specifying an offset for the sweep.

### Using the Command

Select the object you want to sweep, and choose the SWEEP command.



#### Copies

- This is the number of times the original shape is replicated. The more copies you make, the smoother the end result appears, but more copies also take longer to shade or edit. For most purposes you will probably want at least 10 copies per revolution (one copy every 36 degrees). The maximum number of copies is 198.

#### Span Angle

- This is the number of degrees the object will sweep about its axis. For a complete, circular extrusion, enter 360°. If you are creating a spiral shape, you can enter more than 360° to achieve more than one revolution. For example, enter 1440 to get four complete revolutions.

#### Offset

- This is the distance along the axis of rotation that the final copy is from the original. For normal, circular sweeps, this should be set to zero. If a value is used here, DesignCAD draws a spiral-shaped object instead of a circular object.

#### Axis

- You can select from five options for the axis of rotation. The object is swept around the first point set, parallel to the axis specified here.

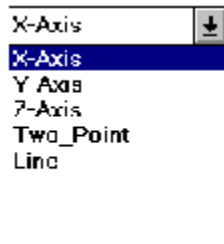

X-, Y-, and Z-Axes



- Each of these options sweep the object around the selected axis centered at the first point.

#### Two Point

- This option can be used to define the axis with two points.

#### Line

- The LINE option can be used to choose an existing line as the axis of rotation.

### **Example: Draw a spool.**

First, draw the outline or shape of the spool (shown below) and select it. Then choose the SWEEP command. Enter **20** in the COPIES box and **360** in the SPAN ANGLE field in the Command Line. Leave the offset as **0**. Choose the Y-AXIS from the AXIS box. Next, set a point to the right of the handle. DesignCAD sweeps the connected lines and forms the spool.

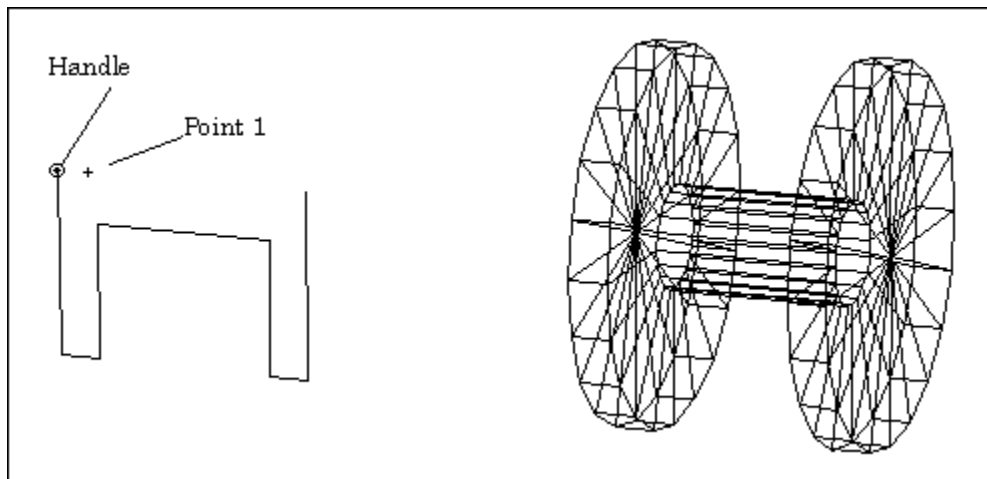

Menu: DRAW  
Submenu: ARC  
Menu Command: TANGENT ARC



Toolbox Icon:  
Point 1: First point of line tangent to arc  
Point 2: Second point of line tangent to arc  
Point 3: Direction in which the arc is to be drawn

The Tangent Arc command lets you draw an arc with a specified radius by defining a line tangent for one end of the arc.

### Using the Command

Select the TANGENT ARC command from the ARC submenu of the DRAW menu. Enter the radius in the RADIUS box in the Command Line. Enter the length for the arc in the LENGTH box.

**Note:** The length of the arc is measured along the arc and is a linear measurement. It is not an angular or chord measurement.

---

Set the first point for the imaginary line to which the arc is to be drawn tangent. Set the second and final point for the line; this point will also serve as the starting point of the arc. (These first two points may be set on the endpoints of an existing line.) After the second point is set, a rubber-band arc is drawn and shows how the arc will be drawn. Move the mouse to determine the orientation of the arc. Set the endpoint for the arc.

### Example: Draw an arc tangent to an existing line.

Select the TANGENT ARC command from the ARC submenu of the DRAW menu. Enter **10** for the radius of the arc in the RADIUS box in the Command Line. Enter **40** for the length of the arc in the LENGTH box. Use the GRAVITY command to set a point on each end of the existing line. A rubber-band arc is drawn to show how the arc would be drawn if the current cursor position were used as the endpoint of the arc. Position the cursor and set a point for the arc's endpoint.

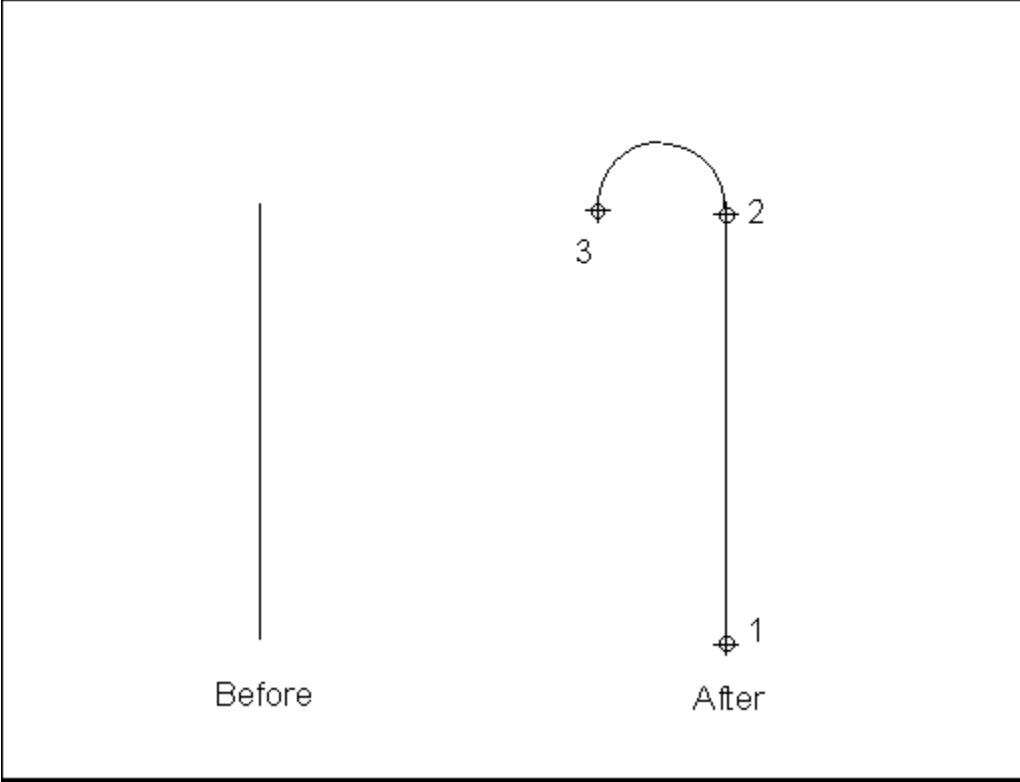

**See Also: Arc Command, Arc (3-Point) Command, Arc (Center, Begin, End) Command, Arc (Endpoints, Center) Command, Arc (Radius, Begin-End) Command**

Menu: DRAW  
Submenu: LINES  
Menu Command: TANGENT BETWEEN CIRCLES



Toolbox Icon:

Point 1: Point near the first circle.  
Point 2: Point near the second circle

The Tangent Between Circles command draws a line tangent to two circles, two arcs, or an arc and a circle. There are four possible lines that can be drawn tangent to any two circles. The command draws a line closest to the two points that you set in the command.

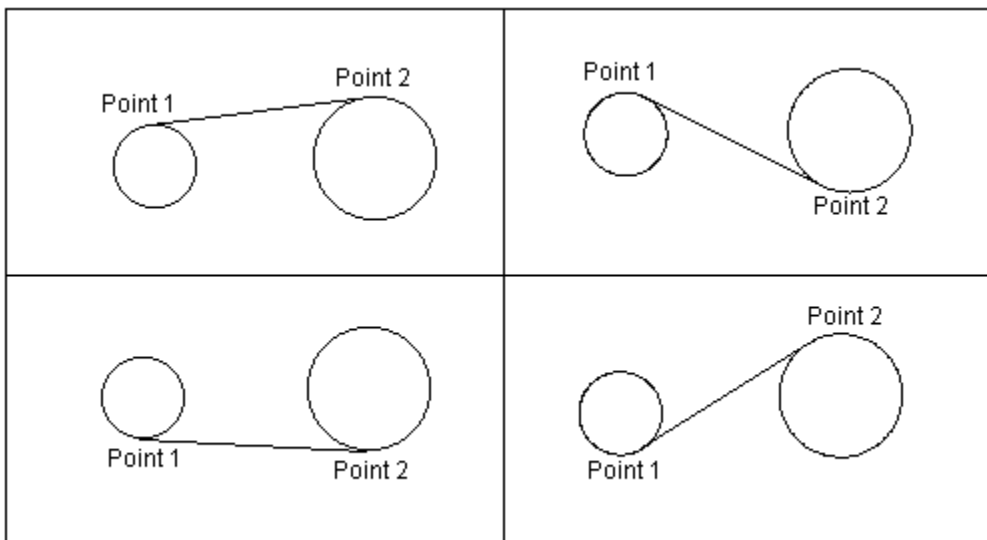

### Using the Command

Choose the TANGENT BETWEEN CIRCLES command in the Toolbox. Set a point on or near the first circle or arc. After the first point is set, a rubber-band line shows how the line will be drawn. Set a point on or near the second circle or arc. A line will be drawn tangent to the two circles or arcs.

**Note:** The Tangent commands do not work on circles that have been saved in vector form. These entities are not true circles. They are line entities approximating a circle. Also, if you are not in 2-D Mode, the two lines must lie in the same plane.

---

### Example: Draw a line tangent to two circles.

Draw two circles. Choose the TANGENT BETWEEN CIRCLES command. Set a point on or near the first circle or arc, close to the point where you want the tangent line to start. Set a second point near the second circle, close to the point where you want the tangent line to end. A line will be drawn tangent to the two circles.

Menu: DRAW  
Submenu: LINES  
Menu Command: TANGENT FROM A CIRCLE

Toolbox Icon: 

Point 1: Point near circle  
Point 2: Endpoint for the tangent line

The Tangent From a Circle command draws a line tangent from a point on a circle, ellipse, arc, or elliptical arc to another point..

### Using the Command

Choose the TANGENT FROM A CIRCLE command in the Toolbox. Set a point on or near the circle or arc. After the first point is set, a rubber-band line shows how the tangent will be drawn. Set a point for the end of the line on or near the line tangent to the circle or arc. The endpoint of the line will be even with the second point. A line will be drawn from the first point to the second point, tangent to the circle or arc.

### Example: Draw a line tangent from a circle.

Choose the TANGENT FROM A CIRCLE command in the Toolbox. Set a point on or near the circle or arc. Notice as you move the cursor around the screen that a rubber-band line extends from the cursor to a point tangent to the circle. Set a point for the endpoint of the tangent line.

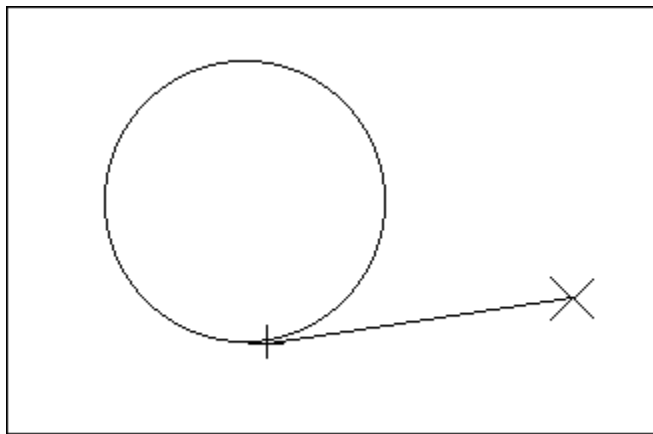

Menu: DRAW  
Submenu: LINES  
Menu Command: TANGENT TO A CIRCLE

Toolbox Icon: 

Point 1: Endpoint for the tangent line  
Point 2: Point near the circle

The Tangent to a Circle command draws a line tangent from a point to a circle, ellipse, arc, or elliptical arc. There are two possible lines that can be drawn tangent to a circle from a single point. The line drawn is the one closest to the second point.

### Using the Command

Choose the TANGENT TO A CIRCLE command in the Toolbox. Set a point for the beginning of the line. After the first point is set, a rubber-band line shows how the line will be drawn. Set a point on or near the circle or arc. A line will be drawn from the first point tangent to the circle or arc.

**Note:** If you are not in 2-D Mode, the line and circle must lie in the same plane.

---

### Example: Draw a line tangent to a circle.

Choose the TANGENT TO A CIRCLE command in the Toolbox. Set a point for the beginning of the line. Move the cursor near the circle. A rubber-band line shows how the line will be drawn. Set the second point to draw the line.

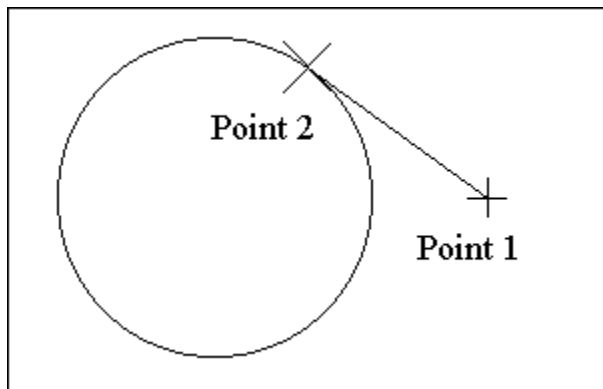

Menu: DRAW  
Menu Command: TEXT 2-D  
Shortcut Key: **Ctrl+T**

Toolbox Icon: 

Point 1: Lower-left corner  
Point 2: Lower-right corner (optional)

The Text 2-D command inserts a string of 2-D text into the drawing. This text appears flat regardless of the viewing angle you are using.

### Using the Command

Choose the TEXT 2D command in the Toolbox. Click the TEXT box in the Command Line and enter the text. The Text box keeps a history of the last 20 entries. To use this feature, click the down arrow on the right end of the box and highlight the entry to be used again.



Click the  button to see the TEXT OPTION box.

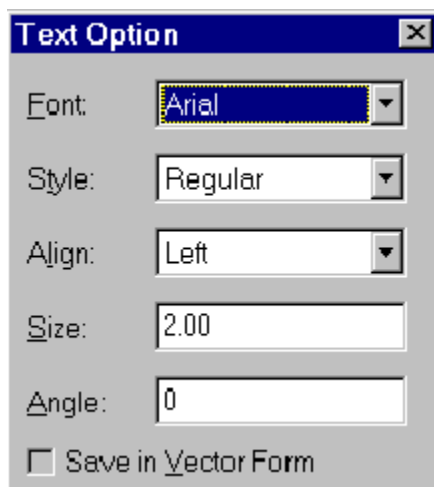

Click the SAME AS button  and then click on a line of text in the drawing to apply the same options to the new text.

Click the TEXT INSERT button  to display the Text Insert box.

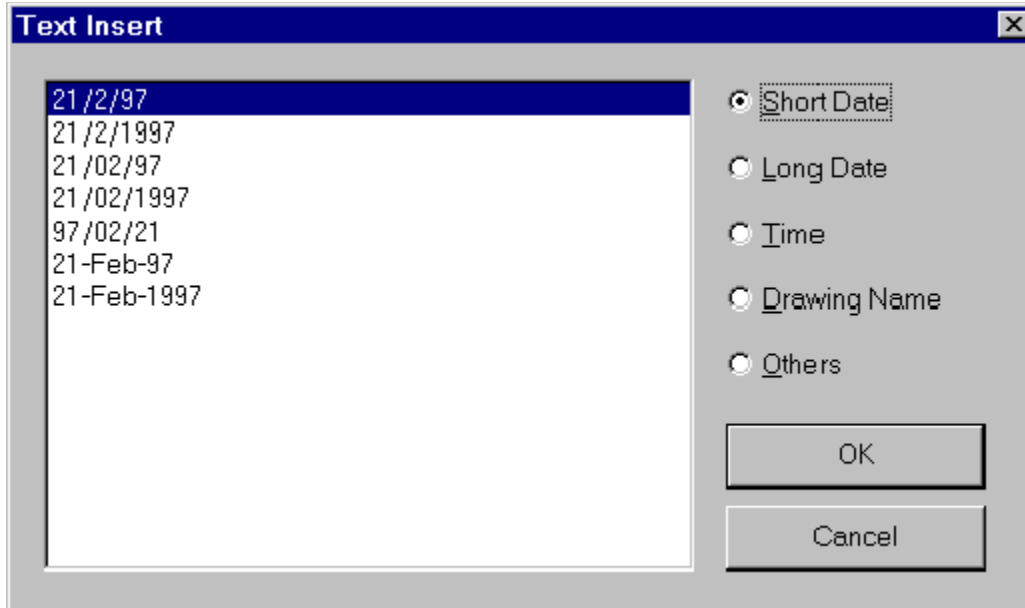

Choose the kind of text you would like to have automatically inserted from the list of items to the right of the Text Insert dialog main window: Short Date for example. Using the mouse, click the format for the item from those displayed in the main window of the Text Insert dialog and then click the OK button.

Set a point for the bottom of the text. Next, Set a point to determine the angle of the text, or click the middle mouse button or press **Enter** to have the text drawn using the angle set in the Text Option box. The text will be drawn according to the points and the options selected.

**Example: Insert text into your drawing that will be visible in every view.**

Select the TEXT 2-D command. Enter the desired text in the TEXT box in the Command Line. A rubber-band text box follows the cursor on the drawing screen. Move the cursor to the place where you want the text inserted and set a point for the lower-left corner. The location of the second point determines the orientation of the text. Set these points where you like. Look at the drawing in different views. Notice that while the text position may change, its orientation (facing you) never changes.

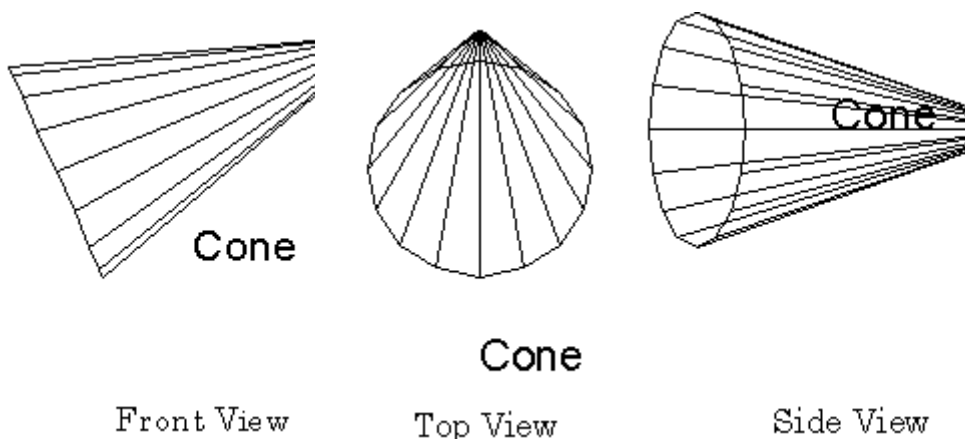



Menu: DRAW  
Menu Command: TEXT 3-D  
Shortcut Key: T

Toolbox Icon: 

Point 1: Lower-left corner of text  
Point 2: Lower-right corner of text (optional)  
Point 3: Plane on which the text lies (optional)

The Text 3-D command inserts 3-D text into the drawing. This text can be placed at any 3-D orientation. Its appearance varies depending on the current viewing parameters.

### Using the Command

Choose the TEXT 3-D command. Set the options you want and return to the drawing screen. A rubber-band box shows how the text will be drawn.

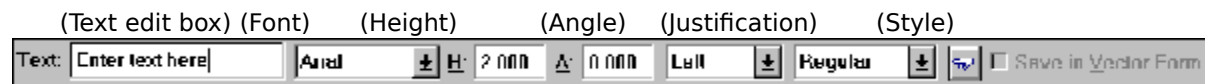

With the Text 3D command, you can set one to three points. If only one point is used, the size and angle of the text is determined by the text size angle in the Command Line.

The second point is used to specify the length and angle of the text. The lower-right corner of the text will be positioned at the second point.

The third point, if used, defines the plane on which the text is to be drawn. For example, if the third point is above the first, the text will be upright. If the third point is "behind" the first, then the text will be positioned to be read from above. It will be "flat" on the X-Z plane.

### Example: Insert text into your drawing that will keep its orientation to other objects in the drawing.

Select the TEXT 3-D command. Enter the desired text in the TEXT box in the Command Line. A rubber-band text box follows the cursor on the drawing screen. Move the cursor to where you want the text inserted and set a point for the lower-left corner. Also set points for the lower-right and upper-left corners of the 3-D text box. Look at the drawing in different views. Notice that the text position and orientation change in each view.

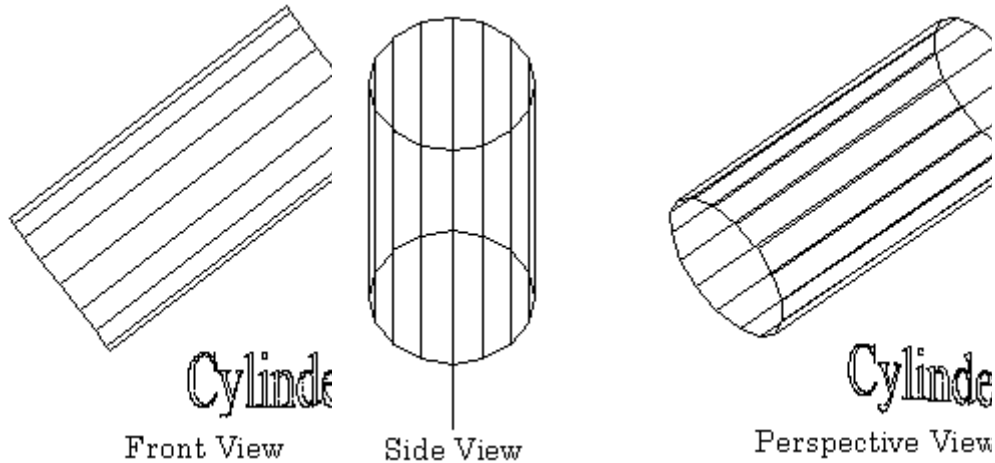

Menu: DRAW  
 Menu Command: TEXT ARC



- Point 1: Start of the text arc
- Point 2: Center of the text arc
- Point 3: End of the text arc

The Text Arc command draws text along an arc. The arc is defined by a beginning point, a center point, and an end point.

### Using the Command

Choose the TEXT ARC command in the Toolbox. Enter the in the TEXT box in the Command Line. Set the font and style options in the Command Line.



Set a point for the beginning of the text arc. Set a point for the center of the text arc. Set a point for the end of the text arc. The text will be drawn in an arc, beginning with the first point and ending with the last point.

Choose SAVE IN VECTOR FORM to use line entities to outline the text, instead of putting in actual text. These outlines can be swept or extruded, whereas text cannot.

**Note:** The Vscale setting determines the *relative* height of the text compared to normal text. The default is 1.0, which scales text normally according to the length of the arc. Setting this to 2.0 would create taller letters of the regular width, while setting it to 0.5 would create really short letters.

### Example: Draw a text arc.

Choose the TEXT ARC command in the Toolbox. Enter the text in the TEXT box in the Command Line. Set points for the beginning, center, and end of the arc. The text will be inserted along the

arc.

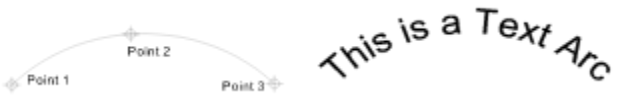

Menu: DRAW  
Menu Command: TEXT BLOCK  
Point 1: Top of the Text Block  
Point 2: Point determining angle of the Text Block (optional)

The Text Block command allows drawing text to occupy multiple lines and sets the size, angle, and orientation of the text. Points determine the position and angle of the text in the drawing.

### Using the Command

Choose the TEXT BLOCK command from the DRAW menu. Enter the desired spacing between lines in the LINE SPACING box. Click the TEXT box in the TEXT BLOCK box and enter the text. When typing in the TEXT box press **Ctrl+Enter** to drop to the next line.

Click the T button to see the TEXT OPTION box.

Click the SAME AS button and then click on a Text Block in the drawing to apply the same options to the new text.

Set a point for the top of the text. Set a point to determine the angle of the text, or click the middle mouse button or press **Enter** to have the text drawn using the angle set in the Text Option box. The text will be drawn according to the points and the options selected.

### Example: Insert a Text Block into a drawing.

Choose the TEXT BLOCK command. Click the TEXT box in the TEXT BLOCK box and enter the text you want to appear in your drawing. Press **Ctrl+Enter** to drop down a line. When you have finished the entry, set a point for the bottom of the text. Press ENTER to insert the text.

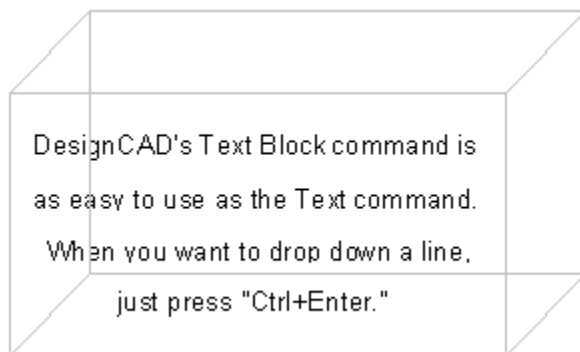

Menu: DRAW  
Menu Command: TICKMARK



Toolbox Icon:  
Point 1: Point on line, curve, or arc  
Point 2: Point indicating on which side of line, curve, or arc tick marks are to be drawn

The Tickmark command draws short lines, or tick marks, along a line, curve, ellipse, or circle entity. These tick marks are spaced at specified intervals along the entity.

### Using the Command

Choose the TICKMARK command in the Toolbox. Enter the number of sections of large tick marks in the SECTIONS box in the Command Line. This determines the number of large tick marks to be evenly measured out along the length of the item being marked.

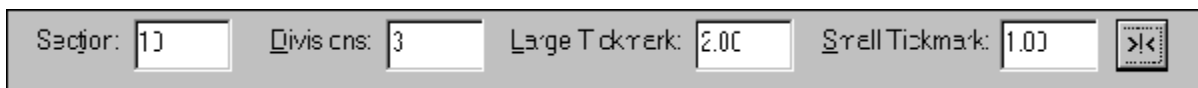

>|< If you would rather determine the exact distance between large tickmarks click the Even/Exact Switch button in the Command Line. The Sections box will be replaced with the Mark Distance box. This box lets you specify the exact distance between the large tick marks. To switch back to the Sections box, click the button again.

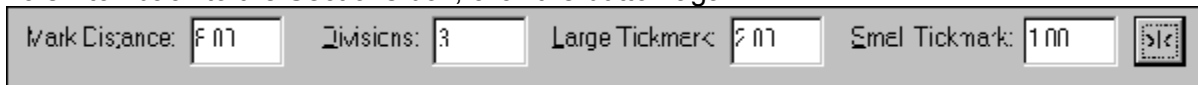

Enter the number of divisions of tick marks in the DIVISIONS box. This divides each section up with small tick marks. Enter the large tick mark size in the LARGE TICKMARK box. Enter the small tick mark size in the SMALL TICKMARK box. Set a point on the existing line. Set a point to indicate on which side of the line the tick marks will be drawn. If both points are set in the same location, the tick marks will be centered on the line. Tick marks will be drawn at even intervals along the line, on the side of the second point.

### Example: Draw tick marks along a 10 unit line.

Draw a 10-unit-long line using the Line command. Choose the TICKMARK command in the Toolbox. Enter **10** in the SECTIONS box in the Command Line. Enter **4** in the DIVISIONS box. Set a point on the line. Decide on which side of the line the tick marks should be placed. Set another point to that side of the line. The tick marks will be drawn as follows: 10 one-unit sections, 4 divisions to each section.

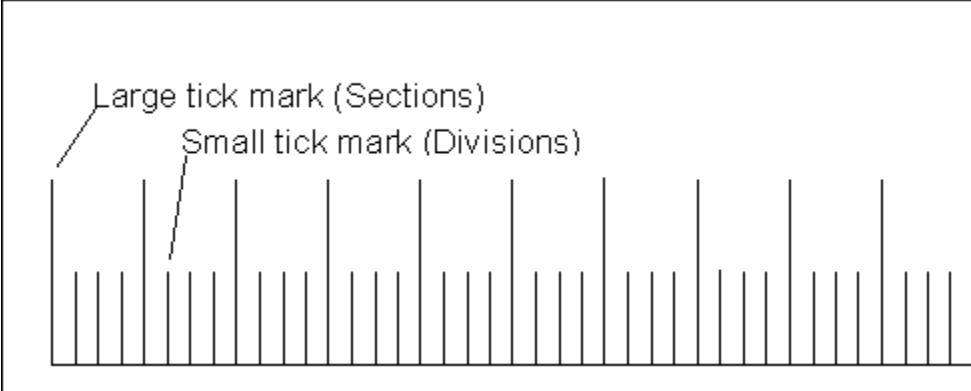

Menu: WINDOW  
Menu Command: TILE HORIZONTAL

The Tile Horizontal command organizes your open windows by arranging them horizontally across the screen. Each window takes up the same amount of space on the screen.

### Using the Command

Select the TILE HORIZONTAL command from the WINDOW menu. The open drawing windows are stacked on top of each other.

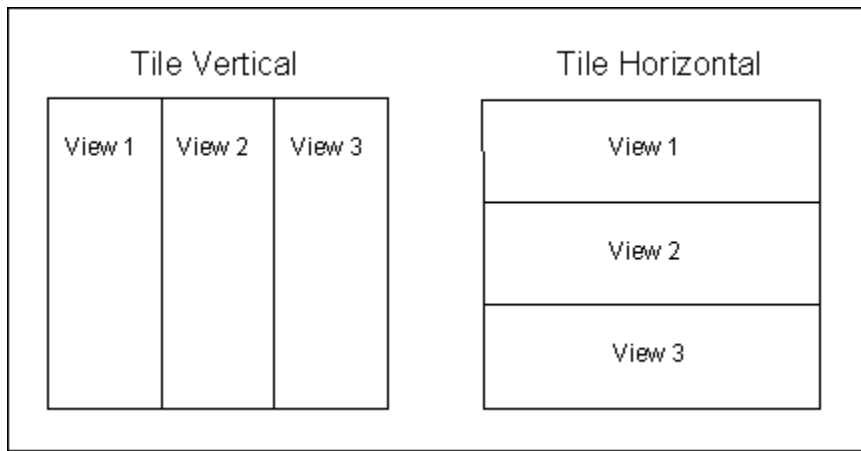

Menu: WINDOW  
Menu Command: TILE VERTICAL

The Tile Vertical command organizes your open windows by arranging them vertically across the screen. Each window takes up the same amount of space on the screen.

### Using the Command

Select the command from the WINDOW menu. The open drawing windows will be placed side-by-side.

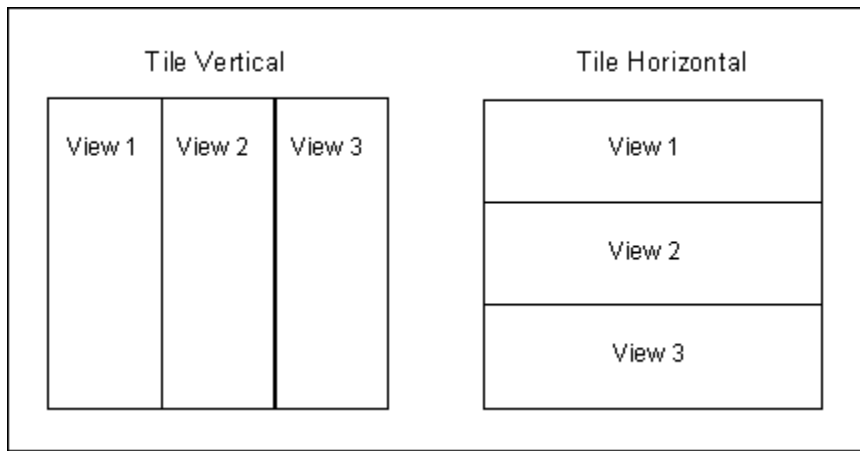



Menu: TOOLS  
Submenu: CUSTOMIZE  
Menu Command: TOOLBAR

The Toolbar command is a shortcut method of bringing up the Toolbox folder of the Options file box.

### **Using the Command**

Choose the TOOLBAR command from the CUSTOMIZE submenu of the TOOLS menu. The Options file box is displayed with the Toolbox folder showing. For a complete listing of the options available in this folder, see Toolbox Options.

***See Also: Toolbox Options***

Menu: OPTIONS  
Menu Command: OPTIONS

The Toolbox Options folder can be used to configure toolbox settings.

### Using the Command

Choose the OPTIONS command. Then click on the Toolbox tab to bring up the TOOLBOX OPTIONS folder.

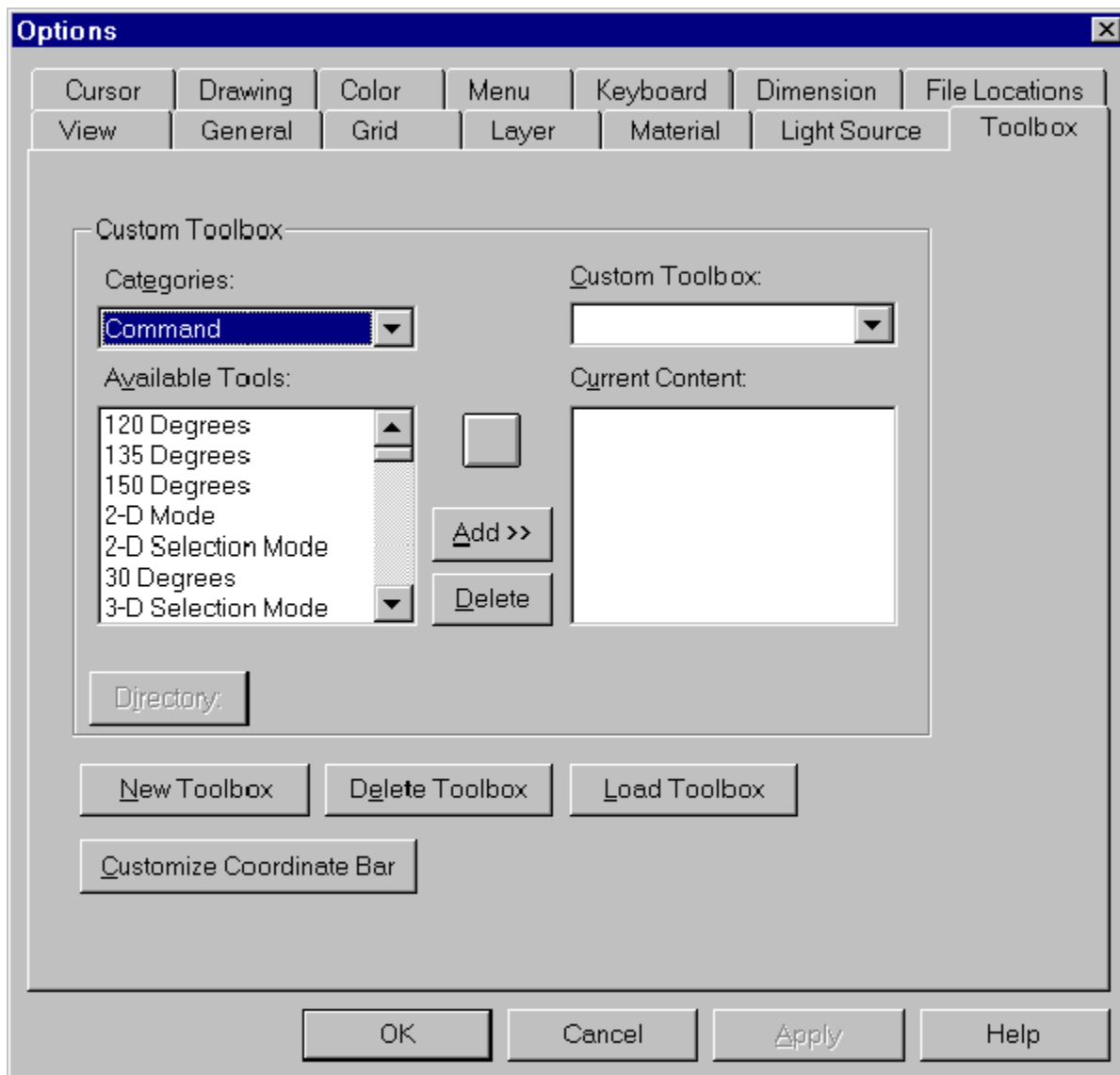

### Custom Toolbox

#### Categories

- You can choose to insert commands, macros, or BasicCAD programs into the Custom Toolbox. Each toolbox can hold as many as 48 items.

#### Available Tools

- Choose which tools you want to add to the Custom Toolbox from the list.

#### Current Content

- This is a list of tools which are currently in the Custom Toolbox.

#### Icon

- This button displays the icon for the highlighted tool.

#### Add

- This button inserts a selected tool into the Custom Toolbox.

**Note:** You can also insert a command icon into a Custom Toolbox by holding down **Ctrl** while clicking and dragging the icon from another tool box into the Custom Toolbox.

---

#### Delete

- This button removes a selected tool from the Custom Toolbox.

#### **Directory**

This button allows you to choose the directory for macros and BasicCAD files.

#### **New Toolbox**

This button prompts you for a Custom Toolbox name and creates a new toolbox to which you may add commands.

#### **Delete Toolbox**

This button deletes the currently selected Custom Toolbox.

#### **Load Toolbox**

This button loads the .dct file for a Custom Toolbox.

#### **Customize Coordinate Bar**

This button opens the Coordinate dialog box.



**Note:** The Angle field is only available for 2-D Mode.

This box is used to determine what values are displayed in the Coordinate bar. Click on the box to the left of the item you want to display. A check mark will be placed in the box to indicate that it is visible. Click again to deselect and turn off the item. The check mark is removed to indicate that the item is hidden. Click SAVE AS DEFAULT to save the changes to the next drawing session. Click the OK button to accept the changes and return to the Toolbox Options folder. Click the CANCEL button to return to the Toolbox Options folder without changing anything.

Menu: SOLIDS

Menu Command: TORUS



Toolbox Icon:

Point 1: Center of the torus

Point 2: Center of the cross-section

Point 3: Radius of the cross-section

The Torus command draws a solid torus.

### Using the Command

Choose the TORUS command. You can specify the number of sides or facets around both the longitude and latitude of the torus in the FACETS ALONG LONGITUDE AND LATITUDE boxes in the Command Line. The more facets the torus has, the smoother it appears.

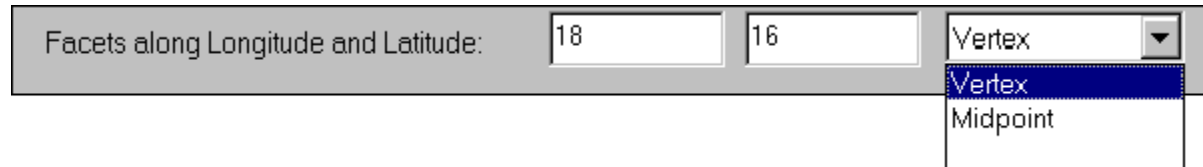

The command requires three points to be set: one for the center of the torus; a second for the center of the cross-section; and a third for the radius of the cross-section. You can choose whether the second and third points will be set at a vertex of the torus' perimeter and cross-section or a midpoint of its perimeter and cross-section.

If you choose VERTEX, the center for the cross-section of the torus is inscribed by a circle of the radius defined by the distance from Point 2 to Point 1. If you choose MIDPOINT, the center for the cross-section circumscribes a circle of that radius. Also, if you choose VERTEX, the cross-section of the torus is inscribed by a circle of the radius defined by the distance from Point 3 to Point 2. If you choose MIDPOINT, the cross-section of the torus circumscribes a circle of that radius. This is normally not significant, but it can be important for some precision drawings.

### Example: Draw a torus in your drawing.

Select the TORUS command. Enter **5** in the LONGITUDE box (left) in the Command Line. Enter **10** in the LATITUDE box (right). Choose VERTEX or MIDPOINT. Set a point for the center of the torus. Move the cursor out along the Y axis and set the second point for the center of the cross-section. Next, set a third point for the radius of the cross-section.

**Hint:** Points 1, 2 and 3 should not lie on a straight line.

---

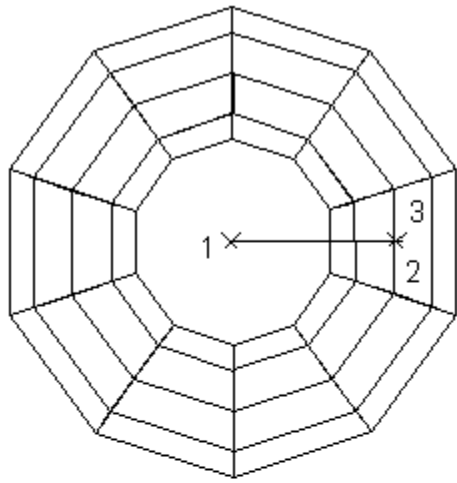

Midpoint

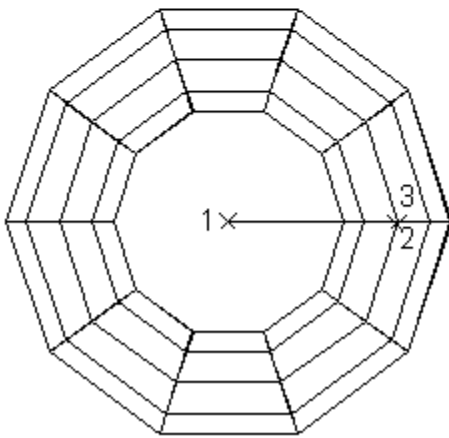
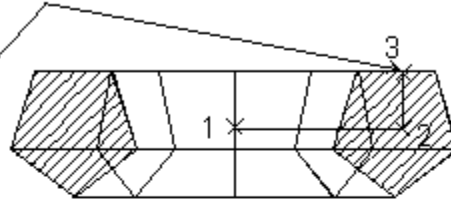

Vertex

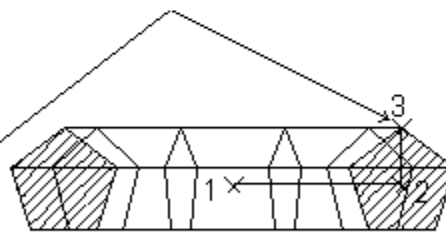

Menu: EDIT  
Submenu: TRIM/EXTEND  
Menu Command: TRIM BETWEEN TWO LINES  
Point 1: Line to be trimmed  
Point 2: First intersecting line  
Point 3: Second intersecting line

The Trim Between Two Lines command erases a segment of a line between its intersection with two other lines.

### Using the Command

Choose the TRIM BETWEEN TWO LINES command from the Toolbox. Set a point on the line to be trimmed. Set a point on the first intersecting line. Set a point on the second intersecting line. The line is trimmed between the other two lines.

**Note:** In 3D mode, all the lines must lie in the same plane for this command to trim them. In 2-D Mode, the command will trim the lines along their XY projections.

---

### Example: Trim a line between two other lines.

Draw three lines in the shape of a letter "H," with the horizontal line passing through both vertical lines. Select the TRIM BETWEEN TWO LINES command from the Toolbox. Set a point on the horizontal section. Then set points on the vertical lines. The part of the horizontal line between the vertical lines is removed.

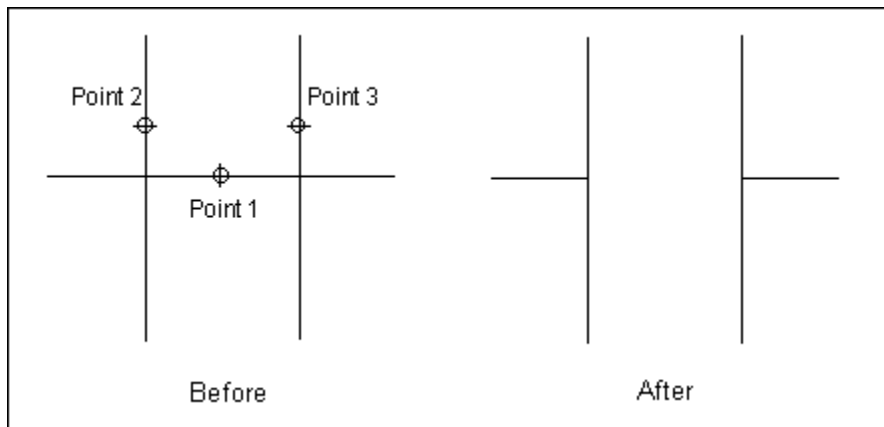

Menu: EDIT  
Submenu: TRIM/EXTEND  
Menu Command: TRIM DOUBLE LINES  
Shortcut Key: **Ctrl+B**

Toolbox Icon: 

Point 1: Corner of area containing lines to be trimmed  
Point 2: Opposite corner of area containing lines to be trimmed

The Trim Double Lines command "trims" two sets of parallel lines at their intersection.

### Using the Command

Choose the TRIM DOUBLE LINES command from the Toolbox. To trim the lines within a specified area, click the SELECT TRIM AREA button in the Command Line. Next, set a point in the corner of the area containing the lines to be trimmed. Set a point in the opposite corner of the area containing the lines to be trimmed. The two sets of lines will be trimmed to their intersection. Depending on the configuration of the lines, they will be trimmed to a "+," a "T," or an "L" shape.

**-or-**

To trim certain lines within an area, click the SELECT TRIM LINES AND AREA button in the Command Line. Then select each of the four lines to be trimmed. The two sets of lines will be trimmed to their intersection. Depending on the configuration of the lines, they will be trimmed to a "+," a "T," or an "L" shape.

**Note:** In 3-D mode, all the lines must lie in the same plane for this command to trim them. In 2-D Mode, the command will trim the lines along their XY projections.

---

### Example: Trim double lines in your drawing.

Draw four lines (two vertical, two horizontal) so that they look like a number symbol (#). Click the SELECT TRIM AREA button in the Command Line. Set a point for a corner of the area to be trimmed. Set another point for the opposite corner of the area to be trimmed. The two sets of lines will be trimmed at their intersection.



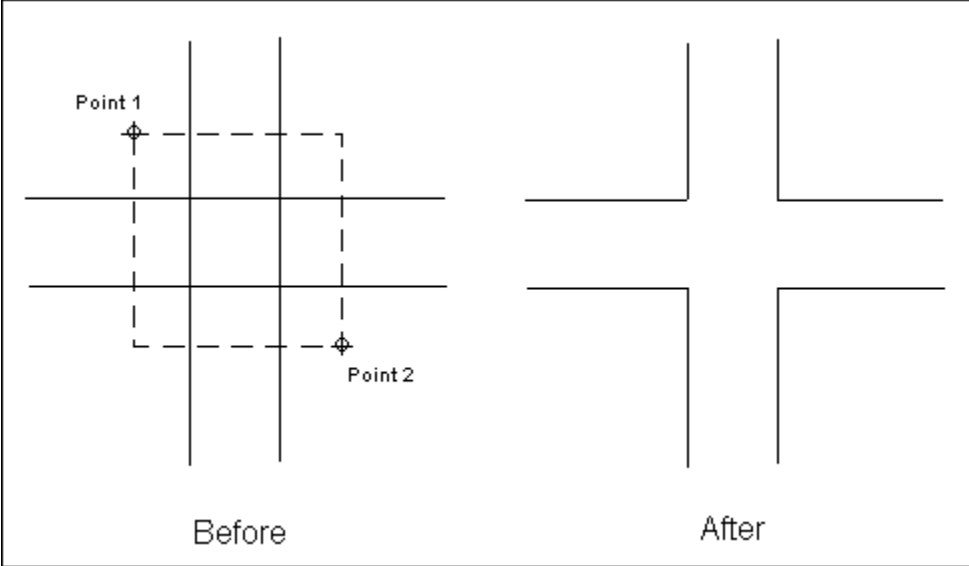

Menu: EDIT  
Submenu: TRIM/EXTEND  
Menu Command: TRIM ONE LINE  
Point 1: Line to be trimmed  
Point 2: Line to trim against

The Trim One Line command can be used to trim a line to its intersection with another line. This command works with lines, circles, and arcs.

### Using the Command

Choose the TRIM ONE LINE command. Set a point on the line to be trimmed and a point on the line to be trimmed against. The first line is cut off at its intersection with the second. If the first line does not intersect the second, it is extended until they meet.

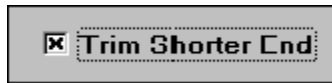

#### Trim Shorter End

- If you check this box, the shortest end of the line is always trimmed off. If this box is not checked, the part of the line that you set the first point on is kept, and the opposite end is removed.

Note: If you are in 2-D Mode, you can trim two lines that never meet by trimming their projections on the XY plane.

---

#### Example: Trim the short end of a line that intersects with another.

Select the TRIM ONE LINE command and click on the TRIM SHORTER END checkbox. Then set a point on the line that you want trimmed. DesignCAD trims the line back to its intersection with the other line.

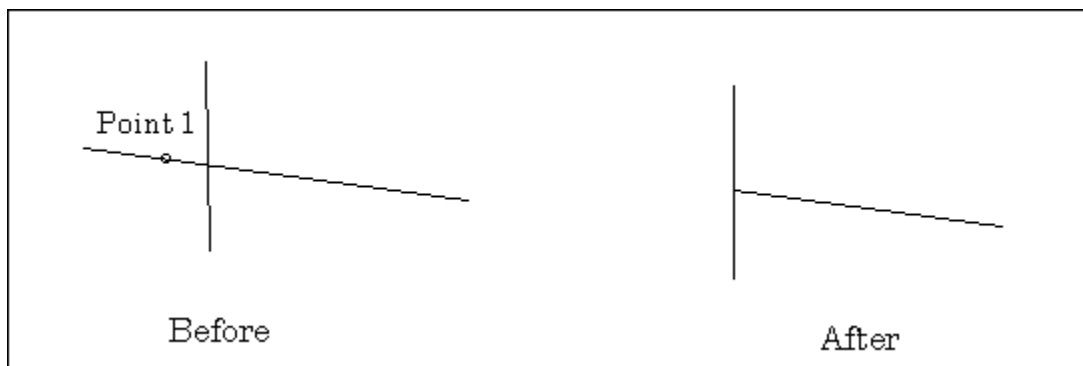

**See Also:** *Trim Two Lines Command*

Menu: EDIT  
Submenu: TRIM/EXTEND  
Menu Command: TRIM TWO LINES  
Point 1: First line to be trimmed  
Point 2: Second line to be trimmed

The Trim Two Lines command trims two lines at their intersection, forming a clean corner with no overlap. This command trims only lines and arc entities.

To use the Trim Two Lines command, set a point on each line to be trimmed. The lines will be cut off at their intersection. If the lines do not intersect, they will be extended to the point of intersection.



### Trim Shorter End

- If this box is checked, the shortest ends of the two lines will always be trimmed. If it is not checked, then place the points on the portions of the lines that you wish to keep, and the opposite ends will be trimmed away.

Note: If you are in 2-D Mode, you can trim two lines that never meet by trimming their projections on the XY plane. Of course, when you return to 3-D mode, they still don't meet.

---

### Example: Trim the short ends of two intersecting lines.

Select the TRIM TWO LINES command and click on the TRIM SHORTER END checkbox. Then set points on both lines. DesignCAD trims the lines back to their intersection.

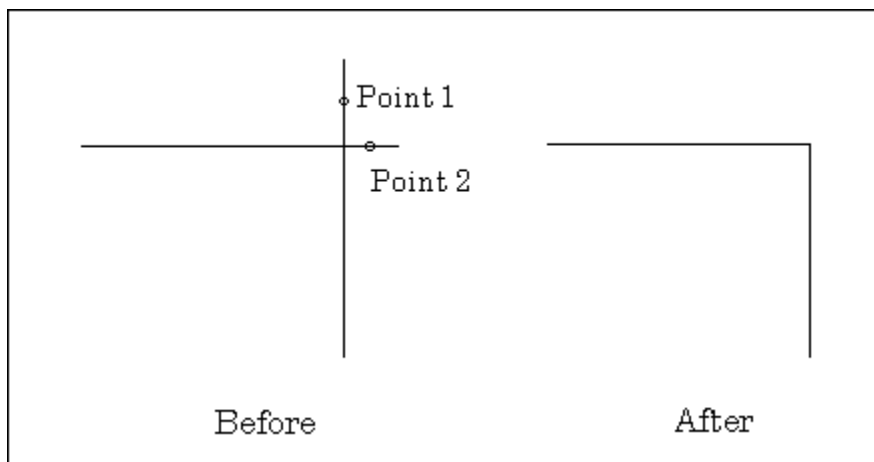

**See Also:** *Trim One Line Command*

Menu: SOLIDS  
Menu Command: TRUNCATED CONE



Toolbox Icon:

Point 1: Center of the base of the cone  
Point 2: Edge of the base of the cone  
Point 3: Height of the cone  
Point 4: Edge of the top of the cone

The Truncated Cone command draws a solid truncated cone.

### Using the Command

Set a point for the center of the base of the cone, a second point at the edge of the base, and a third point for the cone height. Next, move the cursor inward toward the center and set the fourth point for the edge of the truncated point of the cone.

You can specify the number of sides or facets around the cone in the NO. OF FACETS field in the Command Line.

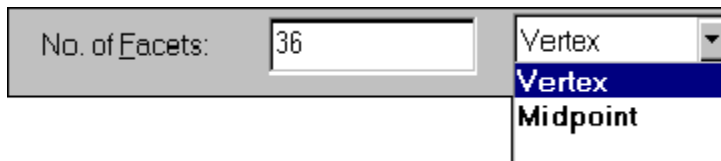

You can also choose whether the midpoint or vertex of the facets will be located at the radius defined by Points 2 and 4. If you choose VERTEX, the radius of the cone is inscribed by a circle of that radius. If you choose MIDPOINT, the radius of the cone circumscribes a circle of that radius. This is normally not significant, but it can be important for some precision drawings.

### Example: Draw a cone.

Select the TRUNCATED CONE command. Next set a point for the center of the base. Move the cursor out along the Y axis and set the second point for the radius of the cone. Now move the cursor up until the cone is the desired height and set the third point. Move the cursor back in along the Y axis and set the fourth point for the radius of the cone's truncated tip. The cone is inserted into the drawing.

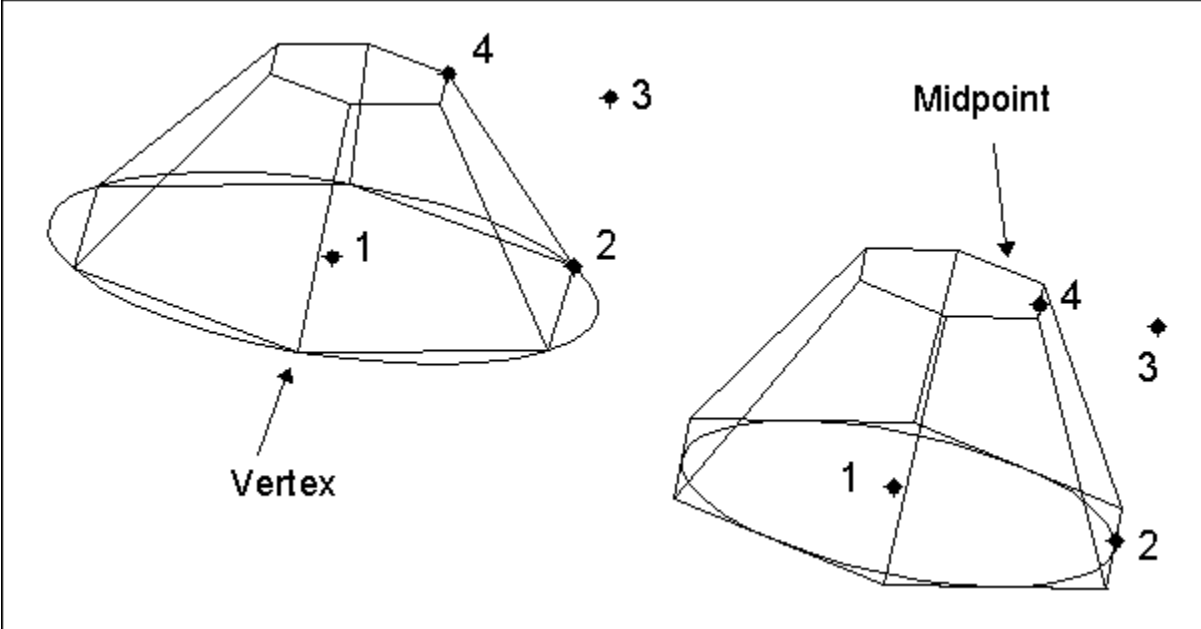

**See Also: Cone Command**

Menu: SOLIDS

Menu Command: TUBE



Toolbox Icon:

Point 1: Center of the tube

Point 2: Radius 1 (inner or outer)

Point 3: Length of the tube

Point 4: Radius 2 (outer or inner)

The Tube command draws a solid tube.

### Using the Command

You can specify the number of sides or facets around the tube in the NO. OF FACETS box in the Command Line.

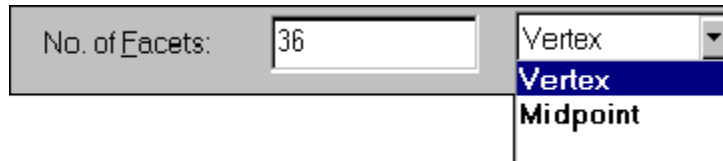

You can also choose whether the midpoint or vertex of the facets will be located at the radius defined by Point 2. If you choose VERTEX, the inner/outer radius of the tube is inscribed by a circle of that radius. If you choose MIDPOINT, the inner/outer radius of the tube circumscribes a circle of that radius.

### Example: Draw a tube in your drawing.

Select the TUBE command. Set a point for the center of the tube. Move the cursor along the Y axis and set the second point for the first radius of the tube; in this example, it will be the inner radius. Next, move the cursor up (or down) until the tube is the desired length, and set the third point. Move the cursor out along the Y axis again and set the fourth point for the second radius; in this example, it is the outer radius. The tube will be inserted into the drawing.

# The Tube Command

- 1-Center
- 2-Radius1 (inner or outer)
- 3-Length
- 4-Radius2 (outer or inner)

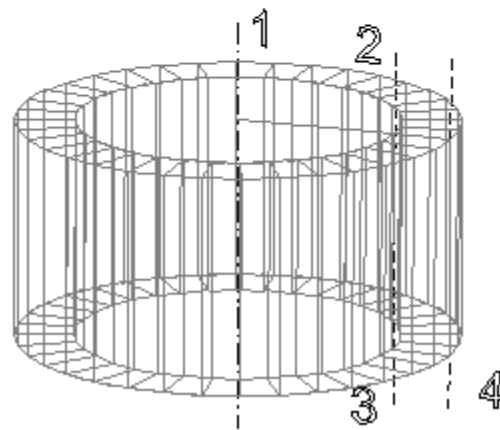
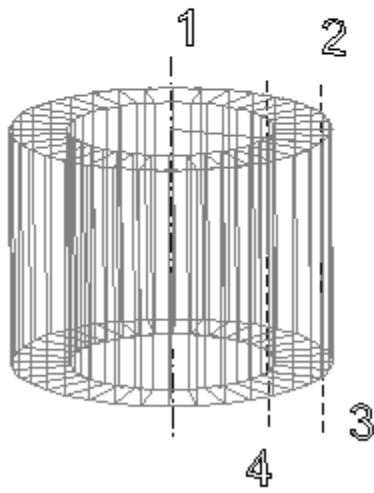

Menu: EDIT  
Menu Command: UNDO  
Toolbar Icon:   
Shortcut Key: **Ctrl + Z**

The Undo command cancels the most recent drawing action. It can be used repetitively to "back out" of a series of commands, as it is always negating the previous drawing action. You can "back up" to the point where the drawing was last saved.

***See Also: Redo Command***



Menu: DIMENSION  
Menu Command: UNITS  
Shortcut Key: **U**  
Point 1: First point on distance to measure.  
Point 2: Second point on distance to measure.

The Units command can be used to measure the distance between two points and, if you choose, to change the distance. This command can also be used to change the units of measurement in the drawing or to set up the initial drawing space.

### Using the Command

Choose the UNITS command. Set two points on the screen for a known distance. The Units box is displayed. You can accept the distance or change it in the THIS MEASURED DISTANCE IS box. Then click OK.

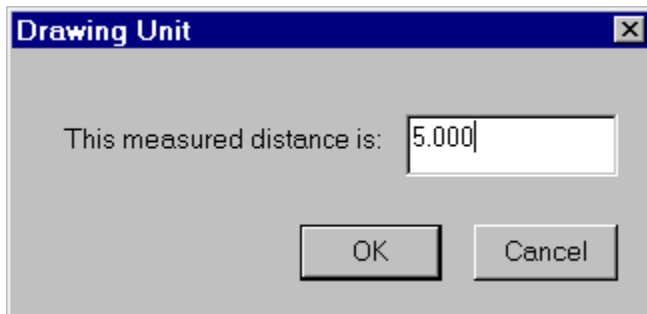

When you change the Drawing Units, it changes the entire coordinate system of the drawing, including any dynamic dimensions in the drawing.

### Example: Set your drawing screen so it is 100 Units wide.

After you have opened a new drawing, select the UNITS command. Set a point at the left edge of the screen and another at the right edge. Then enter **100** as the new measurement in the field in the UNITS dialog box.

Menu: EDIT  
Submenu: SELECTION  
Menu Command: VECTOR CONVERT

Point 1-n: Entities to be changed to line entities

The Vector Convert command converts selected entities such as arcs, circles, curves, and planes to vector entities.

### Using the Command

Select the entity to be converted. Choose VECTOR CONVERT. The entity is converted to a series of vectors, or short line segments. The new entity has more points than the original but looks the same.

#### Example: Convert a circle to vectors.

First, select the entity you want to convert to vectors. Now choose the VECTOR CONVERT command. DesignCAD automatically converts the entity to vectors. Although the entity does not change appearance, you can see the effect of conversion to vectors by choosing Point Select Mode and selecting the entity.

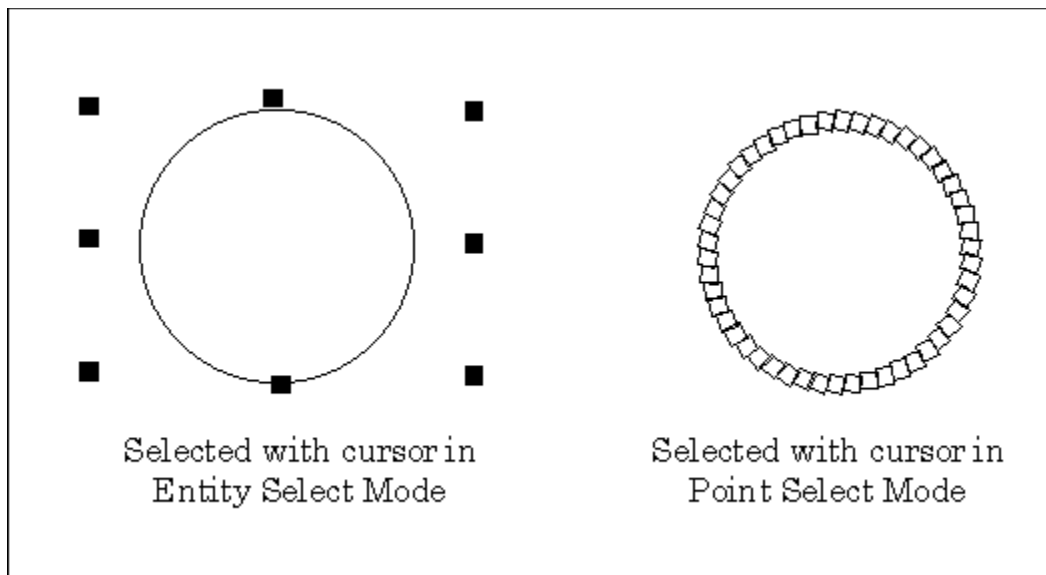

Menu: OPTIONS  
Menu Command: OPTIONS

The View Options folder allows you to choose which bars and toolboxes are displayed during the drawing session.

### Using the Command

Choose the OPTIONS command, and then click on the VIEW tab to bring up the View Options folder.

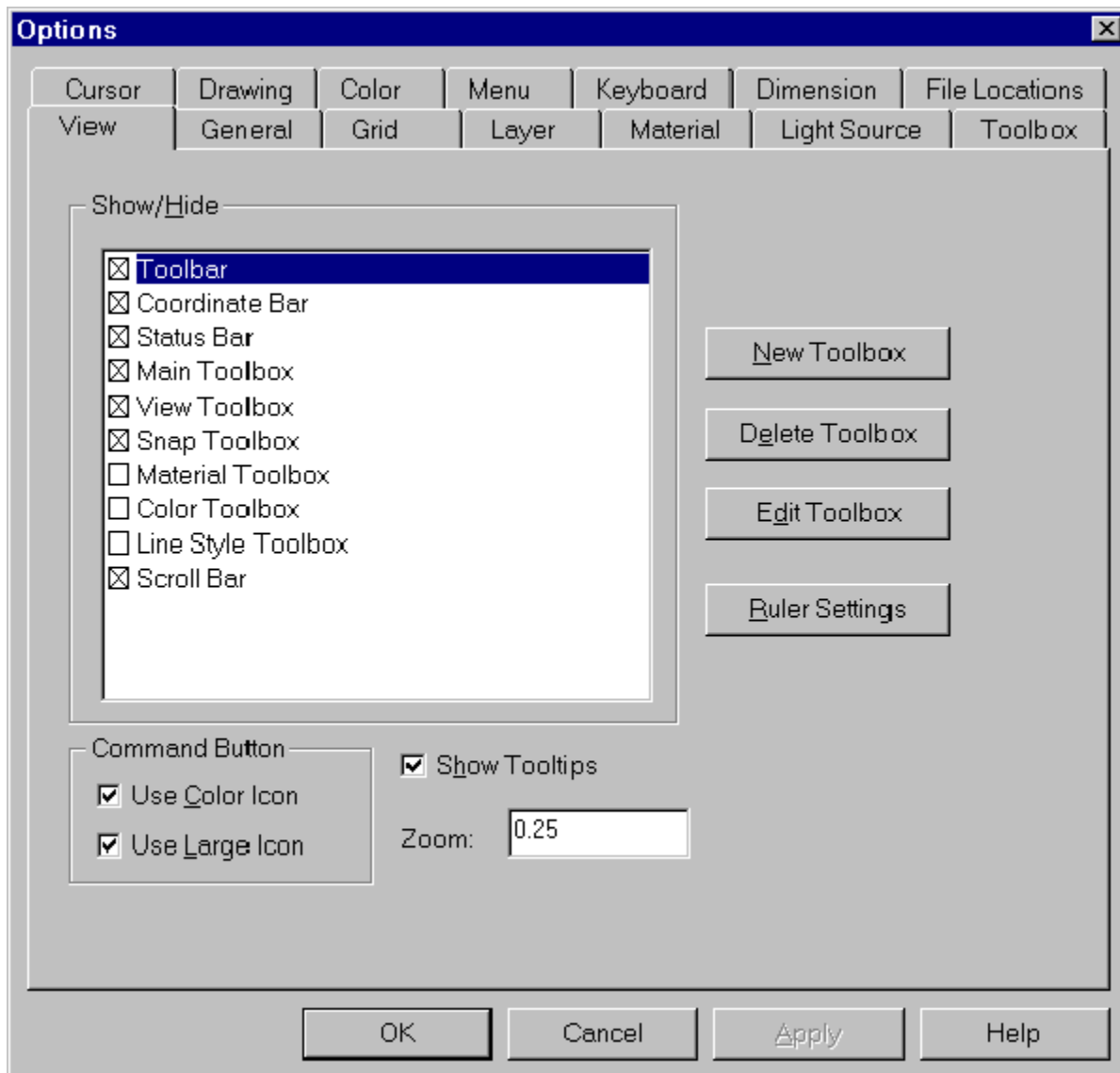

#### Show/Hide

- To activate a bar or toolbox, click the checkbox beside its name.

### New Toolbox

- This option creates a new Custom Toolbox. You may create as many as eight Custom Toolboxes. Each one may contain as many as 48 command, macro, or BasicCAD icons.

### Delete Toolbox

- Deletes a Custom Toolbox.

### Edit Toolbox

- This option brings up the TOOLBOX options folder, with the current toolbox selected. Only Custom Toolboxes can be edited.

### Ruler Settings

- This option brings up the Ruler Settings Dialog Box which allows you to set the ruler divisions.

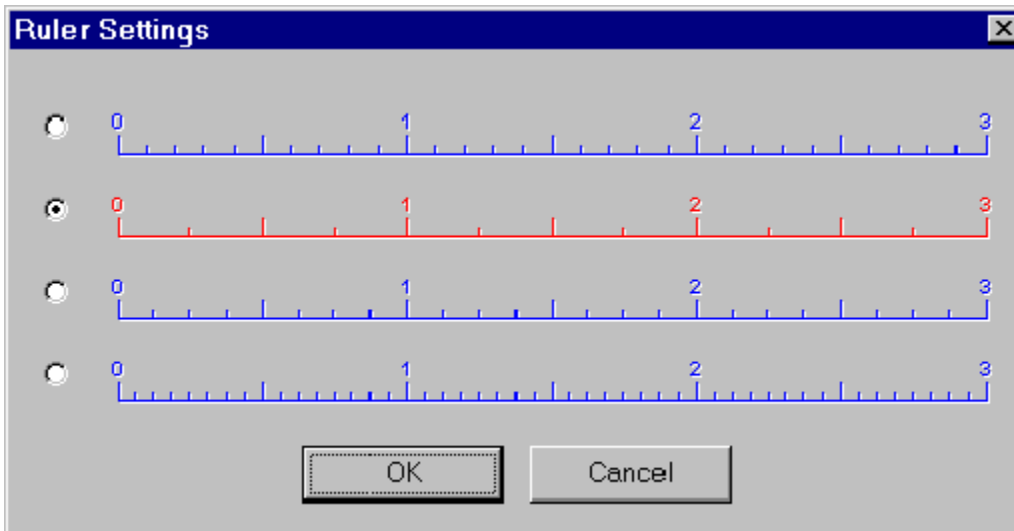

**Hint:** The Ruler Command, which displays or disables the ruler, is available under the View Command on the Main Menu. The ruler is available only in 2-D mode.

---

### Use Color Icon

- When this option is checked, icons are displayed in color. If this option is not checked, the option is disabled and the icons are displayed in grayscale.

### Use Large Icon

- When this option is checked, large icons are displayed. If this option is not checked, the option is disabled and small icons are displayed.

### Show Tooltips

- When this option is checked, tooltips are enabled. Use the mouse to move the cursor over an icon on the screen. The name of the command that is represented by that icon is displayed on the screen.

## Zoom

- This text field determines what zoom factor will be used for the Zoom commands. The default value is .25 (or 25 percent).

Menu: DIMENSION  
Menu Command: VOLUME  
Point 1: Object for which to calculate volume

The Volume command calculates the volume and surface area of a Solid object.

### Using the Command

Choose the Volume command, and then set a point on the Solid. DesignCAD does the rest!

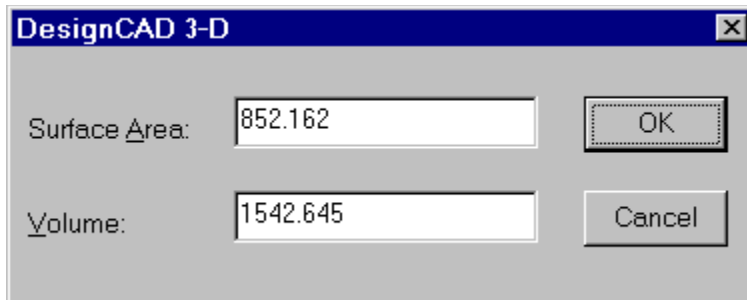

### Example: Determine the volume of an object in a drawing.

Select the VOLUME command and set a point on the object. DesignCAD displays the volume of the object in a dialog box, along with the surface area.

Menu: SOLIDS  
Menu Command: WALL  
Shortcut Key: [



Toolbox Icon:  
Point 1: First corner of wall  
Point 2: Opposite corner of wall

The Wall command draws a vertical wall of a specific thickness. It is useful when placing walls in a building model.

### Using the Command

Choose the WALL command. In the WALL THICKNESS box specify the thickness of the wall. Set a point for the first corner of the wall. As you move the cursor, a rubber-band box shows how the wall will be drawn. Set a second point for the opposite corner of the wall face. With the Wall command all you need do is draw a 2-d box, the thickness you enter in the Wall Thickness box is automatically added to the third direction.

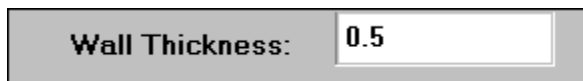

### Example: Draw a wall that is six inches thick.

For this example, assume that one Drawing Unit equals one foot. Select the WALL command. Enter .5 in the WALL THICKNESS box. Set a point the first corner. Move the cursor along the XY axis. A rubber-band wall appears, with the cursor location as Point 2. When the wall is the desired size, set a second point. Once the first wall is set, adjacent walls are easily added.

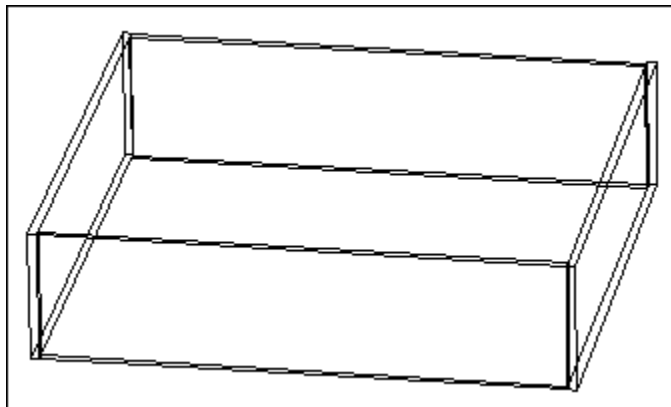

Menu: VIEW  
Menu Command: ZOOM

Toolbox Icon: 

Point 1: Center of zoom

The Zoom command makes the drawing appear larger or smaller on the screen. It does not affect the actual size or scale of the objects in the drawing unless you choose the RESET DRAWING SIZE option.

### Using the Command

Choose the Zoom command. In the Command Line set the ZOOM FACTOR and choose, if you want to change the actual drawing size, the RESET DRAWING SIZE box.

Zoom Factor: <input type="text" value="1.000"/>	<input type="checkbox"/> Reset drawing size
---	---

The zoom factor is relative to the current size of the drawing. If you zoom with a factor of two, the drawing appears twice as large. If you zoom with a factor of 0.25, the drawing is displayed at one fourth its current size.

If the RESET DRAWING SIZE box is checked, DesignCAD resizes the objects in the drawing according to the zoom factor. Otherwise, only the apparent size of the objects are changed.

### Example: Make your drawing two times larger.

Select the ZOOM command and enter 2 in the ZOOM FACTOR box. Set a point for the center of the zoom. The objects are redrawn, doubled in size.

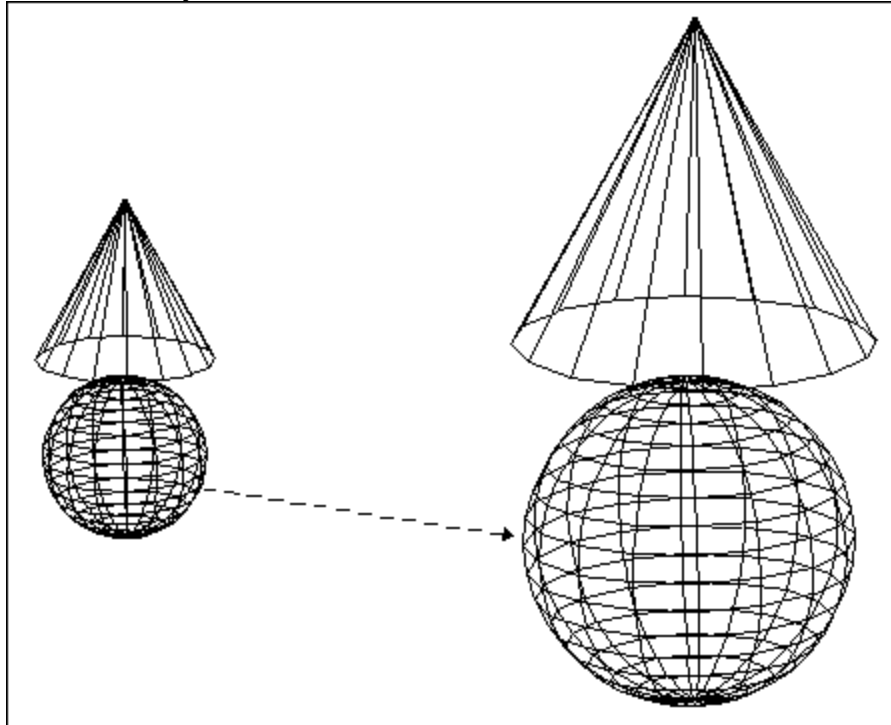





Menu: VIEW  
Menu Command: ZOOM IN  
Shortcut Key: +

Toolbox Icon: 

Point 1: Center of zoom

The Zoom In command give you a quick way to zoom into your drawing.

### Using the Command

Select the ZOOM IN command. Then position the cursor at the zoom center and click the left mouse button.

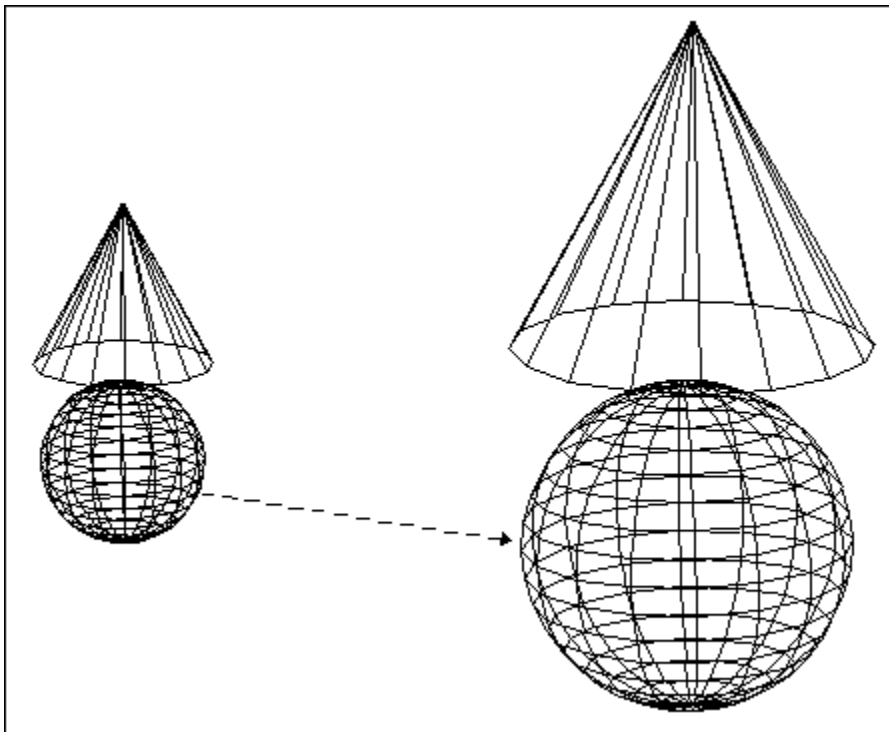

Menu: VIEW  
Menu Command: ZOOM OUT  
Shortcut Key: -

Toolbox Icon: 

Point 1: Center of zoom

The Zoom Out command gives you a quick way to zoom out, or reduce the size of the drawing as it appears on the screen.

### Using the Command

Select the ZOOM OUT command and position the cursor at the zoom center. Then click the left mouse button.

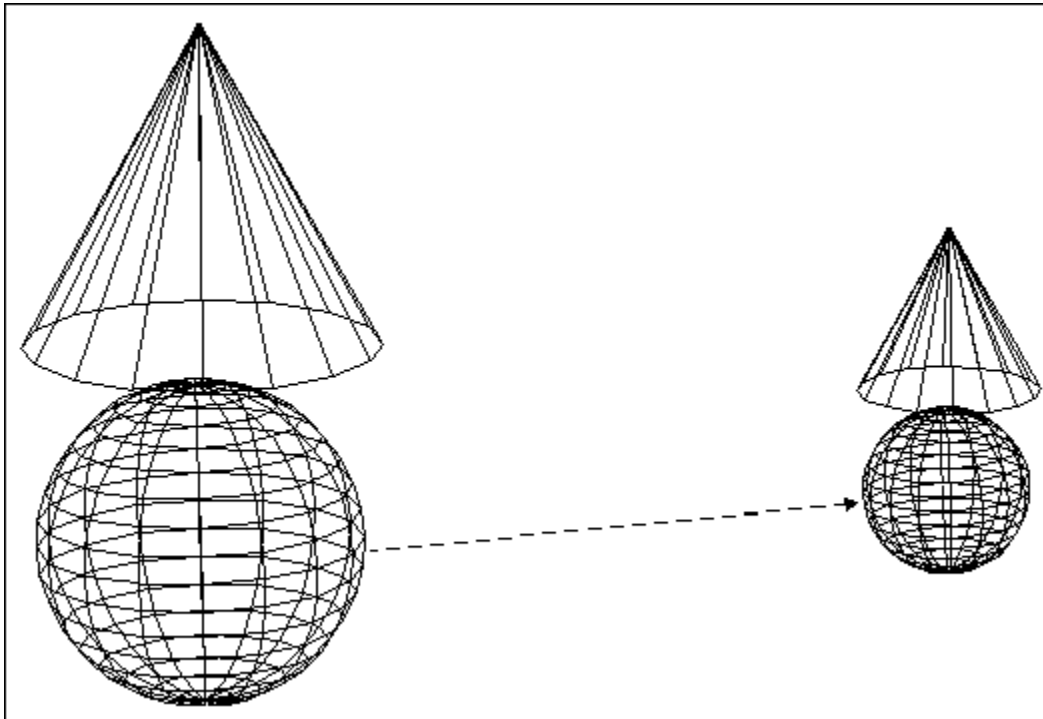

Menu: VIEW  
Menu Command: ZOOM PREVIOUS  
Shortcut Key: **Ctrl+M**

Toolbox Icon: 

The Zoom Previous command is used to revert instantly back to the zoom setting you used last. If you select this command repeatedly, it goes backwards through the entire sequence of zoom operations since the last time you saved the drawing.

### **Using the Command**

Choose the ZOOM PREVIOUS command. The view returns to the previous zoom factor.

***See Also: Zoom Command, Zoom In Command, Zoom Out Command, Zoom Window Command***

Menu: VIEW  
Menu Command: ZOOM REDO  
Shortcut Key: **Ctrl+Shift+M**

Toolbox Icon: 

The Zoom Redo command is used to revert to the last zoom setting before the Zoom Previous command. For example, if you change your mind about a zoom setting after using the Zoom Previous command, you can select the Zoom Redo command to cancel that zoom action.

### **Using the Command**

Choose the ZOOM REDO command. The view reverts to the view before the Zoom Previous command was used.

**Hint:** The Zoom Redo command is not available unless you have used the Zoom Previous command.

---

***See Also:*** [\*\*\*Zoom Previous Command\*\*\*](#)

Menu: VIEW  
Menu Command: ZOOM WINDOW  
Shortcut Key: Z

Toolbox Icon: 

Point 1: One corner of the area to be magnified  
Point 2: Opposite corner of the area to be magnified

The Zoom Window command zooms in on your drawing, filling the screen with a specified area of a drawing.

### Using the Command

Select the ZOOM WINDOW command. Drag a rectangle around the area you want to zoom into. That rectangle is then enlarged to fill the screen.

The Zoom Previous command can be used to zoom back to the previous size after you use the Zoom Window command.

### Example: Zoom in on an area of the screen.

Select the ZOOM WINDOW command. Set a point for one corner of the bounding box. As you move the cursor, a rubber-band bounding box is drawn using the cursor location as Point 2. When you set the second point, the area in the box is redrawn to fit the view window.

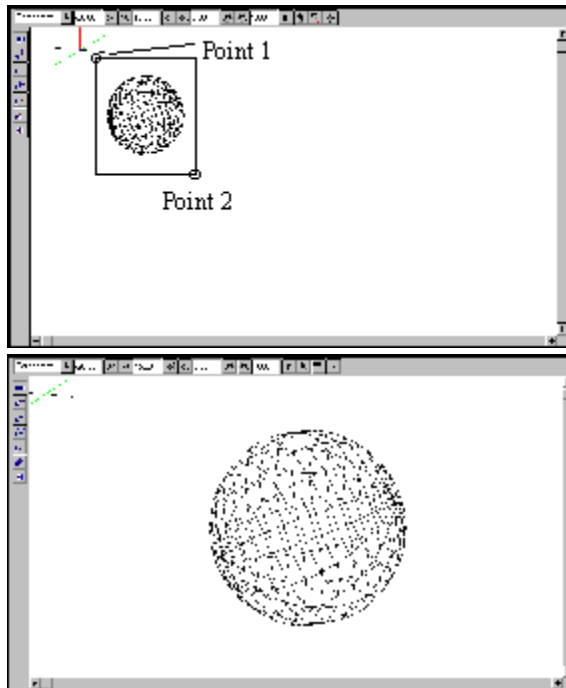

BasicCAD is a powerful programming language that allows you to run your own programs within DesignCAD 97. With BasicCAD, you can write a program and execute it as you would a DesignCAD 97 command.

The following pages describe the operation of BasicCAD, BasicCAD statements and built-in functions, and other information to help you write useful programs.

This documentation on BasicCAD assumes that you have at least a rudimentary knowledge of Basic programming. If you need an introduction to programming in Basic, a number of books are available through other sources.

[The Basics of BasicCAD](#)

[Usage Note](#)

[BasicCAD Statements](#)

[BasicCAD Built-In Functions](#)

[ENCRYPT-BasicCAD Program Encryption Utility](#)

[BasicCAD Limitations](#)

[BasicCAD Error Codes](#)

[BasicCAD Key Words](#)

BasicCAD is similar to standard Basic, but it provides the capability of executing DesignCAD macro commands as well as Basic statements.

To create a BasicCAD program, edit a file using a text editor and write the BasicCAD program. (The file extension should be .BSC.) To run the program, use the DesignCAD 97 Macro Execute command.

Try it—edit a file and enter the following program:

```
window 10, 30      ' open a text window 10x30
for j = 1 to 6     ' Print numbers 1-6 in the window.'

print j
next j
```

As with Quick Basic, BasicCAD uses the apostrophe (') for comments. The first statement above opens a text window on the screen 10 lines tall by 30 characters wide.

Statements two through four make up an ordinary FOR-NEXT loop that can be executed in any Basic language.

After you have entered the program, save it as "TEST.BSC." Be sure to save it in ASCII mode if you are using a word processor. The .BSC is the file extension used for BasicCAD programs. (.BSX is used for encrypted BasicCAD programs.)

Now start DesignCAD 97 and run the program by choosing the Macro Execute command.

Line numbers are not required or allowed in BasicCAD. A label can be used as the object of a GOTO or GOSUB statement.

There are two BasicCAD data types—numeric and string. The numeric data type is actually a real or floating point type. type.

BasicCAD variables and labels can be up to eight characters in length. They can consist of numbers and letters. They must begin with a letter. String variables must end with a dollar sign (\$). Any of the following are valid BasicCAD variable names:

```
J
TESTVAL
NAME$
```

There are certain words which BasicCAD reserves for its own use, and cannot be used as variable names. These are listed in the BasicCAD Keywords section of this Help file.

Any of the following are valid numeric constants:

```
45
45.4
```



2E3

(This is 2 \* 10 ^ 3)

Numeric expressions can contain the following operators: +, -, \*, /, \, MOD, and ^. (Like Microsoft Basic, \ performs integer division and MOD performs modular arithmetic – to find the remainder.) Parentheses are also allowed. The following are valid numeric expressions:

```
A * B + 4
A \ B + 4
A MOD 4
2 * 4 + 5          ( = 13)
2 * (4 + 5)        ( = 18)
2 * 3 ^ 2          ( = 18)
SQRT(4) + 4        (functions can be used in
                    expressions)
```

As with most programming languages, the operator precedence is:

1. ^
2. \*, /, \, MOD
3. +, -

String constants can be anything enclosed in quotes (" "):

```
"This is a string"
"4 * 8 is a string, if it is in quotes"
```

String variables and constants cannot be longer than 255 characters.

Logical expressions are used in DO and IF statements. Valid logical expressions can include relational operators (<, >, <>, =, <=, >=) and logical operators (AND, OR, NOT). As with most programming languages, the operator precedence is:

1. <, >, <>, =, <=, >=
2. NOT
3. AND
4. OR

Parentheses can be used in logical expressions. Some examples of logical expressions are:

```
B = 5
NOT B < 5 OR B = 7          true
NOT B < 5 AND B = 5         true
B <= 5 OR B > 5 AND B = 5   false
B <= 5 OR B > 5) AND B = 5  true
```

Comments are placed after an apostrophe (') anywhere on the line:

```
PRINT J ' A comment can go here
' or a comment can be on a line by itself
```

Comments should NOT be placed after DesignCAD macro commands or macro parameters, however:

```
>Sphere    'DO NOT PUT COMMENTS HERE
{
           <color 255,0,0           'OR HERE
}
```

DesignCAD macro commands and parameters are easily distinguished from BasicCAD statements. All DesignCAD macro commands have a ">" at the beginning of the line, and all macro parameters have a "<" at the beginning of the line. Do not put comments in these lines.

PROBLEMS? We've made BasicCAD as easy to use and understand as possible. However, we can't help debug BasicCAD programs over the telephone. If you have a specific question or problem with BasicCAD, please mail us a copy of the BasicCAD program on a disk, along with a description of the problem. We will respond as soon as possible. You can also contact the DesignCAD BBS for BasicCAD support: (918) 825-4878.

A note on usage in this section:

Statement	Refers to a BasicCAD statement. See "BasicCAD Statements" for a description of these.
Function	Refers to a BasicCAD function, such as SIN(x) or SYS(32). See "BasicCAD Built-in Functions" for a description of these.
Macro Command	Refers to a DesignCAD 97 for Windows drawing command, such as Line or Hatch. The DesignCAD 97 macro commands are listed in "DesignCAD 97 Command List."
Macro Parameter	Refers to an argument necessary for a DesignCAD 97 command. Parameters may be numerical values or strings, and variables can be substituted for constants. The DesignCAD 97 macro parameters are listed after the macro commands. in "DesignCAD 97 Command List."

The following pages describe the BasicCAD statements. They are listed in alphabetical order.

The purpose of each statement is described, along with its syntax. An explanation and example of each statement is also provided.

[Assignment Statement](#)

[ANYKEY Statement](#)

[CHAIN Statement](#)

[CLEAR Statement](#)

[CLOSE Statement](#)

[CLS Statement](#)

[COLOR Statement](#)

[DIM Statement](#)

[DO WHILE and LOOP Statements](#)

[END Statement](#)

[ENTITY Statement](#)

[EXIT DO Statement](#)

[EXIT FOR Statement](#)

[FOR and NEXT Statements](#)

[GET Statement](#)

[GETATTR Statement](#)

[GETSELECT Statement](#)

[GETXY Statement](#)

[GOSUB and RETURN Statements](#)

[GOTO Statement](#)

[IF Statement \(single line\)](#)

[IF Statement \(Group IF\)](#)

[INPUT Statement](#)

[INPUT # Statement](#)

[LABELS](#)

[LAYER Statement](#)

[LOCATE Statement](#)

[MESSAGE Statement](#)

[ON ERROR Statement](#)

[OPEN Statement](#)

[POINTVAL Statement](#)

[PRECISION Statement](#)

[PRINT Statement](#)

[PRINT # Statement](#)

[PUT Statement](#)

[PUTATTR Statement](#)

[RESUME Statement](#)

[RUN Statement](#)

SETPOINT Statement

STOP Statement

TAB Statement

WCLOSE Statement

WINDOW Statement

**PURPOSE:**

To assign a value to a numeric variable.

**SYNTAX:**

*variable = expression*  
*stringvar = expressionlist*

**EXPLANATION:**

"*Variable*" can be any numeric variable name. "*Expression*" can be any valid numeric expression.

"*Stringvar*" is any valid string variable name. "*Expressionlist*" is one or more string or numeric expressions separated by commas. Numeric expressions can be assigned to a string – they are evaluated and converted to ASCII format. Using more than one expression allows you to concatenate strings.

**EXAMPLES:**

```
x = sin(t) + 3 * j ^ 2
xpos = xpos + 1
z=sqr(var(2))
xp(j) = xp(k) * 2
a$ = "This is a test"
j = 23
b$ = "the answer is ", j
' b$ is "the answer is 23"
a1$ = "1234"
a2$ = "5678"
a3$ = a$, b$           ' a3$ is "12345678"
```

**PURPOSE:**

To wait for a single key press.

**SYNTAX:**

ANYKEY {*variable*}

**EXPLANATION:**

The ANYKEY statement waits for and reads keystrokes from the keyboard. This statement can be used with or without a variable. If a variable is used, then the value of the key pressed is assigned to that variable. String variables or numeric variables can be used. If a numeric variable is used, the ASCII code of the keystroke is assigned to the variable. Pressing a mouse button will act as a keystroke, but will assign no value to the variable in the ANYKEY statement.

This statement is useful if you want to pause for a key press after printing to the bottom of the screen or to a text window.

**EXAMPLE:**

```
ANYKEY  
ANYKEY A$ ' Read a keystroke into A$  
ANYKEY KEY      ' Read a keystroke into KEY
```

**PURPOSE:**

To transfer control to another BasicCAD program.

**SYNTAX:**

CHAIN *programname*

**EXPLANATION:**

This statement is used to run another BasicCAD program, leaving all the variables from the current program intact when the other program is executed. A string variable or constant can be used for the program name.

The CHAIN statement causes the new program (*programname*) to replace the current program in memory. To return to the original program, you must execute another CHAIN or RUN statement from the new program. The execution of a program called by the CHAIN statement always begins at the first line in the called program.

The RUN statement is similar to the CHAIN statement, but the RUN statement clears all variables before executing the new program.

**Note:** If you use a CHAIN statement that calls an encrypted (.BSX) BasicCAD program, you must specify the filename complete with its .BSX extension.

**EXAMPLE:**

```
CHAIN PGMNAME$  
CHAIN "TEST1"  
CHAIN "SECRET.BSX"
```



**PURPOSE:**

To erase all variables in the program.

**SYNTAX:**

CLEAR

**EXPLANATION:**

This statement is used to erase and de-allocate all variables in the program. It can be used to free memory or to re-initialize variables.

**EXAMPLE:**

```
CLEAR
```

**PURPOSE:**

To close a disk file.

**SYNTAX:**

CLOSE { *filenumber* }

**EXPLANATION:**

This statement is used with the OPEN statement. If a disk file has been opened for input or output, it should be closed after being used. *Filenumber* is the number of the file to be closed. If it is omitted, all open files will be closed.

A disk file left open when the program ends is automatically closed. However, the CLOSE statement must be used to close an open file before that file number is used again.

**EXAMPLE:**

```
CLOSE 1
```

**PURPOSE:**

Clear a text window.

**SYNTAX:**

CLS

**EXPLANATION:**

The CLS statement clears all the text inside the text window. If a text window is not open, this statement has no effect. See the WINDOW statement for more information on text windows.

**EXAMPLE:**

```
window 5, 30      ' open a window 5 lines x 30 chars.  
print "press any key to continue..."  
anykey           ' move to column 20  
cls              ' clear the text window
```

**PURPOSE:**

Set the text color in a text window.

**SYNTAX:**

COLOR *foreground* {, *background*}

**EXPLANATION:**

This statement is used to set the color of text in a text window.

*Foreground* is the foreground color for the text, and *background* is the background color. The colors can range from zero to 19. These numbers correspond to the standard Windows palette, not to DCW's palette.

The COLOR statement affects only the text displayed with PRINT statements after the COLOR statement is executed. The text color remains set at the specified color until the next COLOR statement is executed.

**EXAMPLE:**

```
precision 0          ' print numbers as integers
window 20, 30      ' open a window 20 lines x 30 chars.
for i = 0 to 19    ' start a loop to change the
                  ' foreground color
color 0,i          ' foreground 0, background i
print "this is a test of color", i
next i
anykey
```

**PURPOSE:**

To specify the size of one or more arrays.

**SYNTAX:**

`DIM variable(expression) {, variable(expression)...}`

**EXPLANATION:**

The DIM statement is used to allocate storage for arrays. An array is a single variable with several elements, addressed with a subscript in parentheses such as: `A(20)` .

An array must be dimensioned before it is used. Any numeric expression can be used for the array size. String arrays are allowed. All arrays are one-dimensional – that is, an array can have only one subscript.

An array cannot be re-dimensioned. A DIM statement must be executed only once. A variable array must be dimensioned before the variable is used.

**EXAMPLES:**

```
dim a(10)

dim jx(200), jy(200)

dim a$(20)

n = 15
dim point(n)
```

**PURPOSE:**

To execute a series of instructions in a loop.

**SYNTAX:**

DO WHILE *logexpression*

.  
. .  
. . .

LOOP

**EXPLANATION:**

The DO WHILE statement is used to start a loop that will be executed as long as the logical expression "*logexpression*" is true. When the LOOP statement is encountered, program execution is transferred back to the DO WHILE statement and the logical expression is checked again. When the expression is false, execution continues after the LOOP statement.

The logical expression consists of one or more relational expressions separated by AND or OR. A logical expression can also be preceded by NOT.

A relational expression consists of two numeric or string expressions separated by one of the following relational operators: <, <=, =, >=, >, <>.

When using a DO loop, be sure the logical expression will eventually change to false, or the loop will never end. (Any BasicCAD program can be terminated by pressing the **Esc** key, however.)

DO WHILE loops can be nested up to eight levels deep.

**EXAMPLE:**

```
j = 1
do while j < 20
  print j
  j = j * 2
loop
print "done"

prints:  1.000
        2.000
```

4.000

8.000

16.000

done

**PURPOSE:**

To terminate the program and return to DesignCAD 97.

**SYNTAX:**

END

**EXPLANATION:**

The END statement can be placed anywhere in the program. An END statement at the end of the program is optional. This statement is the same as the STOP statement.

**EXAMPLE:**

```
if i > max then end
```



**PURPOSE:**

To access an entity in the drawing by entity number.

**SYNTAX:**

ENTITY *expression*

**EXPLANATION:**

The ENTITY statement is used to read an entity into the SYS function variables 90-99. The entity is accessed by entity number – the arbitrary order in which the entity was placed in memory. This makes it possible to process all entities in the drawing. The Entity statement also places all of the entity's points into memory (as if the user had set the points manually) so that they can be accessed by POINTVAL.

Note that for Grid entities, entity type 32, sys (99) represents not the number of points, but the number of individual Grid Line entities (type 33) to follow. For each Grid Line, sys (99) retains its normal meaning.

**EXAMPLE:**

```
' count the number of circle entities in layer 20
' sys(9) is the number of entities in the drawing
n = 0
for j = 1 to sys(9)
  entity j
  ' sys(93) = layer, and sys(90) = entity type
  if sys(93) = 20 and sys(90) = 16 then n = n + 1
next j
message "number of circles: ", n
```

**PURPOSE:**

To exit a DO loop prematurely.

**SYNTAX:**

EXIT DO

**EXPLANATION:**

The EXIT DO statement can be used to exit a DO loop from anywhere within the loop. This makes it easy to exit a DO loop without using a label and a GOTO statement.

**EXAMPLE:**

```
do while i < 1000
  anykey keycode
  if keycode = 27 then exit do
  .
  .
loop
```

**PURPOSE:**

To exit a FOR-NEXT loop prematurely.

**SYNTAX:**

EXIT FOR

**EXPLANATION:**

The EXIT FOR statement can be used to exit a FOR-NEXT loop from anywhere within the loop. This makes it easy to exit a FOR-NEXT loop without using a label and a GOTO statement.

**EXAMPLE:**

```
for j = 1 to 100
  anykey keycode
  if keycode = 27 then exit for
  .
  .
next
```



```
for j = 2 to 1
  print "this will not be printed"
next
```

**PURPOSE:**

To read a record from a random access file

**SYNTAX:**

GET *file*, *recordnumber*, *stringvar*

**EXPLANATION:**

This statement is used to read a record from a random access file. The record length is specified in the OPEN statement.

When the GET statement is executed, the designated record (*recordnumber*) of the file will be read into the string variable (*stringvar*). The MKS\$ and the CVS functions can be used to convert numeric values to and from four-byte strings for file input and output.

**EXAMPLE:**

```
open "r," 1, "test.dat," 80
for j = 1 to 10
  input "Enter the record number: ", recno
  get 1, recno, a$      ' get record recno
  print right$(a$, 20) ' print the last 20 bytes
next j
```

## PURPOSE:

To get entity type, group status, and layer of an entity.

## SYNTAX:

GETATTR *entity*, *type* {*,select, layer, group, red, green, blue, solid*}

("Solid" represents the identifying number of the solid of which the entity is a part. If the entity is not part of a solid, then *solid* returns zero.)

## EXPLANATION:

This statement is used to get the entity type, group status, and layer of an entity. *Entity* is the entity number – one for the first entity in the drawing, two for the second, etc. *Type* is the entity type, as shown:

- 1 = Line
- 2 = Ellipse
- 3 = Text
- 4 = Curve
- 7 = Elliptical Arc
- 11 = Bezier Curve
- 15 = Attribute
- 16 = Circle, Circular Arc
- 17 = Hatch
- 21 = New Layer
- 22 = Text Arc
- 23 = Layer Names
- 24 = Arrow
- 26 = Symbol
- 31 = Plane
- 32 = Grid
- 33 = Grid Line
- 70 = Point Mark
- 74 = Dimension, Angle
- 75 = Dimension
- 76 = Dimension, Diameter/Radius
- 77 = Dimension, Arc
- 78 = Dimension, Radius Progressive
- 79 = Dimension, Progressive
- 80 = Dimension, Chamfer
- 81 = Dimension, Coordinate
- 90 = Bitmap Image

Note that not all of these types can be created in DesignCAD 97. They are included, nevertheless, because they may be encountered in drawings which were created using DesignCAD 2D.

*Select* is zero if the entity is not selected, or one if the entity is currently selected. *Layer* is the

layer number of the entity. *Group* is the group ID number if the entity is part of a Group, or zero otherwise. *Red, green, and blue* are the color components of the entity's color.

*Type, select, layer, group, red, green, and blue* must be BasicCAD variables, not expressions, since they will be assigned values.

**EXAMPLE:**

```
'Get total length of all lines in the drawing.
l = 0
for j = 1 to sys(9)
    'sys(9) is the number of entities
    getattr j, type, group, layr
    if type = 1 then l = l + length(j)
next
message "The length is ", l
```



**PURPOSE:**

To get the entity number(s) of the currently selected entity(s)

**SYNTAX:**

GETSELECT *expression, variable*

**EXPLANATION:**

This statement can be used to retrieve entity numbers of selected items so these items can be investigated with the ENTITY statement, if desired, or information about the entities can be retrieved with GETATTR and changed with PUTATTR. "*Expression*" is a number, variable, or mathematical expression evaluating to an integer; this number determines which of the selected entities you want the entity number for. "*Variable*" is the name of the variable you want to store the entity number in.

GETSELECT will ignore any selection status changes made by the PUTATTR statement. Entities must have been selected by the DesignCAD Select command, either earlier in the BasicCAD program or before you ran the program.

**EXAMPLE:** (assumes you have already selected as many as ten items before running the program)

```
dim ent(10)                'set up an array for entity numbers
maxsel=(sys(80)*(sys(80)<10)) + (10*(sys(80)>=10))
window 10,40
for j = 1 to maxsel
  getselect j, ent(j) 'get info for selected items
  print "Picked item ",j, " is entity ", ent(j)
  next j              'go to the next item
anykey
```

**PURPOSE:**

To get the X, Y, Z coordinates of the current cursor position

**SYNTAX:**

GETXY *variable variable variable*

**EXPLANATION:**

This statement can be used to assign the X, Y, Z coordinates of the current cursor position to three variables. It is very useful in getting the "current" position to provide a reference location for the rest of the program.

**EXAMPLE:**

```
getxy x1 y1 z1
>line
{
for j = 0 to 360 step 45
  x = x1 + cos(j) * 10
  y = y1 - sin(j) * 10
  <pointxyz [x, y, z1]
next j
}
```

**PURPOSE:**

To call a subroutine.

**SYNTAX:**

GOSUB *label*

RETURN

**EXPLANATION:**

The GOSUB statement is used to transfer program execution to another statement out of the normal sequence of execution. This statement resumes execution after the GOSUB statement when a RETURN statement is encountered – it calls a subroutine. "*Label*" can be any valid BasicCAD label. A RETURN statement must be used to return from a subroutine called by a GOSUB statement.

**EXAMPLE:**

```
x = 20
y = 20
gosub rotate
>line
{
<pointxyz [gx1, gy1, gz1]
<pointxyz [x1, y1, gz1]
}
.
.
rotate:
x1 = gx1 + sine * x + cosine * y
y1 = gy1 - cosine * x + sine * y
return
```

**PURPOSE:**

To branch to another statement.

**SYNTAX:**

GOTO *label*

**EXPLANATION:**

This statement is used to transfer program execution to another statement out of the normal sequence of execution. "*Label*" can be any valid BasicCAD label.

**EXAMPLE:**

```
retry:
  input "enter a number less than 20: ", x
  if x >= 20 then goto retry
```

**PURPOSE:**

To execute a BasicCAD statement under certain conditions.

**SYNTAX:**

IF *logexpression* THEN *statement*

**EXPLANATION:**

"*Logexpression*" is a logical expression that can be answered true or false. If the expression is true, then the "*statement*" is executed; otherwise, it is not.

The logical expression consists of one or more relational expressions separated by AND or OR. A logical expression can also be preceded by NOT.

A relational expression consists of two numeric or string expressions separated by one of the following relational operators: <, <=, =, >=, >, <>.

**EXAMPLES:**

```
if eof(1) <> 0 then end
```

```
retry:  
  input "enter a number less than 20: ", x  
  if x >= 20 then goto retry
```

```
if a$ = "y" then goto affirm
```

**PURPOSE:**

To execute a set of BasicCAD statements under certain conditions.

**SYNTAX:**

IF *logexpression* THEN

statements

.

.

{ ELSE

statements

.

.}

END IF

**EXPLANATION:**

"*Logexpression*" is a logical expression that can be answered true or false. If the expression is true, then the first set of statements is executed, otherwise the second set is executed. The ELSE section is optional, but the END IF is required.

The logical expression consists of one or more relational expressions separated by AND or OR. A logical expression can also be preceded by NOT.

A relational expression consists of two numeric or string expressions separated by one of the following relational operators: <, <=, =, >=, >, <>.

With the Group IF statement, the IF statement line must end with the word "THEN" (except for comments). In contrast, the single-statement IF must have the conditionally executed statement following the word "THEN" on the same line.

**EXAMPLES:**

```
if eof(1) <> 0 then
  print "end-of-file was encountered."
  end          ' stop the program
end if
```

```
if j > 90 then
```

```
    print "j is too large: ", j
else
    x = sin(j) * l
    y = y + 1
end if
```

# INPUT Statement

## PURPOSE:

To read a value from the keyboard and assign it to a variable.

## SYNTAX:

INPUT *string*, *variable list*

INPUT *variable list*

## EXPLANATION:

The INPUT statement is used to ask the user for input and assign the entered value to a variable. "*String*" is an optional message to be displayed for the user. "*Variable list*" is one or more variables, separated by commas, to which the input values are to be assigned.

If a single string variable is used, the entire string input from the keyboard is assigned to the variable.

If numeric variables are used, the numbers input from the keyboard are assigned to the corresponding variables.

If more than one variable is used with the INPUT statement, any strings input should be enclosed in quotes ("").

Values read with the INPUT statement can be any valid BasicCAD expressions – they do not have to be simple constants. For example, the user can enter **SQRT(2)** or **45/2** when a number is requested.

## EXAMPLES:

```
input "Enter the initial value: ", init
```

```
input "Enter the input file name: ", file$  
open "i", 1, file$
```

```
input "Enter the coordinates: ", x, y, z
```



**PURPOSE:**

To read a line from a disk file and assign it to a variable.

**SYNTAX:**

INPUT #*file*, *variablelist*

**EXPLANATION:**

This statement is used to read a line from a disk file and assign it to a numeric variable or to a string variable. The INPUT statement reads an entire line from the disk file. *File* is the file number that was used in the OPEN statement. *Variablelist* is a set of one or more variables separated by commas. The variables can be string or numeric variables.

When this statement is executed, a line from the file is read and a value is assigned to each variable. If the line from the file has fewer values than there are variables, the leftover variables are not modified.

String values in the file should be enclosed in quotes if there are multiple values on a line. If an entire line from the file is to be read into a single string variable, use a single string variable with the INPUT # statement.

Values read can be any valid BasicCAD expressions – they do not have to be simple constants.

The file must have been opened using the OPEN statement before the INPUT # statement is executed. The BasicCAD function EOF(file) can be used to determine whether the end-of-file has been reached.

**EXAMPLES:**

```
for j = 1 to 20
  input #1, jx(j), jy(j)
next
input #1, name$
```

```
open "i", 2, "testfile"
do while eof(1) = 0
  input #2, a$
  print a$
loop
```

**PURPOSE:**

To provide a reference to locations in the program for GOTO or RESUME statements.

**SYNTAX:**

*label:*

**EXPLANATION:**

"*Label*" can be up to seven characters long, may consist of letters and numbers, and must begin with a letter. A BasicCAD statement can optionally follow a label on a line.

**EXAMPLE:**

```
retry: ' this is a label
      input "Enter a number less than 20: ", x
      if x >= 20 then goto retry
```

**PURPOSE:**

To turn drawing layers on or off, and to set the current layer.

**SYNTAX:**

LAYER(*expression*) = *expression*

**EXPLANATION:**

The LAYER statement can be used to set a layer to be visible/invisible or editable/uneditable. It can also be used to set the current layer. The following values can be used with the LAYER statement:

- 0 – Invisible and not editable
- 2 – Visible but not editable
- 6 – Visible and editable
- 14 – Set as current layer

The first *expression* is the layer number, and the second expression must be one of the above values. The LAYER function can be used to get the current status of a layer. See the BasicCAD function descriptions in this Help file.

The DesignCAD >Regenerate command should be used to regenerate the drawing if the visibility of layers has been changed. Otherwise, entities from invisible layers may remain on the screen. Entities from visible layers may not appear on the screen.

If you have used PUTATTR to change the layer of an item, you must use the LAYER statement to reset the current layer in order for the layer info in the coordinate bar to display correctly. You can use:

```
layer(sys(3)) = 14  
'this updates the layer information in the 'drawing.
```

**EXAMPLES:**

```
layer(1) = 14 ' set the current layer to layer 1
```

```
for j = 0 to 255 ' make all visible and editable  
  layer(j) = 6  
next j
```

**PURPOSE:**

To position the cursor in a text window.

**SYNTAX:**

LOCATE *row, column*

**EXPLANATION:**

The LOCATE statement positions the cursor in the text window that was opened by the WINDOW statement. The next PRINT statement will begin at the specified row and column.

This statement has no effect if a text window is not open.

**EXAMPLE:**

```
window 7, 40
locate 3, 9
print "centered in the window"
anykey
```

**PURPOSE:**

To output data to the screen.

**SYNTAX:**

MESSAGE { *list of expressions* }

**EXPLANATION:**

The MESSAGE statement is used to output numeric and/or string expressions to the DesignCAD screen. It is similar to the PRINT statement, except that a dialog box is opened for each message statement. The program pauses until the user presses the OK button. This command uses the Windows Message Box function.

If more than one line is to be output, `chr$(13)` can be included in the output expressions.

**EXAMPLES:**

```
message j, " is the current value."  
message "x: ", x, chr$(13), "y: ", y  
'(This puts x and y on separate lines in the same 'message box.)
```

**PURPOSE:**

To set up an error handling routine.

**SYNTAX:**

ON ERROR GOTO *label*

**EXPLANATION:**

After the ON ERROR statement has been executed, any BasicCAD error will cause the execution to be transferred to the specified label. Program execution will continue until a RESUME statement is encountered.

This statement is used to trap errors in a program. The ERR function can be used to determine the error code. See the RESUME statement.

**EXAMPLE:**

```
on error goto handler
  open "i", 1, "-----"    ' invalid file name
  print "No Error"         ' this won't be printed

cont:
  print "Program Done"     ' second line printed
  end

handler:
  print "Error: ", err(1)  ' first line printed
  resume cont
```

**PURPOSE:**

To open a file for input or output for the INPUT #, PRINT #, GET, or PUT statements.

**SYNTAX:**

OPEN "A", *filenumber*, *filename*

OPEN "I", *filenumber*, *filename*

OPEN "O", *filenumber*, *filename*

OPEN "R", *filenumber*, *filename*, *recordlength*

**EXPLANATION:**

A file must be opened before it is accessed by the INPUT # or PRINT # statements. To open a file for sequential input, use the "I" parameter before the file name. To open a file for sequential output, use "O." (This is the letter O, not the number zero.) You can use "A" to append data to a file – this is like "O", but if the file exists, data will be output to the end of the file.

To open a file for random access (for GET and PUT), use "R." If random access is specified, then the record length must also be specified. This value represents the number of bytes that will be read or written with the GET and PUT statements.

LPT1 can be specified for the file name in order to output to the printer. However, LPT1 can be used only for output, with OPEN "O."

The *filenumber* can be one to four. Up to four files can be opened at one time. *Filename* can be any valid DOS file name, including the path.

**EXAMPLES:**

```
open "o", 1, "outfile"
```

```
input "Enter the input file name: ", file$  
open "i", 1, file$  
open "r", k, file$, 80
```

**PURPOSE:**

To assign the coordinates of one of the points that has been set to two variables.

**SYNTAX:**

POINTVAL *variable variable variable expression*

**EXPLANATION:**

The three "*variables*" will be assigned the X, Y, and Z coordinates of the point that has been set in DesignCAD. The "*expression*" determines which point will be assigned to the variables. The number of points currently set can be determined in the system function SYS(1). An error will occur if *expression* is greater than the number of points set in SYS(1).

**EXAMPLES:**

```
pointval x y z 1 ' coordinates of first point
```

```
' get all points into jx, jy, jz  
for j = 1 to sys(1)  
  pointval jx(j) jy(j) jz(j) j  
next j
```



**PURPOSE:**

To set the precision for PRINT statements and for numeric-to-string conversions.

**SYNTAX:**

PRECISION *expression*

**EXPLANATION:**

The PRECISION statement determines the number of digits to the right of the decimal point to be used in PRINT statements and in numeric-to-string conversions.

For example, a precision of zero can be used to print or assign only whole numbers. A precision of four can be used to print numbers to the nearest .0001.

The PRECISION statement affects only the conversion of an expression – it does not affect the value of a numeric variable.

The precision remains the same until it is changed again by the PRECISION statement.

**EXAMPLE:**

```
x = 44.123456789
precision 0
print x * 2          ' prints "88"

precision 4
print x              ' prints "44.1235"

precision 0
x = 2
a$ = x
f$ = "file" + a$ + ".dat"
print f$             ' prints "file2.dat"
```

**PURPOSE:**

To output data to the screen.

**SYNTAX:**

PRINT { *list of expressions* }

**EXPLANATION:**

The PRINT statement is used to output numeric and/or string expressions to the DesignCAD screen. It is identical to the PRINT # statement, except the data is output to the screen rather than to disk.

Only one line of output can be displayed at a time, unless a text window is open. If more than one line is to be output, the PRINT statements can be separated by ANYKEY statements. This requires the user to press a key before the next line is displayed.

If a text window is open (see the WINDOW statement), the PRINT statement will be displayed in the window. The LOCATE and TAB statements can be used to position the output for the window.

The PRINT statement can be terminated with a semicolon (";") to leave the cursor at the end of the line of a text window. The next PRINT statement will begin at that location.

The MESSAGE statement is similar to the PRINT statement, but the MESSAGE statement opens a dialog box for the message. The user must press the OK button to continue after the message is displayed.

**EXAMPLES:**

```
print j, " is the current value."
print "x: ", x, " Press any key to continue"
anykey
print "y: ", y
```

```
window 5, 20
print "abcd";
print "efgh"      ' "abcdefgh" will be printed
```

**PURPOSE:**

To output data to a disk file.

**SYNTAX:**

PRINT #*file*, { *list of expressions* }

**EXPLANATION:**

The PRINT # statement is used to output numeric and/or string expressions to a disk file. It is identical to the PRINT statement, except the data is output to disk rather than the screen. *File* is the file number that was used in the OPEN statement.

The file must have been opened using the OPEN statement before this statement is executed. Numeric expressions are output in ASCII format. A carriage-return and line-feed are output after each PRINT # statement.

The PRINT # statement can be used to output to a printer by opening the file "LPT1" with the OPEN statement. If no expressions are used with a PRINT # statement, a blank line is output.

**EXAMPLE:**

```
open "o", 1, "filename"
open "o", 2, "filetwo"
print #1, j, " is the current value."
print #2, "x = ", x
j = 2
print #j, x, y, z
print #1,
```

**PURPOSE:**

To output a record to a random access file

**SYNTAX:**

PUT *file*, *recordnumber*, *stringexpression*

**EXPLANATION:**

This statement is used to output a record to a random access file. The record length is specified in the OPEN statement.

When the PUT statement is executed, the string (*stringvar*) will be written to the file at the designated record (*recordnumber*).

If the string to be output is less than the record length, it will be padded with undefined characters. If the string is longer than the record length, it will be truncated.

The MKS\$ and the CVS functions can be used to convert numeric values to and from four-byte strings for file input and output.

**EXAMPLE:**

```
open "r", 1, "test.dat", 80
'   read a name and address into the first and
'   second 40 bytes of an 80 byte record then
'   output it to record number three.
input "Enter the name: ", name$
input "Enter the address: ", address$
i = 40 - len(name$)
a$ = name$ + string$(i, " "), address$
put 1, 3, a$           ' output to record three
next j
```

## PURPOSE:

To set the entity type, group status, and layer of an entity.

## SYNTAX:

PUTATTR *entity, type, {,select, layer, group, red, green, blue, solid}*

("Solid" represents the identifying number of the solid of which the entity is a part. If the entity is not part of a solid, then set *solid* to zero.)

## EXPLANATION:

This statement is used to set the entity type, status, layer, or group of an entity. *Entity* is the entity number – one for the first entity in the drawing, two for the second, etc. The specified entity will be assigned the specified attributes.

*Type* is the entity type, as shown:

- 1 = Line
- 2 = Ellipse
- 3 = Text
- 4 = Curve
- 5 = Elliptical Arc
- 11 = Bezier Curve
- 15 = Attribute
- 16 = Circle, Circular Arc
- 17 = Hatch
- 21 = New Layer
- 22 = Text Arc
- 23 = Layer Names
- 24 = Arrow
- 26 = Symbol
- 31 = Plane
- 32 = Grid
- 33 = Grid Line
- 70 = Point Mark
- 74 = Dimension, Angle
- 75 = Dimension
- 76 = Dimension, Diameter/Radius
- 77 = Dimension, Arc
- 78 = Dimension, Radius Progressive
- 79 = Dimension, Progressive
- 80 = Dimension, Chamfer
- 81 = Dimension, Coordinate
- 90 = Bitmap Image

*Select* is zero if the entity is not to be selected, and one if the entity is to be selected. *Layer* is the layer number to be assigned to the entity. *Group* is the group ID number if the entity is to

become part of that Group, or zero if it is not to be part of a Group. *Red*, *green*, and *blue* define the color for the entity.

**EXAMPLE:**

```
' Change all entities in layer 6 to layer 12.
l = 0
for j = 1 to sys(9) ' sys(9) is the number of entities
  getattr j, type, select, layr, group, red, green, blue
  if layr = 6 then layr = 12
  putattr j, type, select, layr, group, red, green, blue
next j
```

**PURPOSE:**

To resume program execution after an ON ERROR unit.

**SYNTAX:**

RESUME { *label* }

**EXPLANATION:**

The RESUME statement is used to continue program execution after an ON ERROR unit has been activated by a BasicCAD error.

*Label* can be used to specify the location at which program execution will resume. If the label is omitted, the program execution will resume at the statement following the statement that caused the error.

See the ON ERROR statement.

**EXAMPLE:**

```
on error goto handler
  open "i", 1, "-----"      ' invalid file name
  print "No error"           ' this won't be printed

cont:
  print "Program done"      ' second line printed
  end

handler:
  print "Error: ", err(1)   ' first line printed
  resume cont
```

**PURPOSE:**

To transfer control to another BasicCAD program or to a DOS or Windows program.

**SYNTAX:**

RUN *programname*\$

**EXPLANATION:**

The Run statement can be used to run another BasicCAD program or a COM or EXE program from within your BasicCAD program.

**Running another BasicCAD program with the RUN statement**

When this statement is used to run another BasicCAD program, all the variables from the current program are cleared when the other program is executed. A string variable or constant can be used for the program name.

The RUN statement causes the new program (*programname*) to replace the current program in memory. To return to the original program, you must execute another RUN or CHAIN statement from the new program. The execution of a program called by the RUN statement always begins at the first line in the called program.

If the file extension of the BasicCAD program is omitted, .BSC will be used. To use an encrypted BasicCAD program, specify the extension .BSX.

The CHAIN statement is similar to the RUN statement, but the CHAIN statement leaves all variables intact when the new program is executed.

**Running a BAT, COM, or EXE program with the RUN statement**

To run a program from within BasicCAD, just specify the program name with the RUN statement. For example,

```
run "edit.com c:\files\test.dat"
```

This command will run the DOS editor EDIT and automatically load the file TEST.DAT. The BasicCAD program will continue after EDIT.COM is closed.

With the RUN statement, you can run both DOS and Windows applications.

**EXAMPLE:**

```
run pgmname$  
  
run "test1"  
  
run "edit.com myfile.bsc"  
message "Finished Editing"
```



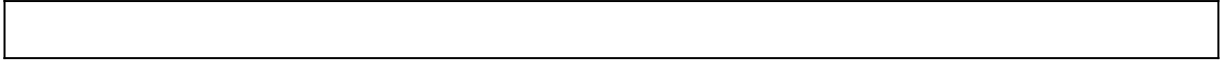

**PURPOSE:**

To require the user to set a number of points.

**SYNTAX:**

SETPOINT *string expression*

**EXPLANATION:**

This statement displays the message in "*string*," and allows the user to set a number of points. "*Expression*" is the number of points to be set. The user can press **Enter** or **Esc** before all the points are set. The system function SYS(1) is the current number of points set – it can be checked to determine if enough points were set.

**EXAMPLE:**

```
retry:
  setpoint "Set 2 to 4 points." 4
  if sys(1) < 2 then goto retry
```

**PURPOSE:**

To terminate the program and return to DesignCAD.

**SYNTAX:**

STOP

**EXPLANATION:**

The STOP statement can be placed anywhere in the program. A STOP statement at the end of the program is optional. This statement is the same as the END statement.

**EXAMPLE:**

```
if i > max then stop
```

**PURPOSE:**

To move the cursor in a text window to a certain column.

**SYNTAX:**

TAB *column*

**EXPLANATION:**

This statement moves the cursor to a specified column in the text window. The next PRINT statement will begin at that column.

If the new column is less than the current column, the cursor will move to the next line. The average character width of the current font is used to calculate character columns, since in Windows different characters may have different widths.

**EXAMPLE:**

```
window 5, 30      'open a window 5 x 30 chars.
print "left side"; ' ";" leaves on same line
tab 20            ' move to column 20
print "right side" ' print at column 20
```

**PURPOSE:**

To close the text window or dialog box.

**SYNTAX:**

WCLOSE

**EXPLANATION:**

This statement closes the text window, or dialog box. The drawing behind the text window will be replaced.

A text window that is opened by the WINDOW command remains on the screen until it is closed or until the program terminates.

**EXAMPLE:**

```
window 5, 20          ' open a window 5 x 20 chars.  
locate 3, 10  
print "This is a test"  
anykey  
wclose              ' close the text window
```

**PURPOSE:**

To open a text window or dialog box for subsequent PRINT statements.

**SYNTAX:**

WINDOW *nrows, ncols*

**EXPLANATION:**

This statement opens a text window or dialog box on the screen. *Nrows* and *ncols* are the number of rows and columns for the text window – they determine the window size.

As long as the text window is open, all PRINT statements are displayed in the window. The text window remains open until a WCLOSE statement is executed or until the program terminates.

The CLS, LOCATE, and TAB statements can be used to clear the screen and position the cursor in the text window. The COLOR statement can be used to set the text color inside the window.

Only one text window can be opened at a time.

**EXAMPLE:**

```
window 5, 20      ' open a window 5 x 20 chars.  
locate 3, 10  
print "This is a test"
```

BasicCAD functions can be used in numeric expressions. The functions all have a single numeric argument, which can be any numeric expression. For example, **ABS(J \* 2)** would be equal to the absolute value of **J \* 2**.

The following functions are supported:

### Numerical Functions

ABS(x)	Absolute Value.
ACOS(x)	Arc Cosine
ANGLE(dx, dy)	Get the angle between two points a distance of dx apart horizontally and dy vertically.
ASIN(x)	Arc Sine
ATAN(x)	Arc Tangent
COS(x)	Cosine
EXP(x)	Exponential - e <sup>X</sup>
INT(x)	Truncate to integer closest to zero.
LN(x)	Natural Logarithm
LOG(x)	Logarithm (base 10)
ODD(x)	Returns one if x is odd, zero if x is even.
ROUND(x)	Round to Closest Integer.
SGN(x)	Sign of x (-1 if negative, 1 if positive).
SIN(x)	Sine of x.
SQR(x)	Square.
SQRT(x)	Square Root
TAN(x)	Tangent.
TRUNC(x)	Truncate to integer closest to zero (same as INT).

### System Functions

AREA(i)	(where 'i' is the entity number of the object) This function works on both vector and surface entities ( planes and grids).
EOF(x)	Returns one if file x is at end-of-file, zero otherwise. Note that x is the number used to OPEN the file.
ERR(x)	Returns the error code of the error. This function returns zero until an ON ERROR has been activated. The error codes are listed in "BasicCAD Error Codes" in this Help file.
EXIST(a\$)	Returns one if file a\$ exists, zero if not, -1 if a\$ is an invalid file name.
LAYER(x)	Layer status of layer x. Returns 0-15 Assume y=LAYER(x) if ODD(y)=0,                   -> no entities in layer x. if ODD(y)=1,                   -> entities are in layer x. if ODD(y\2)=0,               -> layer x is invisible. if ODD(y\2)=1,               -> layer x is visible. if ODD(y\4)=0,               -> layer x is not editable. if ODD(y\4)=1,               -> layer x is editable. if ODD(y\8)=1,               -> x is the current layer.
LENGTH(i)	(where 'i' is the entity number of the object) This works on both vectors and planes.
SCREENX(z)	Returns screen X coordinate of drawing X coordinate z.
SCREENY(z)	Returns screen Y coordinate of drawing Y coordinate z.
VOLUME(k)	(where 'k' is the solid number) This ('k') must be obtained by selecting the object and then using sys(95) to determine its solid ID.

**Note:** See AREAVOL.BSC in the BASICCAD directory for a simple demonstration of these

---

functions.

---

## String Functions

ASC(a\$)	ASCII code for the first character of a\$.
CVS(a\$)	Convert the four-character string a\$ to a real number. This is the inverse of MKS\$.
INSTR(a\$, b\$)	Returns the location of the first occurrence of string b\$ in string a\$. Zero is returned if there are no occurrences.
LEN(a\$)	Length of string a\$.
VAL(a\$)	Numeric value of string a\$ (accepts feet-inches or degrees-minutes-seconds). For example:

A\$="2'4" returns 2.3333.

A\$="60D40M15S" returns 60.6708.

A\$="45" returns 45.000

CHR\$(x)	Returns the character with an ASCII code of x.
LEFT\$(a\$, x)	Returns the leftmost x characters of a\$.
MID\$(a\$, x, y)	Returns y characters of a\$ beginning at x.
MKS\$(x)	Converts x to a four-character string.
RIGHT\$(a\$, x)	Returns the rightmost x characters of a\$.
STRING\$(x, a\$)	Returns a string of x copies of a\$.

Two other functions are supported:

SYS(x)                      System Variable Function.

This function returns the value of a DesignCAD System Variable. The variable returned is determined by the value of the argument. See the SYS function.

SYS\$(x)                     System String Variable Function.

This function returns the value of a DesignCAD System StringVariable. The variable returned is determined by the value of the argument. See the SYS\$ function.

## SYS Functions

The SYS functions represent many different DesignCAD system variables. SYS(1), for example, is the number of points set, and SYS(3) is the current layer. A list of the available SYS variables and their valid ranges follows:

1	Number of points set [0-200]
3	Current layer [0-255]
7	Current precision [-7<=x<=7]
9	Number of entities in the drawing [read_only]
10	Units of measurement for display [1=inches, 0.0254=m, 2.54=cm, 25.4=mm.]
11	Units per inch on output [0<=x<=10e6]
12	Default text size [0<=x<=10e6]
13	Default text angle [-36<=x<=360]
14	Display grid type [1=XY, 2=YZ, 3=XZ]
15	Display grid enable/disable [1, 0]
17	Snap grid on or off [1, 0]
19	Display grid size [0<=x<=10e6]
20	Snap grid size [0<=x<=10e6]
21	Attribute display enable/disable [1, 0]
22	Save parameters with drawing, enable/disable [1, 0]
23	Mathematical or geographical angles [1, 0]



25 Sound off/on/error only [0, 1, 2]  
 26 Manipulate current layer only off/on [0, 1]  
 30 Large cursor step size [ $0 \leq x \leq 10e6$ ]  
 31 Small cursor step size [ $0 \leq x \leq 10e6$ ]  
 32 Drawing unit size [ $0 \leq x \leq 10e6$ ]  
 34 Returns 1 if entities are selected, 0 otherwise  
 35 Number of sides in the rubber-band polygon [3-100]  
 37 Cursor step consistent with Screen or Drawing [1, 2]  
 38 Mirror Text enable/disable [1, 0]  
 40 Crosshair enable/disable [1, 0]  
 80 Number of entities currently selected [read\_only]  
 Not affected by PUTATTR

Functions 90-99 are values for an entity just selected with the Entity statement. They are all read\_only values.

90 Entity type  
 91 Entity line type  
 92 Obsolete -- See Sys\$(92) for entity color information  
 93 Entity layer  
 94 Group Number  
 95 Solid Number  
 96 Entity selected? [1=yes, 2=no]  
 99 Number of points in entity (or number of grid lines for grid entity)  
 101 Dimension type [1, 2, 3, 4]  
 104 Arrowhead type [1, 2, 3, 4]  
 106 Dimension precision [ $-7 \leq x \leq 7$ ]  
 110 Coordinate system [-1 = left-hand, 1 = right-hand]  
 120 Minimum X value in the drawing [read\_only]  
 121 Minimum Y value in the drawing [read\_only]  
 122 Maximum X value in the drawing [read\_only]  
 123 Maximum Y value in the drawing [read\_only]  
 124 Minimum Z value in the drawing [read\_only]  
 125 Maximum Z value in the drawing [read\_only]  
 134 Printer top margin [varies with media]  
 135 Printer bottom margin [varies with media]  
 136 Printer left margin [varies with media]  
 137 Printer right margin [varies with media]  
 152 Scale drawings on retrieval and copy option 1=fixed, 2=changeable  
 190 Handle 1 X value [ $-10e6 \leq x \leq 10e6$ ]  
 191 Handle 1 Y value [ $-10e6 \leq x \leq 10e6$ ]  
 192 Handle 2 X value [ $-10e6 \leq x \leq 10e6$ ]  
 193 Handle 2 Y value [ $-10e6 \leq x \leq 10e6$ ]  
 194 Handle 3 X value [ $-10e6 \leq x \leq 10e6$ ]  
 195 Handle 3 Y value [ $-10e6 \leq x \leq 10e6$ ]  
 202 Handle 1 Z value [ $-10e6 \leq x \leq 10e6$ ]  
 203 Handle 2 Z value [ $-10e6 \leq x \leq 10e6$ ]  
 204 Handle 3 Z value [ $-10e6 \leq x \leq 10e6$ ]  
 205 View Angle about X axis  
 206 View Angle about Y axis  
 207 View Angle about Z axis  
 208 View Distance  
 209 Projection Mode [0=perspective, 1=parallel]  
 300 Current drawing color, Red value [0-255]

```

301 Current drawing color, Green value [0-255]
302 Current drawing color, Blue value [0-255]
306 Rubber-band color, Red value [0-255]
307 Rubber-band color, Green value [0-255]
308 Rubber-band color, Blue value [0-255]
309 Display grid color, Red value [0-255]
310 Display grid color, Green value [0-255]
311 Display grid color, Blue value [0-255]
312 Point color, Red value [0-255]
313 Point color, Green value [0-255]
314 Point color, Blue value 0-255]
315 Selection color, Red value [0-255]
316 Selection color, Green value [0-255]
317 Selection color, Blue value [0-255]
321 Background color, Red value..[0-255]
322 Background color, Green value..[0-255]
323 Background color, Blue value..[0-255]
327 Entity point color (when in Point Selection Mode), Red value [0-255]
328 Entity point color, Green value [0-255]
329 Entity point color, Blue value [0-255]
331 Cursor color, Red value
332 Cursor color, Green value
333 Cursor color, Blue value
334 3D cursor X color, Red value
335 3D cursor X color, Green value
336 3D cursor X color, Blue value
337 3D cursor Y color, Red value
338 3D cursor Y color, Green value
339 3D cursor Y color, Blue value
340 3D cursor Z color, Red value
341 3D cursor Z color, Green value
342 3D cursor Z color, Blue value
343 Smooth Solids On/Off [1, 0]
413 Dimension layer [0-255]
433 Angular dimension precision [-7<=x<=7]
438 Dimension text size [0<=x<=10e6]
442 overshoot of Dimension extension lines [0<=x<=10e6]
443 gap of Dimension extension lines [0<=x<=10e6]
445 arrow size [0<=x<=10e6]
460 dimension arrowhead type [1-4]
462 dimension arrowhead scale [0<=x<=1.0e6]
999 INPUT Exit condition: 0 for Enter or OK; 1 for Esc or Cancel
[read_only]

```

To use the SYS function in a BasicCAD program, use it like you would any other function. For example, the following program segment checks to make sure at least three points have been set:

```

if sys(1) < 3 then
  setpoint "Set at least three points." 3
end if

```

The SYS function is different from the other BasicCAD functions in that you can assign a value to most SYS variables. In other words, you can use the SYS function on the left side of the equal sign in an Assignment statement. For example, to set the current layer to layer number seven, you could use the following statement:

```
SYS (3) = 7
```

This is equivalent to using the BasicCAD statement `LAYER (7) =14`.

SYS variables nine (the number of entities in the drawing) and 90-99 (entity characteristics) cannot be modified by assigning a value to the SYS function they are read-only variables. There are other read-only SYS variables; they are noted as such in the chart above.

When some of the SYS variables are modified, the DesignCAD drawing screen should be regenerated with the DesignCAD Regen command or the DesignCAD Zoom command. For example, if you change the view characteristics (SYS variables 71-79) or the screen colors (SYS variables 50-59), the drawing screen must be regenerated for correct operation. BasicCAD does NOT check for valid SYS assignments or screen regeneration. If you change the SYS variables, your BasicCAD program is responsible for all validity checking.

The SYS variables 90-93 can be used together with the BasicCAD ENTITY statement to read the type, line type, and layer of the entity referred to by the last ENTITY statement.

### **SYS\$ Function**

The SYS\$ function represents several different DesignCAD system variables in string format. SYS\$(6), for example, is the current path name. A list of the available SYS\$ functions follows:

- 1 Entity text string. This is the text from a Text or Attribute entity that was "loaded" with the ENTITY statement
- 2 Current drawing name
- 6 Current path name
- 20 DesignCAD drawing path name
- 21 DesignCAD symbol path name
- 22 DesignCAD bitmap path name
- 23 DesignCAD macro path name
- 24 DesignCAD BasicCAD path name
- 25 DesignCAD view path name
- 26 DesignCAD color path name
- 27 DesignCAD DXF path name
- 28 DesignCAD IGES path name
- 29 DesignCAD HPGL path name
- 30 DesignCAD XY file path name
- 31 DesignCAD ASCII text path name
- 34 DesignCAD material list file LST path name
- 40 Windows clipboard text string I/O
- 92 Entity color. This 9-digit string represents the RGB values for the color of the item referenced by the last ENTITY statement. It replaces sys(92) in earlier versions of DesignCAD. The first three characters represent the red component, the second three represent the green component, and the last three the blue component of the color.

To use the SYS\$ function in a BasicCAD program, use it like you would any other string function. For example, the following program displays the current drive and path name:

```
message sys$(6)
```

If you write a BasicCAD program for distribution, it is possible that you do not want to distribute the source code for your program. Since BasicCAD programs are interpreted and do not have a separate executable format, the ENCRYPT utility has been provided to allow you to distribute your programs without distributing the source code.

BasicCAD programs have a file extension of .BSC, and encrypted BasicCAD programs have a file extension of .BSX. Either form can be read and executed by DesignCAD. To encrypt a program, click on the **ENCRYPT** icon in your DesignCAD program group. An encrypted copy of your program will be created with an extension of .BSX. The encrypted version can be executed, but since it is encrypted it cannot be listed, printed, or edited.

Encrypting a BasicCAD program makes no noticeable degradation in performance.

The ENCRYPT program only encrypts programs. It does NOT decrypt, or "un-encrypt."

**Note:** BE SURE TO KEEP A COPY OF YOUR SOURCE CODE.

---

Also, remember that NO ENCRYPTION METHOD IS UNBREAKABLE, and this one is no exception. ViaGrafix Corporation makes no guarantee as to the security of the encryption methods used by the ENCRYPT program.

**Maximum Program Size:** Depends on available memory up to 5000 lines. Blank lines and lines containing only comments do not count.

**Maximum Array Size:** Depends on available memory up to 32000 elements.

**Maximum Number of Array Dimensions:** 1

**Maximum Number of Symbols:** 300. An array is one symbol. Symbols include Labels and Variables.

**Maximum String Size:** 255 characters.

**Maximum Nesting for Group IF:** 8.

**Maximum Nesting for FOR-NEXT:** 8.

**Maximum Nesting for DO-LOOP:** 8.

**Maximum Nesting for GOSUB:** 8.

When the BasicCAD Interpreter encounters an error, the error code is displayed along with the BasicCAD line that the error occurred in. The BasicCAD error codes and their meanings are listed below:

- 1 Out of memory. There are too many numeric variables.
- 2 Invalid numeric expression.
- 3 "[" does not have a matching "]".
- 5 There is an unmatched " in a string constant.
- 6 There is an ELSE without a corresponding IF statement.
- 7 There is an ENDIF without a corresponding IF statement.
- 8 An invalid variable name was encountered.
- 11 A FOR statement is nested too deeply.
- 13 A FOR statement has invalid syntax.
- 15 An IF statement has invalid syntax.
- 16 A Group IF statement does not have a corresponding END IF statement.
- 21 Invalid syntax in OPEN statement.
- 22 Invalid file name.
- 23 CLOSE statement was encountered when the file was not open.
- 26 The subscript is out of range in a numeric array. Be sure the value of the subscript is within the range set in the DIM statement.
- 28 The external subroutine file could not be loaded. Be sure the file name is correct, and that there is enough memory for the subroutine.
- 31 A DO statement is nested too deeply.
- 32 Invalid syntax in DO statement.
- 33 No LOOP statement was found for the DO statement.
- 34 The EXIT statement is not inside a loop.
- 35 A FOR or DO statement does not have a corresponding LOOP or NEXT statement.
- 36 Out of string space.
- 37 Out of symbol space.
- 38 Invalid syntax.
- 39 An array has been re-dimensioned, or the dimension statement occurs after the first use of the variable.
- 40 There is a FOR statement without a corresponding NEXT statement.
- 41 A String is too long—more than 80 characters.
- 42 An error occurred reading a disk file.
- 43 A disk file read was attempted after end-of-file was reached.
- 44 A disk file read was attempted when the file was not open for input.
- 45 A disk file write was attempted when the file was not open for output.
- 46 A disk file could not be opened.
- 47 The expression in a POINTVAL statement is larger than the number of points currently set.

- 48 Not enough memory is available to run a program.
- 49 Not enough memory is available to read the program.
- 50 The label in a GOTO or GOSUB statement was not found.
- 51 A GOSUB statement is nested too deeply.
- 52 A RETURN statement was encountered without a GOSUB.
- 53 Too many symbols are in the program.
- 54 There is a duplicate label in program.
- 55 A label name is too long. It must be a maximum of seven characters plus a colon.
- 56 The program file could not be opened.
- 57 The subscript was out of range in a LAYER statement.
- 58 A division by zero was attempted.
- 59  $X ^ Y$  was encountered where  $X < 0$ . X must be positive.
- 60 The entity number was out of range in an ENTITY, GETATTR, or PUTATTR statement.
- 61 Syntax error in GET or PUT statement.
- 62 File I/O error in GET or PUT statement.
- 63 Invalid record length in OPEN statement.
- 64 Invalid record number in GET or PUT statement.
- 65 The file number in an OPEN statement was already open.
- 66 Error in CALLEXT statement.
- 67 Invalid precision in PRECISION statement.
- 68 A window was already open when a WINDOW statement was executed.
- 69 Too many string variables are in the program.
- 92 Sys(92) is no longer supported. You should use Sys\$(92) to get the entity's color.
- 100 An error occurred in a DesignCAD command.
- 102 An expression is invalid. This is caused by a syntax error.
- 103 An expression or statement is too complex. If possible, divide it into two less complex expressions.
- 104 An invalid argument was used with a numeric function.
- 105 Too many files are open for a CHAIN or RUN statement. A maximum of three files can be open.
- 106 A GET or a PUT statement was attempted when the file was not open or was not opened for random access ("R").
- 107 The layer number in a LAYER statement was out of range.



The following key words cannot be used as BasicCAD variables.

ABS	FPRINT	OPEN
ACOS	GET	POINTVAL
ANYKEY	GETATTR	PRECISION
AREA	GETSELECT	PRINT
ASC	GETXY	PUT
ASIN	GOSUB	PUTATTR
ATAN	GOTO	RESUME
CALLEXT	HCOS	RETURN
CHAIN	HSIN	RIGHT\$
CHR\$	HTAN	ROUND
CLEAR	IF	TRUNC
CLOSE	INPUT	SCREENX
CLS	INSTR	SCREENY
COLOR	INT	SETPOINT
COS	LABEL	SGN
CVS	LAYER	SIN
DIM	LEFT\$	SQR
DO	LEN	SQRT
ELSE	LENGTH	STOP
END	LN	STR
ENDIF	LOADEXT	STRING\$
ENTITY	LOCATE	SYS
EOF	LOG	SYS\$
ERR	LOOP	TAB
EXIST	MID\$	TAN
EXIT	MKS\$	TRUNC
EXP	NEXT	WCLOSE
FINPUT	ODD	WINDOW
FOR	ON	

DesignCAD 97 macro commands can be used in BasicCAD by preceding the command name with a ">." You must enclose the parameters in braces ({} ) and begin each parameter with "<."

**Note:** Even if a command requires no parameters, you must follow the command with the braces.

---

For example, use the following code fragment to draw a line through specific points, then have the user set all the points for a curve:

```
>Line
{
<color [R, G, B]
<pointxyz [X],10,0
```

```

<pointxyz [X, Y, Z]
<pointxyz 10,[Y, Z]
}
>Curve
{
}

```

For more comprehensive examples of macro command and parameter usage, examine the sample BasicCAD programs provided on the installation disks.

## Commands

The following table shows the available macro commands. The majority of these commands accept the <color, <layer, and <linestyle parameters (See the "DesignCAD 97 Parameters" section for details on these parameters).

### Macro Command

#### 2DBox

```

{
  <Orientation o
    0 = normal, 1 = align to any angle
  <Type t
    0 = plane, 1 = vector
}
Parameters for Ole Automation:
  createAs: 0=line, 1 = plane
  alignment: 0=XY (two points), 1=any angle (3 points)

```

#### 2DMode

```

{
}

```

#### 2DSelectMode

```

{
}

```

#### 3DSelectMode

```

{
}

```

#### AboutDesignCAD

```

{
}

```

#### Acquire

```

{
}

```

#### AngleDistance

```

{
}

```

#### Arc=ID\_ARC

```

{
  <Type t

```

```
    [0 = arc, 1 = line]
    <Angle a
        span angle of the arc
    }
```

Parameters for Ole Automation:  
createAs: 0=arc, 1 = vector arc  
angle: span angle of the arc

## Arc2

```
{
    <Type t
        [0 = arc, 1 = line]
    <Radius r
        radius of the arc
    }
```

Parameters for Ole Automation:  
createAs: 0=arc, 1 = vector arc  
radius: radius of the arc

## Arc3

```
{
    <Type t
        [0 = arc, 1 = line]
    }
```

Parameters for Ole Automation:  
createAs: 0=arc, 1 = vector arc

## Arc4

```
{
    <Type t
        [0 = arc, 1 = line]
    }
```

Parameters for Ole Automation:  
createAs: 0=arc, 1 = vector arc

## Arc5

```
{
    <Type t
        0 = arc, 1 = line
    }
```

Parameters for Ole Automation:  
createAs: 0=arc, 1=vector arc

## Arc6

```
{
    <type t [0=arc 1=line]
    <radius r
    <length l
    }
```

Parameters for Ole Automation:  
createAs: 0=arc, 1=vector arc  
radius: radius of the arc  
length: desired arc length

## Area

```
{
}
```

## Arrangelcons

```
{  
}
```

## Array

```
{  
  <NCopy n1, n2, n3  
    n1 = number of duplicates along first direction  
    n2 = number of duplicates along second direction  
    n3 = number of duplicates along 3rd direction  
}
```

Parameters for Ole Automation:

```
nRepCopy1: number of duplicates along 1st direction  
nRepCopy2: number of duplicates along 2nd direction  
nRepCopy3: number of duplicates along 3rd direction
```

## Arrow

```
{  
  <type t [1=normal,2=slash,3=filled circle,4=filled normal,5=filled  
  long,6=none,7=circle,8=hollow normal,9=hollow long,10=wide,11=filled wide,12=hollow wide]  
  <size s  
    arrowhead size  
}
```

Parameters for Ole Automation:

```
arrowSize: size of the arrowhead  
arrowType: arrowhead shape
```

## Attribute

```
{  
  <style t  
    0 = normal, 1 = bold, 2 = italic, 3 = bold italic  
  <justification  
    0 = left, 1 = center, 2 = right  
  <size s  
    text size  
  <font font$  
    the full name of the Windows font, ex. "Times New Roman"  
  <text text$  
    the text contents of the attribute  
}
```

Parameters for Ole Automation:

```
textContent: the text to be drawn  
textSize: the height of the text  
textStyle: 0=normal, 1=bold, 2=italic, 3=bold italic  
textJust: 0=left-justified, 1=centered, 2=right-justified  
font: font name, ex. "Times New Roman"
```

## Balloon

```
{  
  <Font font$  
    Font name  
  <Text content$  
    text to place in the balloon  
  <Size 2.0000  
    Balloon radius  
  <Arrowhead i  
    Arrowhead style [1-12]; if not set, uses Sys(652)
```

```
<Arrowsize as
  Size of Arrowhead
}
```

Parameters for Ole Automation:

```
font: text font
arrowSize: size of arrowhead relative to text size
arrowType: type of arrowhead
textContent: text to appear in the balloon
balloonSize: radius of the balloon
```

## BezierCurve

```
{
  <Incomplete - If this parameter is present, it allows the user to set more points.
}
```

Parameters for Ole Automation

```
incomplete: True allows the user to set more points; False completes immediately
```

## Box

```
{
}
```

## BreakLine

```
{
}
```

## Calculator

```
{
}
```

## CascadeWindows

```
{
}
```

## CenterOfGravity

```
{
  <pointxyz x, y, z
}
```

## Chamfer

```
{
  <depth d
    chamfer depth
  <Type t
    [0 = normal fillet, 1 = keep original lines]
}
```

Parameters for Ole Automation:

```
depth: chamfer depth
originalLines: True keeps original "tails", False trims them away
```

## Circle

```
{
  <type t
    0 = circle, 1 = vector circle, 2 = plane
}
```

Parameters for Ole Automation:

```
createAs: 0=circle, 1=vector circle, 2=plane
```

## Circle2

```

{
  <type t
    0 = circle, 1 = vector circle, 2 = plane
  }
Parameters for Ole Automation:
  createAs: 0=circle, 1=vector circle, 2=plane

```

### Circle3

```

{
  <type t
    0 = circle, 1 = vector circle, 2 = plane
  }
Parameters for Ole Automation:
  createAs: 0=circle, 1=vector circle, 2=plane

```

### Circle4

```

{
  <type t
    0 = circle, 1 = vector circle, 2 = plane
  <radius r
    radius of the circle
  }
Parameters for Ole Automation:
  createAs: 0=circle, 1=vector circle, 2=plane
  radius: radius of the circle

```

### CircleTan2Lines

```

{
  <type t
    0 = circle, 1 = vector circle, 2 = plane
  <radius r
    radius of the circle
  }
Parameters for Ole Automation:
  createAs: 0=normal circle, 1 = vector circle, 2 = plane
  radius: desired radius of the circle

```

### CircleTan3Lines

```

{
  <type t
    0 = circle, 1 = vector circle, 2 = plane
  }
Parameters for Ole Automation:
  createAs: 0=normal circle, 1 = vector circle, 2 = plane

```

### CircularArray

```

{
  <angle a
    span angle for the array of copies
  <axis j
    central axis for the array: 0 = x, 1 = y, 2 = z, 3 = 2-point, 4 = line, 5 = plane
  <ncopy m
    number of copies to create (including original)
  <offset d
    total offset from first to last copy along central axis
  }
Parameters for Ole Automation:
  nCopy: number of duplicates in the array (including the original)

```

angle: sweep angle of the array  
offset: distance between original and last copy, measured along the central axis  
axis: the central line about which the objects are copied.  
0=x, 1=y, 2=z, 3=2-point custom axis, 4= existing line

## ClearDrawingHandle

```
{  
}
```

## Close

```
{  
  <SaveChanges s [0 = no, 1 = yes]  
  <FileName "Filename"  
    If a specific filename is given in quotes, the file will be saved with that name. An empty  
    string "" saves the file under its current name. A question mark in quotes "?" will close  
    the file if no changes have been made, or open the "Save Changes?" dialog box if the  
    drawing has changed.  
}
```

Parameters for Ole Automation:

saveChanges: True to save, False to close without saving

Filename: "" to use the current name, "?" to let the program decide, or "newfilename.dc" to  
save as newfilename. If you use "?" for the filename, the program will prompt the user if the  
drawing has changed since its last save, or will simply close it if there have been no  
changes.

## ColorToolBox

```
{  
}
```

## Combine

```
{  
}
```

## Cone

```
{  
  <nface m  
    number of sides for the cone [3-100]  
  <orientation o  
    0: point 2 is a vertex, 1: point 2 is the midpoint of a side  
}
```

Parameters for Ole Automation:

orientation: determines the position of point 2; 0 = vertex, 1 = midpoint

nfacet: the number of sides for the cone

## CoordinateBar

```
{  
}
```

## Copy

```
{  
}
```

## CopyBitmap

```
{  
}
```

## Crosshair

```
{  
}
```

## CursorOptions

```
{  
}
```

## Curve

```
{  
  <incomplete  
    If this parameter is included, the command will wait for the user to either (a) set enough  
    points to complete the command or (b) end the command by pressing "Enter"  
  <type n  
    0 = spline curve, 1 = vectorized curve  
}
```

Parameters for Ole Automation:

createAs: 0 = curve, 1 = vector curve

incomplete: True=user can keep setting points; False=use only points already set.

## CurveToLine

```
{  
}
```

## CustomColor

```
{  
  <color r, g, b  
}
```

## Cut

```
{  
}
```

## Cutoff

```
{  
}
```

## CutoffDel

```
{  
}
```

## CutPlane

```
{  
}
```

## Cylinder

```
{  
  <nface m  
    number of faces [3-100]  
  <orientation o  
    0 = point 2 on vertex, 1 = point 2 on midpoint of a side  
}
```

Parameters for Ole Automation:

orientation: location of point 2 on base polygon; 0 = vertex, 1=midpoint

nFacet = number of sides for the cylinder

## DCADTile

```
{  
}
```

## DecVDis

```
{
```



```
}
```

## DimAngle

```
{  
  <type t  
    [0 = single dimension entity, 1 = exploded dimension]  
  <font "fontname"  
  <arrowhead a  
    arrowhead shape - see arrow command for details  
  <arrowsize as  
    arrowhead size  
  <size s  
    dimension text size - if 0.0, uses default text size  
  <gap g  
    distance between measured points and bottom of leader lines  
  <length l  
    length of fixed-length leader lines  
  <fix fx  
    [0 for variable-length leader lines, 1 for fixed-length  
  <overshoot d  
    distance from arrow tips to tops of leader lines  
  <orientation o  
    text orientation [0 = tangent to arc, 1 = horizontal]  
  <precision p  
    number of digits after the decimal point  
  <Format f  
    angular text format [0=degrees, 1 = grads, 2 = radians, 3 = DMS]  
  <location k  
    location of text [0 = outside arrows, 1 = inside arrows]  
  <ToleranceType tt  
    [0 = none, 1 = single value, 2 = high/low values]  
  <ToleranceSize ts  
    relative size of tolerance text (only affects tolerance type 2)  
  <ToleranceLow tl  
    low tolerance value for tolerance type 2  
  <ToleranceHigh th  
    high tolerance value for tolerance type 2  
  <Tolerance tol  
    tolerance value for tolerance type 1  
  <Prefix i$  
    dimension prefix ["0" = none, "1" = custom1, "2" = custom2, etc.]  
  <Suffix j$  
    dimension suffix ["0" = none, "1" = custom1, etc.]  
}
```

Parameters for Ole Automation:

```
font: font for the dimension  
textSize: the size of the dimension text  
arrowSize: the size of the arrowheads  
arrowType: the arrowhead style [1-12]  
orientation: orientation of the text relative to the arrows;  
  0=aligned with arc, 1 = horizontal, 2 = reversed, aligned, 3=reversed, horizontal  
precision: number of places past the decimal (fractional power of 2 for fractions)  
dimFormat: 0=decimal degrees, 1=grads, 2=radians, 3=degrees-minutes-seconds  
textLocation: placement of text; 0=outside arc, 1=inside arc  
gapsize: distance between measured point and bottom of leader line (scaled by textsize)  
fixedLength: True = fixed leader length, False = variable leader length  
  note: fixedLength=True and gapsize cannot be used at the same time;
```

length: length of leader line (only relevant if fix = True) (scaled by textsize)  
overSize: distance leader line extends past arrowtip (scaled by textsize)  
createAs: 0 = normal dimension, 1 = exploded dimension(grouped)  
toleranceType: 0=none, 1 = single-value, 2 = upper and lower value  
tolerance: tolerance value for toleranceType=1  
toleranceUpper: Upper tolerance value for toleranceType=2 (include the sign)  
toleranceLower: Lower tolerance value for toleranceType=2 (include the sign)  
toleranceTextSize: relative size of the tolerance text for toleranceType=2  
prefixIndex: dimension prefix; [0-5; 0=none]  
suffixIndex: dimension suffix; [0-5; 0=none]

## DimArc=ID\_DIMARC

```

{
  <Orientation o
    Text orientation [0 = tangent to arc, 1 = horizontal]
  <Precision p
    Number of digits past the decimal in the dimension text
  <Format f
    Text format [0 = 4.125, 1 = 4-1/8, 2 = 4'1.5", 3 = 4'1-1/2"]
  <Location l
    Text location relative to arrows [0 = inside, 1 = outside]
  <ToleranceType tt
    [0 = none, 1 = single value, 2 = high/low values]
  <ToleranceSize ts
    relative size of tolerance text for tolerance type 2
  <ToleranceLow tl
    low tolerance value for tolerance type 2
  <ToleranceHigh th
    high tolerance value for tolerance type 2
  <Tolerance tv
    tolerance value for tolerance type 1
  <Suffix i$
    dimension suffix ["0" = none, "1" = custom1, "2" = custom2, etc.]
  <Prefix "j$
    dimension prefix ["0" = none, "1" = custom1, "2" = custom2, etc.]
  <Font "fontname"
  <Size s
    dimension text size; if 0.0, uses the default text size.
  <Type t
    [0 = dimension, 1 = exploded dimension]
  <Gap g
    distance between measured points and leader bottoms
  <length l
    length of fixed-length leader lines
  <fix fx
    [0 for variable-length leader lines, 1 for fixed-length]
  <OverShoot os
    distance between arrow tips and leader tops
  <Arrowhead a
    arrowhead style; see arrow command for details
  <Arrowsize as
    arrowhead size
}

```

Parameters for Ole Automation:

font: font for the dimension  
textSize: the size of the dimension text  
arrowSize: the size of the arrowheads (scaled by textsize)

arrowType: the arrowhead style [1-12]  
 orientation: orientation of the text relative to the arrows; 0=aligned with arc, 1 = horizontal, 2 = reversed, aligned, 3=reversed, horizontal  
 precision: number of places past the decimal (fractional power of 2 for fractions)  
 dimFormat: 0=decimal degrees, 1=grads, 2=radians, 3=degrees-minutes-seconds  
 textLocation: placement of text; 0=outside arc, 1=inside arc  
 gapsize: distance between measured point and bottom of leader line (scaled by textsize)  
 fixedLength: True = fixed leader length, False = variable leader length  
     note: fixedLength=True and gapsize cannot be used at the same time;  
 length: length of leader line (only relevant if fix = True) (scaled by textsize)  
 overSize: distance leader line extends past arrowtip (scaled by textsize)  
 createAs: 0 = normal dimension, 1 = exploded dimension(grouped)  
 toleranceType: 0=none, 1 = single-value, 2 = upper and lower value  
 tolerance: tolerance value for toleranceType=1  
 toleranceUpper: Upper tolerance value for toleranceType=2 (include the sign)  
 toleranceLower: Lower tolerance value for toleranceType=2 (include the sign)  
 toleranceTextSize: relative size of the tolerance text for toleranceType=2 (scaled by textsize)  
 prefixIndex: dimension prefix; [0-5; 0=none]  
 suffixIndex: dimension suffix; [0-5; 0=none]

## DimBase=ID\_DIMBASE

```

{
  <Orientation o
    Text orientation [0 = aligned with arrows, 1 = perpendicular,
      2 = horizontal, 3 = vertical]
  <Precision p
    Number of digits past the decimal in the dimension text
  <Format f
    Text format [0 = 4.125, 1 = 4-1/8, 2 = 4'1.5", 3 = 4'1-1/2"]
  <Location l
    Text location relative to arrows [0 = inside, 1 = outside]
  <ToleranceType tt
    [0 = none, 1 = single value, 2 = high/low values]
  <ToleranceSize ts
    relative size of tolerance text
  <ToleranceLow tl
    low tolerance value for tolerance type 2
  <ToleranceHigh th
    high tolerance value for tolerance type 2
  <Tolerance tv
    tolerance value for tolerance type 1
  <Suffix i$
    dimension suffix ["0" = none, "1" = custom1, "2" = custom2, etc.]
  <Prefix "j$
    dimension prefix ["0" = none, "1" = custom1, "2" = custom2, etc.]
  <Font "fontname"
  <Size s
    dimension text size
  <Type t
    [0 = dimension, 1 = exploded dimension]
  <Gap g
    distance between measured points and leader bottoms
  <length l
    length of fixed-length leader lines
  <fix fx
    [0 for variable-length leader lines, 1 for fixed-length
  <OverShoot os

```

```

    distance between arrow tips and leader tops
<Arrowhead a
    arrowhead style; see arrow command for details
<Arrowsize as
    arrowhead size
<LinePosition lp
    [0 = arrows inside leaders, 1 = arrows outside leaders]
<Axis y
    [1 = horizontal, 2 = vertical]
}
font: font for the dimension
textSize: the size of the dimension text
arrowSize: the size of the arrowheads
arrowType: the arrowhead style [1-12]
orientation: orientation of the text relative to the arrows;
    0=aligned with arrows, 1 = perpendicular to arrows, 2 = horizontal, 3=vertical, 4-
    7=reversed versions of 0-3
precision: number of places past the decimal (fractional power of 2 for fractions)
dimFormat: text format;
    0=decimal, 1=fractional, 2=feet-inches(decimal), 3=feet-inches(fractional inches)
textLocation: placement of text;
    0=between arrows, 1=above, 2=below, 3=left, 4=upper left, 5=lower left, 6=right, 7=upper
    right, 8 = lower right
gapsize: distance between measured point and bottom of leader line (relative to text size;
gapsize=2.5 and textsize=2 gives a net gap of 5)
fixedLength: True = fixed leader length, False = variable leader length
    note: fixedLength=True and gapsize cannot be used at the same time;
length: length of leader line (scaled to text size; only used if fixedLength=True)
overSize: distance leader line extends past arrowtip (scaled by textsize)
offset: separation between successive sets of arrows. (scaled by textsize)
createAs: 0 = normal dimension, 1 = exploded dimension(grouped)
axis: direction of measurement; 0=horizontal, 1=vertical
toleranceType: 0=none, 1 = single-value, 2 = upper and lower value
tolerance: tolerance value for toleranceType=1
toleranceUpper: Upper tolerance value for toleranceType=2 (include the sign)
toleranceLower: Lower tolerance value for toleranceType=2 (include the sign)
toleranceTextSize: size of the tolerance text for Type 2 (scaled by textsize)
prefixIndex: dimension prefix; [0-5; 0=none]
suffixIndex: dimension suffix; [0-5; 0=none]

```

## DimChamfer

```

{
<Orientation o
    Text orientation [0 = aligned with arrows, 1 = perpendicular,
    2 = horizontal, 3 = vertical]
<Precision p
    Number of digits past the decimal in the dimension text
<Format f
    Text format [0 = 4.125, 1 = 4-1/8, 2 = 4'1.5", 3 = 4'1-1/2"]
<Location l
    Text location relative to arrows [0 = inside, 1 = outside]
<ToleranceType tt
    [0 = none, 1 = single value, 2 = high/low values]
<ToleranceSize ts
    relative size of tolerance text
<ToleranceLow tl
    low tolerance value for tolerance type 2
<ToleranceHigh th

```

```

    high tolerance value for tolerance type 2
<Tolerance tv
    tolerance value for tolerance type 1
<Suffix i$
    dimension suffix ["0" = none, "1" = custom1, "2" = custom2, etc.]
<Prefix "j$
    dimension prefix ["0" = none, "1" = custom1, "2" = custom2, etc.]
<Font "fontname"
<Size s
    dimension text size
<Type t
    [0 = dimension, 1 = exploded dimension]
<Gap g
    distance between measured points and leader bottoms
<length l
    length of fixed-length leader lines
<fix fx
    [0 for variable-length leader lines, 1 for fixed-length
<OverShoot os
    distance between arrow tips and leader tops
<Arrowhead a
    arrowhead style; see arrow command for details
<Arrowsize as
<LinePosition lp
    [0 = arrows inside leaders, 1 = arrows outside leaders]
<Axis y
    [1 = horizontal, 2 = vertical]
}

```

Parameters for Ole Automation:

```

font: font for the dimension
textSize: the size of the dimension text
arrowSize: the size of the arrowheads
arrowType: the arrowhead style [1-12]
orientation: orientation of text relative to arrow
    0=aligned with arrow, 1 = perpendicular to arrow, 2 = horizontal, 3=vertical, 4-7=reversed
    versions of 0-3
precision: number of places past the decimal (fractional power of 2 for fractions)
dimFormat: text format;
    0=decimal, 1=fractional, 2=feet-inches(decimal), 3=feet-inches(fractional inches)
textLocation: placement of text;
    0=aligned with arrow, 1=above arrow, 2=below arrow
createAs: 0 = normal dimension, 1 = exploded dimension(grouped)
toleranceType: 0=none, 1 = single-value, 2 = upper and lower value
tolerance: tolerance value for toleranceType=1
toleranceUpper: Upper tolerance value for toleranceType=2 (include the sign)
toleranceLower: Lower tolerance value for toleranceType=2 (include the sign)
toleranceTextSize: size of the tolerance text for toleranceType=2 (scaled by textsize)
prefixIndex: dimension prefix; [0-5; 0=none]
suffixIndex: dimension suffix; [0-5; 0=none]Default=1 ("x45°")

```

## DimCoordinate

```

{
<Orientation o
    Text orientation [0 = aligned with arrows, 1 = perpendicular, 2 = horizontal, 3 =
    vertical]
<Precision p
    Number of digits past the decimal in the dimension text
<Format f

```

```

    Text format [0 = 4.125, 1 = 4-1/8, 2 = 4'1.5", 3 = 4'1-1/2"]
<Location l
    Text location relative to arrows [0 = inside, 1 = outside]
<ToleranceType tt
    [0 = none, 1 = single value, 2 = high/low values]
<ToleranceSize ts
    relative size of tolerance text
<ToleranceLow tl
    low tolerance value for tolerance type 2
<ToleranceHigh th
    high tolerance value for tolerance type 2
<Tolerance tv
    tolerance value for tolerance type 1
<Suffix i$
    dimension suffix ["0" = none, "1" = custom1, "2" = custom2, etc.]
<Prefix "j$
    dimension prefix ["0" = none, "1" = custom1, "2" = custom2, etc.]
<Font "fontname"
<Size s
    dimension text size
<Type t
    [0 = dimension, 1 = exploded dimension]
<Gap g
    distance between measured points and leader bottoms
<length l
    length of fixed-length leader lines
<fix fx
    [0 for variable-length leader lines, 1 for fixed-length
<OverShoot os
    distance between arrow tips and leader tops
<Arrowhead a
    arrowhead style; see arrow command for details
<Arrowsize as
<LinePosition lp
    [0 = arrows inside leaders, 1 = arrows outside leaders]
<Axis y
    [1 = horizontal, 2 = vertical]
}

```

Parameters for Ole Automation:

```

font: font for the dimension
textSize: the size of the dimension text
orientation: orientation of the text relative to the arrows;
    0=aligned with leader, 1 = perpendicular to leader, 2 = horizontal, 3=vertical,
precision: number of places past the decimal (fractional power of 2 for fractions)
dimFormat: text format;
    0=decimal, 1=fractional, 2=feet-inches(decimal), 3=feet-inches(fractional inches)
gapsize: distance between measured point and bottom of leader line (relative to text size;
gapsize=2.5 and textsize=2 gives a net gap of 5)
fixedLength: True = fixed leader length, False = variable leader length
    Note: fixedLength=True and gapsize cannot be used at the same time
length: length of leader line (also relative to text size; only used if fixedLength = True)
createAs: 0 = normal dimension, 1 = exploded dimension(grouped)
prefixIndex: dimension prefix; [0-5; 0=none]
suffixIndex: dimension suffix; [0-5; 0=none]

```

## DimDiameter

```
{
```

```

<Orientation o
    Text orientation [0 = aligned with arrows, 1 = perpendicular,
    2 = horizontal, 3 = vertical]
<Precision p
    Number of digits past the decimal in the dimension text
<Format f
    Text format [0 = 4.125, 1 = 4-1/8, 2 = 4'1.5", 3 = 4'1-1/2"]
<Location l
    Text location relative to arrows [0 = inside, 1 = outside]
<ToleranceType tt
    [0 = none, 1 = single value, 2 = high/low values]
<ToleranceSize ts
    relative size of tolerance text
<ToleranceLow tl
    low tolerance value for tolerance type 2
<ToleranceHigh th
    high tolerance value for tolerance type 2
<Tolerance tv
    tolerance value for tolerance type 1
<Suffix i$
    dimension suffix ["0" = none, "1" = custom1, "2" = custom2, etc.]
<Prefix "j$
    dimension prefix ["0" = none, "1" = custom1, "2" = custom2, etc.]
<Font "fontname"
<Size s
    dimension text size
<Type t
    [0 = dimension, 1 = exploded dimension]
<Arrowhead a
    arrowhead style; see arrow command for details
<Arrowsize as
<Axis y
    [0 = text and arrows inside,
    1 = external text and arrows; arrows connected by line
    2 = external text and single arrow
    3 = arrows inside, text outside]
}

```

Parameters for Ole Automation:

```

font: font for the dimension
textSize: the size of the dimension text
arrowSize: the size of the arrowheads
arrowType: the arrowhead style [1-12]
orientation: orientation of the text relative to the arrow;
    0=aligned with arrow, 1 = perpendicular to arrow, 2 = horizontal, 3=vertical, 4-7=reversed
    versions of 0-3
precision: number of places past the decimal (fractional power of 2 for fractions)
dimFormat: text format;
    0=decimal, 1=fractional, 2=feet-inches(decimal), 3=feet-inches(fractional inches)
textLocation: placement of text;
    0=aligned with arrow, 1=above arrow, 2=below arrow
createAs: 0 = normal dimension, 1 = exploded dimension(grouped)
toleranceType: 0=none, 1 = single-value, 2 = upper and lower value
tolerance: tolerance value for toleranceType=1
toleranceUpper: Upper tolerance value for toleranceType=2 (include the sign)
toleranceLower: Lower tolerance value for toleranceType=2 (include the sign)
toleranceTextSize: size of the tolerance text for toleranceType=2 (scaled by textsize)
prefixIndex: dimension prefix; [0-5; 0=none]

```

suffixIndex: dimension suffix; [0-5; 0=none]Default=1 ("x45°")  
axis: 0=text and arrows inside circle; 1 = text and arrows outside circle, diameter line through circle; 2=text and single arrow outside, pullout-style; 3=arrows inside, text outside

## Dimension

```
{
  <Orientation o
    Text orientation [0 = aligned with arrows, 1 = perpendicular, 2 = horizontal, 3 =
    vertical]
  <Precision p
    Number of digits past the decimal in the dimension text
  <Format f
    Text format [0 = 4.125, 1 = 4-1/8, 2 = 4'1.5", 3 = 4'1-1/2"]
  <Location l
    Text location relative to arrows [0 = inside, 1 = outside]
  <ToleranceType tt
    [0 = none, 1 = single value, 2 = high/low values]
  <ToleranceSize ts
    relative size of tolerance text
  <ToleranceLow tl
    low tolerance value for tolerance type 2
  <ToleranceHigh th
    high tolerance value for tolerance type 2
  <Tolerance tv
    tolerance value for tolerance type 1
  <Suffix i$
    dimension suffix ["0" = none, "1" = custom1, "2" = custom2, etc.]
  <Prefix "j$
    dimension prefix ["0" = none, "1" = custom1, "2" = custom2, etc.]
  <Font "fontname"
  <Size s
    dimension text size
  <Type t
    [0 = dimension, 1 = exploded dimension]
  <Gap g
    distance between measured points and leader bottoms
  <length l
    length of fixed-length leader lines
  <fix fx
    [0 for variable-length leader lines, 1 for fixed-length
  <OverShoot os
    distance between arrow tips and leader tops
  <Arrowhead a
    arrowhead style; see arrow command for details
  <Arrowsize as
  <LinePosition lp
    [0 = arrows inside leaders, 1 = arrows outside leaders]
  <Axis y
    [0 = Auto, 1 = Free, 2 = X, 3 = Y, 4 = Z]
}
```

Parameters for Ole Automation:

font: font for the dimension  
textSize: the size of the dimension text  
arrowSize: the size of the arrowheads  
arrowType: the arrowhead style [1-12]  
orientation: orientation of the text relative to the arrows;  
0=aligned with arrows, 1 = perpendicular to arrows, 2 = horizontal, 3=vertical, 4-  
7=reversed versions of 0-3



precision: number of places past the decimal (fractional power of 2 for fractions)  
dimFormat: text format;  
    0=decimal, 1=fractional, 2=feet-inches(decimal), 3=feet-inches(fractional inches)  
textLocation: placement of text;  
    0=between arrows, 1=above, 2=below, 3=left, 4=upper left, 5=lower left, 6=right, 7=upper right, 8 = lower right  
gapsize: distance between measured point and bottom of leader line (relative to text size; gapsize=2.5 and textsize=2 gives a net gap of 5)  
fixedLength: True = fixed leader length, False = variable leader length  
    note: fixedLength=True and gapsize cannot be used at the same time;  
length: length of leader line (also relative to text size; only used if fix = True)  
overSize: distance leader line extends past arrowtip (scaled by textsize)  
createAs: 0 = normal dimension, 1 = exploded dimension(grouped)  
axis: direction of measurement; 0=x only, 1=y only, 2=z only, 3=auto (depends on 3rd point), 4=free (measures actual distance between points 1 and 2)  
toleranceType: 0=none, 1 = single-value, 2 = upper and lower value  
tolerance: tolerance value for toleranceType=1  
toleranceUpper: Upper tolerance value for toleranceType=2 (include the sign)  
toleranceLower: Lower tolerance value for toleranceType=2 (include the sign)  
toleranceTextSize: size of the tolerance text for toleranceType=2 (scaled by textsize)  
prefixIndex: dimension prefix; [0-5; 0=none]  
suffixIndex: dimension suffix; [0-5; 0=none]

## DimExtend

```
{
  <Orientation o
    Text orientation [0 = aligned with arrows, 1 = perpendicular, 2 = horizontal, 3 =
    vertical]
  <Precision p
    Number of digits past the decimal in the dimension text
  <Format f
    Text format [0 = 4.125, 1 = 4-1/8, 2 = 4'1.5", 3 = 4'1-1/2"]
  <ToleranceType tt
    [0 = none, 1 = single value, 2 = high/low values]
  <ToleranceSize ts
    relative size of tolerance text
  <ToleranceLow tl
    low tolerance value for tolerance type 2
  <ToleranceHigh th
    high tolerance value for tolerance type 2
  <Tolerance tv
    tolerance value for tolerance type 1
  <Suffix i$
    dimension suffix ["0" = none, "1" = custom1, "2" = custom2, etc.]
  <Prefix "j$
    dimension prefix ["0" = none, "1" = custom1, "2" = custom2, etc.]
  <Font "fontname"
  <Size s
    dimension text size
  <Type t
    [0 = dimension, 1 = exploded dimension]
  <Gap g
    distance between measured points and leader bottoms
  <OverShoot os
    distance between arrow tips and leader tops
  <length l
    length of fixed-length leader lines
  <fix fx
```

```

    [0 = variable-length leader lines, 1 = fixed-length]
<Arrowhead a
    arrowhead style; see arrow command for details
<Arrowsize as
    size of arrowhead
<LinePosition lp
    [0 = arrows inside leaders, 1 = arrows outside leaders]
<Axis y
    [0 = Auto, 1 = Free, 2 = X, 3 = Y, 4 = Z]
}

```

Parameters for Ole Automation:

```

font: font for the dimension
textSize: the size of the dimension text
arrowSize: the size of the arrowheads
arrowType: the arrowhead style [1-12]
orientation: orientation of the text relative to the arrows;
    0=aligned with arrows, 1 = perpendicular to arrows, 2 = horizontal, 3=vertical, 4-
    7=reversed versions of 0-3
precision: number of places past the decimal (fractional power of 2 for fractions)
dimFormat: text format;
    0=decimal, 1=fractional, 2=feet-inches(decimal), 3=feet-inches(fractional inches)
textLocation: placement of text; 0=between arrows, 1=above, 2=below
gapSize: distance between measured point and bottom of leader line (relative to text size;
gapSize=2.5 and textSize=2 gives a net gap of 5)
fixedLength: True = fixed leader length, False = variable leader length
    note: fixedLength=True and gapSize cannot be used at the same time;
length: length of leader line (scaled to text size; only used if fixedLength=True)
overSize: distance leader line extends past arrowtip (scaled by textSize)
createAs: 0 = normal dimension, 1 = exploded dimension(grouped)
axis: direction of measurement; 0=horizontal, 1=vertical
toleranceType: 0=none, 1 = single-value, 2 = upper and lower value
tolerance: tolerance value for toleranceType=1
toleranceUpper: Upper tolerance value for toleranceType=2 (include the sign)
toleranceLower: Lower tolerance value for toleranceType=2 (include the sign)
toleranceTextSize: size of the tolerance text for Type 2 (scaled by textSize)
prefixIndex: dimension prefix; [0-5; 0=none]
suffixIndex: dimension suffix; [0-5; 0=none]

```

## DimensionDistanceOnly

```

{
<Orientation o
    Text orientation [0 = aligned with arrows, 1 = perpendicular, 2 = horizontal, 3 =
    vertical]
<Precision p
    Number of digits past the decimal in the dimension text
<Format f
    Text format [0 = 4.125, 1 = 4-1/8, 2 = 4'1.5", 3 = 4'1-1/2"]
<Location l
    Text location relative to arrows [0 = inside, 1 = outside]
<ToleranceType tt
    [0 = none, 1 = single value, 2 = high/low values]
<ToleranceSize ts
    relative size of tolerance text
<ToleranceLow tl
    low tolerance value for tolerance type 2
<ToleranceHigh th
    high tolerance value for tolerance type 2
<Tolerance tv

```

```

    tolerance value for tolerance type 1
<Suffix i$
    dimension suffix ["0" = none, "1" = custom1, "2" = custom2, etc.]
<Prefix "j$
    dimension prefix ["0" = none, "1" = custom1, "2" = custom2, etc.]
<Font "fontname"
<Size s
    dimension text size
<Type t
    [0 = dimension, 1 = exploded dimension]
<Axis y
    [1 = horizontal, 2 = vertical]
}

```

Parameters for Ole Automation:

```

font: font for the dimension
textSize: the size of the dimension text
orientation: orientation of the text relative to the arrows;
    0=aligned with arrows, 1 = perpendicular to arrows, 2 = horizontal, 3=vertical, 4-
    7=reversed versions of 0-3
precision: number of places past the decimal (fractional power of 2 for fractions)
dimFormat: text format;
    0=decimal, 1=fractional, 2=feet-inches(decimal), 3=feet-inches(fractional inches)
createAs: 0 = normal dimension, 1 = exploded dimension(grouped)
axis: direction of measurement; 0=x, 1=y, 2=z, 3=auto, 4=free
toleranceType: 0=none, 1 = single-value, 2 = upper and lower value
tolerance: tolerance value for toleranceType=1
toleranceUpper: Upper tolerance value for toleranceType=2 (include the sign)
toleranceLower: Lower tolerance value for toleranceType=2 (include the sign)
toleranceTextSize: size of the tolerance text for Type 2 (scaled by textsize)
prefixIndex: dimension prefix; [0-5; 0=none]
suffixIndex: dimension suffix; [0-5; 0=none]

```

## DimProgress

```

{
<Orientation o
    Text orientation [0 = aligned with arrows, 1 = perpendicular,
    2 = horizontal, 3 = vertical]
<Precision p
    Number of digits past the decimal in the dimension text
<Format f
    Text format [0 = 4.125, 1 = 4-1/8, 2 = 4'1.5", 3 = 4'1-1/2"]
<Location l
    Text location relative to arrows [0 = inside, 1 = outside]
<ToleranceType tt
    [0 = none, 1 = single value, 2 = high/low values]
<ToleranceSize ts
    relative size of tolerance text
<ToleranceLow tl
    low tolerance value for tolerance type 2
<ToleranceHigh th
    high tolerance value for tolerance type 2
<Tolerance tv
    tolerance value for tolerance type 1
<Suffix i$
    dimension suffix ["0" = none, "1" = custom1, "2" = custom2, etc.]
<Prefix "j$
    dimension prefix ["0" = none, "1" = custom1, "2" = custom2, etc.]
}

```

```

<Font "fontname"
<Size s
    dimension text size
<Type t
    [0 = dimension, 1 = exploded dimension]
<Gap g
    distance between measured points and leader bottoms
<length l
    length of fixed-length leader lines
<fix fx
    [0 for variable-length leader lines, 1 for fixed-length]
<OverShoot os
    distance between arrow tips and leader tops
<Arrowhead a
    arrowhead style; see arrow command for details
<Arrowsize as
    size of arrowhead
<LinePosition lp
    [0 = arrows inside leaders, 1 = arrows outside leaders]
<Axis y
    [1 = horizontal, 2 = vertical]
}

```

Parameters for Ole Automation:

```

font: font for the dimension
textSize: the size of the dimension text
arrowSize: the size of the arrowheads
arrowType: the arrowhead style [1-12]
orientation: orientation of the text relative to the arrows;
    0=aligned with arrows, 1 = perpendicular to arrows, 2 = horizontal, 3=vertical, 4-
    7=reversed versions of 0-3
precision: number of places past the decimal (fractional power of 2 for fractions)
dimFormat: text format;
    0=decimal, 1=fractional, 2=feet-inches(decimal), 3=feet-inches(fractional inches)
textLocation: placement of text; 0=between arrows, 1=above, 2=below
gapsize: distance between measured point and bottom of leader line (relative to text size;
gapsize=2.5 and textsize=2 gives a net gap of 5)
fixedLength: True = fixed leader length, False = variable leader length
    note: fixedLength=True and gapsize cannot be used at the same time;
length: length of leader line (scaled to text size; only used if fixedLength=True)
overSize: distance leader line extends past arrowtip (scaled by textsize)
createAs: 0 = normal dimension, 1 = exploded dimension(grouped)
axis: direction of measurement; 0=horizontal, 1=vertical
toleranceType: 0=none, 1 = single-value, 2 = upper and lower value
tolerance: tolerance value for toleranceType=1
toleranceUpper: Upper tolerance value for toleranceType=2 (include the sign)
toleranceLower: Lower tolerance value for toleranceType=2 (include the sign)
toleranceTextSize: size of the tolerance text for Type 2 (scaled by textsize)
prefixIndex: dimension prefix; [0-5; 0=none]
suffixIndex: dimension suffix; [0-5; 0=none]

```

## DimRadius

```

{
<Color rval, gval, bval
    RGB color settings
<Layer n
    layer number [0-255]
<incomplete
    If this parameter is included, the command will wait for the user to either (a)set enough

```

points to complete the command or (b)end the command by pressing "Enter"

```

<Orientation o
    Text orientation [0 = parallel to arrows, 1 = perpendicular, 2 = horizontal, 3 = vertical]
<Precision p
    Number of digits past the decimal in the dimension text
<Format f
    Text format [0 = 4.125, 1 = 4-1/8, 2 = 4'1.5", 3 = 4'1-1/2"]
<Location l
    Text location relative to arrows [0 = inside, 1 = outside]
<ToleranceType tt
    [0 = none, 1 = single value, 2 = high/low values]
<ToleranceSize ts
    relative size of tolerance text
<ToleranceLow tl
    low tolerance value for tolerance type 2
<ToleranceHigh th
    high tolerance value for tolerance type 2
<Tolerance tv
    tolerance value for tolerance type 1
<Suffix i$
    dimension suffix ["0" = none, "1" = custom1, "2" = custom2, etc.]
<Prefix "j$
    dimension prefix ["0" = none, "1" = custom1, "2" = custom2, etc.]
<Font "fontname"
<Size s
    dimension text size
<Type t
    [0 = dimension, 1 = exploded dimension]
<Arrowhead a
    arrowhead style; see arrow command for details
<Arrowsize as
    size of arrowhead
<Axis y
    [0 = text and arrow inside, 1 = internal arrow; external text connected by line to arrow,
    2 = text and arrow outside, 3 = text and arrow outside; line to center from arrowhead
}

```

Parameters for Ole Automation:

```

font: font for the dimension
textSize: the size of the dimension text
arrowSize: the size of the arrowheads
arrowType: the arrowhead style [1-12]
orientation: orientation of the text relative to the arrow;
    0=aligned with arrow, 1 = perpendicular to arrow, 2 = horizontal, 3=vertical, 4-7=reversed
    versions of 0-3
precision: number of places past the decimal (fractional power of 2 for fractions)
dimFormat: text format;
    0=decimal, 1=fractional, 2=feet-inches(decimal), 3=feet-inches(fractional inches)
textLocation: placement of text;
    0=aligned with arrow, 1=above arrow, 2=below arrow
createAs: 0 = normal dimension, 1 = exploded dimension(grouped)
toleranceType: 0=none, 1 = single-value, 2 = upper and lower value
tolerance: tolerance value for toleranceType=1
toleranceUpper: Upper tolerance value for toleranceType=2 (include the sign)
toleranceLower: Lower tolerance value for toleranceType=2 (include the sign)
toleranceTextSize: size of the tolerance text for toleranceType=2 (scaled by textsize)
prefixIndex: dimension prefix; [0-5; 0=none]
suffixIndex: dimension suffix; [0-5; 0=none]Default=1 ("x45°")

```

axis: 0=text and arrows inside circle; 1 = text and arrows outside circle, diameter line through circle; 2=text and single arrow outside, pullout-style; 3=arrows inside, text outside

## DimRadProgress

```
{
  <Orientation o
    Text orientation [0 = normal, 1 = horizontal]
  <Precision p
    Number of digits past the decimal in the dimension text
  <Format f
    Text format [0 = 4.125, 1 = 4-1/8, 2 = 4'1.5", 3 = 4'1-1/2"]
  <Location l
    Text location relative to arrows [0 = inside, 1 = outside]
  <ToleranceType tt
    [0 = none, 1 = single value, 2 = high/low values]
  <ToleranceSize ts
    relative size of tolerance text
  <ToleranceLow tl
    low tolerance value for tolerance type 2
  <ToleranceHigh th
    high tolerance value for tolerance type 2
  <Tolerance tv
    tolerance value for tolerance type 1
  <Suffix i$
    dimension suffix ["0" = none, "1" = custom1, "2" = custom2, etc.]
  <Prefix "j$
    dimension prefix ["0" = none, "1" = custom1, "2" = custom2, etc.]
  <Font "fontname"
  <Size s
    dimension text size
  <Type t
    [0 = dimension, 1 = exploded dimension]
  <Gap g
    distance between measured points and leader bottoms
  <length l
    length of fixed-length leader lines
  <fix fx
    [0 for variable-length leader lines, 1 for fixed-length]
  <OverShoot os
    distance between arrow tips and leader tops
  <Arrowhead a
    arrowhead style; see arrow command for details
  <Arrowsize as
    size of arrowhead
}
```

Parameters for Ole Automation:

font: font for the dimension  
textSize: the size of the dimension text  
arrowSize: the size of the arrowheads  
arrowType: the arrowhead style [1-12]  
orientation: orientation of the text relative to the arrows;  
0=aligned with arrows, 1 = perpendicular to arrows, 2 = horizontal, 3=vertical, 4-7=reversed versions of 0-3  
precision: number of places past the decimal (fractional power of 2 for fractions)  
dimFormat: text format;  
0=decimal, 1=fractional, 2=feet-inches(decimal), 3=feet-inches(fractional inches)  
gapsize: distance between measured point and bottom of leader line (relative to text size;  
gapsize=2.5 and textsize=2 gives a net gap of 5)

fixedLength: True = fixed leader length, False = variable leader length  
 note: fixedLength=True and gapsize cannot be used at the same time;  
 length: length of leader line (scaled to text size; only used if fixedLength=True)  
 overSize: distance leader line extends past arrowtip (scaled by textsize)  
 createAs: 0 = normal dimension, 1 = exploded dimension(grouped)  
 toleranceType: 0=none, 1 = single-value, 2 = upper and lower value  
 tolerance: tolerance value for toleranceType=1  
 toleranceUpper: Upper tolerance value for toleranceType=2 (include the sign)  
 toleranceLower: Lower tolerance value for toleranceType=2 (include the sign)  
 toleranceTextSize: size of the tolerance text for Type 2 (scaled by textsize)  
 prefixIndex: dimension prefix; [0-5; 0=none]  
 suffixIndex: dimension suffix; [0-5; 0=none]

## DragCopy

```
{
}
```

## DragMove

```
{
}
```

## DragSelect

```
{
  <Type t
    [0 = normal, 1 = Shift, 2 = Ctrl, 3 = Ctrl+Shift]
}
```

## DrawingHandle

```
{
}
```

## DrawingInfo

```
{
}
```

## Drill

```
{
}
```

## Duplicate

```
{
  <type s
    [0 = original scale, 1 = changeable scale]
}
```

Parameters for Ole Automation:

fixedScale: True makes the copy at original scale; False scales the copy according to the distance the handles.

## Dwgin

```
{
  <filename "drawingname.ext"
}
```

Parameters for Ole Automation:

fileName: the name of the DWG file to import

## DwgOut

```
{
  <filename "drawingname.ext"
}
```

Parameters for Ole Automation:  
fileName: the name of the DWG file to export

## **Dxfln**

```
{  
  <filename "drawingname.ext"  
}
```

Parameters for Ole Automation:  
fileName: the name of the DXF file to import

## **DxfOut**

```
{  
  <filename "drawingname.ext"  
}
```

Parameters for Ole Automation:  
fileName: the name of the DXF file to export

## **Ellipse**

```
{  
  <type t  
    [0 = normal, 1 = vector, 2 = plane]  
}
```

Parameters for Ole Automation:  
createAs: 0=ellipse, 1 = vector ellipse, 2 = plane

## **EllipticalArc**

```
{  
  <type t  
    [0 = normal, 1 = vector]  
}
```

Parameters for Ole Automation:  
createAs: 0=arc, 1 = vector arc

## **EntitySelect**

```
{  
  <Type t1 - type of entity to select; see GetAttrib statement for types.  
  <Type t2  
  .  
  .  
  .  
}
```

## **EraseLast**

```
{  
}
```

## **Exit**

```
{  
}
```

## **Explode**

```
{  
}
```

## **Extend**

```
{  
  <SelectOnly s  
    0 can affect any line; 1 only will extend a selected line
```



```
}
Parameters for Ole Automation:
<selectOnly
    True can only extend a selected line; False can extend any line
```

## Extrude

```
{
    <Incomplete
        If this parameter is included, the command will wait for the user to either (a) set enough
        points to complete the command or (b) end the command by pressing "Enter"
    <Scale 0, 1.000
        This is always 1.000 for varying scale extrusion, or the final scale factor for fixed
        scale extrusion
    <Scale 1, sf1
        Scale factors 1-n are only used for varying scale extrusion
    <Scale 2, sf2
    <Scale 3, sf3
    <Scale n, sfn
    <Type t
        [0 = fixed, 1 = varying]
}
Parameters for Ole Automation:
    scale: the extrusion scale (for fixed-scale extrusion only)
        Note: to do a varied scale extrusion in Automation, use the ExtrudeVarying method
        described in the Ole Automation section.
```

## Fillet

```
{
    <Type t
        [0 = normal fillet, 1 = keep original lines]
    <Radius r
}
Parameters for Ole Automation:
    radius: fillet radius
    originalLines: True keeps the "tails" of the original lines; False deletes them
```

## FilletCorner

```
{
    <Radius r
    <NFace n
}
Parameters for Ole Automation:
    radius: radius of fillet
    nFacet: number of sides to approximate the fillet
```

## FilletEdge

```
{
    <Radius r1, r2
    <NFace n
}
Parameters for Ole Automation:
    radius1: radius at near end of edge
    radius2: radius at opposite end of edge
    nFacet: number of sides to approximate the fillet
```

## FillWideLine

```
{
}
```

## FitToAllWindows

```
{  
}
```

## FitToWindow

```
{  
}
```

## Gravity

```
{  
  <pointxyz x, y, z  
}
```

## GridOptions

```
{  
}
```

## GroupDefine

```
{  
}
```

## GroupExplode

```
{  
}
```

## Hammer

```
{  
  <Radius r  
  <Type t  
    [0 = round hammer, 1 = pointed hammer]  
  <Fix fx  
    [0 = hammered surface fixed to grid edges, 1 = free edges]  
}
```

Parameters for Ole Automation

hammerType: 0=round hammer, 1=pointed hammer

radius: radius of the hammer

hammerFreeEdge: True = surface edges not fixed to original boundary

False = surface edges fixed to original boundary

## Hatch

```
{  
  <Scale s  
    pattern scale  
  <Angle a  
    pattern angle  
  <Type t  
    hatch pattern: 0 = ANGLE, 1 = ANSI31, 2 = ANSI32, 11 = BRICK, etc.  
}
```

Parameters for Ole Automation:

scale: pattern scale

angle: pattern angle

patternType: hatch pattern; 0 = ANGLE, 1 = ANSI31, 2 = ANSI32, 11 = BRICK, etc.

## HatchFill

```
{  
  <Scale s  
    pattern scale  
  <Angle a
```

```
    pattern angle
<Type t
    hatch pattern: 0 = ANGLE, 1 = ANSI31, 2 = ANSI32, 11 = BRICK, etc.
}
```

Parameters for Ole Automation:

```
scale: pattern scale
angle: pattern angle
patternType: hatch pattern; 0 = ANGLE, 1 = ANSI31, 2 = ANSI32, 11 = BRICK, etc.
```

## HatchLine

```
{
  <Scale s
    pattern scale
  <Angle a
    pattern angle
  <Type t
    hatch pattern: 0 = ANGLE, 1 = ANSI31, 11 = BRICK, etc.
}
```

Parameters for Ole Automation:

```
scale: pattern scale
angle: pattern angle
patternType: hatch pattern; 0 = ANGLE, 1 = ANSI31, 2 = ANSI32, 11 = BRICK, etc.
```

## Help

```
{
}
```

## HelpIndex

```
{
}
```

## HelpUsing

```
{
}
```

## Hemisphere

```
{
  <Orientation o
    [0 = vertex, 1 = midpoint of side, 2 = pole]
  <NLatitude
    Number of sides around equator
  <NLongitude
    Number of sides from pole to equator
}
```

Parameters for Ole Automation:

```
orientation: determines the meaning of point 2; 0=vertex, 1=midpoint, 2=pole
nLatitude = number of facets from pole to equator
nLongitude = number of facets around the center
```

## HiddenEdge

```
{
}
```

## Hide

```
{
  <ShowLine sl
    [0 = no show, 1 = show]
  <ShowArrow sa
```

```

    [0 = no show, 1 = show]
<ShowDimension sd
    [0 = no show, 1 = show]
<ShowText st
    [0 = no show, 1 = show]
}

```

Parameters for Ole Automation:

```

showText: True = show text, False = hide text
showLines: True = show vector lines, False = hide vector lines
showArrow: True = show arrows, False = hide arrows
ShowDimension: True = show dimensions, False = hide dimensions

```

## HideCmd

```

{
  <ShowLine sl
    [0 = no show, 1 = show]
  <ShowArrow sa
    [0 = no show, 1 = show]
  <ShowDimension sd
    [0 = no show, 1 = show]
  <ShowText st
    [0 = no show, 1 = show]
}

```

Parameters for Ole Automation:

```

showText: True = show text, False = hide text
showLines: True = show vector lines, False = hide vector lines
showArrow: True = show arrows, False = hide arrows
ShowDimension: True = show dimensions, False = hide dimensions
rangeType: 0=entire view, 1=section

```

## HideSec

```

{
  <ShowLine sl
    [0 = no show, 1 = show]
  <ShowArrow sa
    [0 = no show, 1 = show]
  <ShowDimension sd
    [0 = no show, 1 = show]
  <ShowText st
    [0 = no show, 1 = show]
}

```

Parameters for Ole Automation:

```

showText: True = show text, False = hide text
showLines: True = show vector lines, False = hide vector lines
showArrow: True = show arrows, False = hide arrows
ShowDimension: True = show dimensions, False = hide dimensions

```

## HpglIn

```

{
  <Filename "Filename.ext"
}

```

Parameters for Ole Automation:

```

fileName: name of the HPGL file to import

```

## IgesIn

```

{
  <Filename "Filename.ext"
}

```

Parameters for Ole Automation:  
fileName: name of the IGES file to import

## IgesOut

```
{  
  <Filename "Filename.ext"  
}
```

Parameters for Ole Automation:  
fileName: name of the IGES file to export

## IncVDis

```
{  
}
```

## InfoBox

```
{  
}
```

## InfoBoxBar

```
{  
}
```

## Interfere

```
{  
}
```

## Intersect-1

```
{  
}
```

## Intersect-2

```
{  
}
```

## Join

```
{  
  <SelectOnly s  
    [0 = only selected objects, 1 = all objects in range box]  
  <Endpoint i  
    [0 = all enclosed points, 1 = endpoints only]  
  <2DRange r  
    [0 = 3D range box, 1 = 2D range box]  
}
```

Parameters for Ole Automation:  
endpointOnly: True=joins only the endpoints of the entities in the region, False=joins all points in the region, even if they are not endpoints  
selectOnly: True=affects only selected entities, False=affects all entities in the region  
range2D: True=use 2D range, False=use 3D selection range

## LayerOptions

```
{  
}
```

## LayerSave=ID\_SAVELAYER

```
{  
  <LayerSelected n1  
  <LayerSelected n2  
  <LayerSelected n3
```

```
<LayerSelected n...  
<Filename "filename.ext"  
}
```

Parameters for Ole Automation:

fileName: name of drawing to save layers to  
list: text list of layer numbers, such as "001002030100" for 1, 2, 30, and 100

## Light

```
{  
}
```

## Line

```
{  
  <incomplete (optional)  
}
```

Parameters for Ole Automation:

incomplete: True allows user to set more points; False uses only the preset points

## LineAngle=ID\_LINEANGLE

```
{  
}
```

## LineDistance

```
{  
}
```

## LinePlane

```
{  
}
```

## Linesnap

```
{  
}
```

## LineStyleToolBox

```
{  
}
```

## LineToCurve

```
{  
}
```

## LoadBMP

```
{  
  <FileName "filename.ext"  
}
```

Parameters for Ole Automation:

fileName: name of BMP file to import

## LoadToolbox

```
{  
  <filename "filename.dct"  
}
```

Parameters for Ole Automation:

fileName: name of dct file to load

## MainToolBox

```
{
```

```
}
```

## MakePlane

```
{  
}
```

## MaterialEdit

```
{  
}
```

## MaterialList

```
{  
}
```

## MaterialToolBox

```
{  
}
```

## Merge

```
{  
  <Scale s  
    [0 = changeable scale, 1 = original scale]  
  <Type t  
    [0 = not selected after merge, 1 = selected after merge]  
  <Filename "path\filename.ext"  
}
```

Parameters for Ole Automation:

fileName: name of file to merge

fixedScale: True loads at original scale, false allows scale to be adjusted between handles

selectLoad: True selects the merged drawing once it is loaded; false merges without selecting it

## Midpoint

```
{  
}
```

## Mirror

```
{  
  <Axis a  
    [0 = x, 1 = y, 2 = z, 3 = custom]  
}
```

Parameters for Ole Automation:

axis: direction of mirror: 0 = x, 1 = y, 2 = z, 3 = custom

## Move

```
{  
  <Type t  
    [0 = changeable scale, 1 = fixed scale]  
}
```

Parameters for Ole Automation:

fixedScale: True moves the object without resizing it; False adjusts scale the object's size between the handles

## MoveDown

```
{  
}
```

## MoveLeft

```
{
```

```
}
```

## **MoveRight**

```
{  
}
```

## **MoveUp**

```
{  
}
```

## **New**

```
{  
}
```

## **NewWindow**

```
{  
}
```

## **ObjectRepeat - same as Array above**

```
{  
}
```

## **OffScreenBitmap**

```
{  
}
```

## **Open**

```
{  
  <Filename "filename.ext"  
}
```

Note: You can use an asterisk in place of the full path to the DesignCAD directory.

For example, if DesignCAD is installed in C:\Program Files\DesignCAD 3D and you want to open the drawing Myfile.dw3 in that directory, you can use <Filename "\*"Myfile.dw3" as the parameter for the Open command, instead of the more cumbersome <Filename "C:\Program Files\DesignCAD 3D\Myfile.dw3" If you don't specify a filename, or if DesignCAD can't find the file specified, the Open dialog box appears with a list of available files.

Parameters for Ole Automation:

fileName: name of file to be opened. The Note above applies here, also.

## **Options**

```
{  
}
```

## **Origin**

```
{  
}
```

## **OriginalSize**

```
{  
}
```

## **Ortho**

```
{  
}
```

## **OrthoLine**

```
{  
  <Incomplete (optional)
```



```
}
```

Parameters for Ole Automation:

incomplete: True allows the user to set extra points; False uses only the preset points

## Pan

```
{  
}
```

## Parallel

```
{  
}
```

## ParallelByDistance

```
{  
  <distance d  
}
```

Parameters for Ole Automation:

distance: the distance between the original and the parallel copy

## Paste

```
{  
  <Type t  
    0=Changeable scale (based on distance between handles 1 and 2  
    1=Fixed scale (always paste at original size)  
}
```

Parameters for Ole Automation:

fixedScale: True always pastes at original size, False pastes at adjustable scale

## Patch

```
{  
  <NPlane n, m  
    number of divisions across the width and length of the patch  
}
```

Parameters for Ole Automation:

nPlane1: number of facets "across" the patch (along first edge picked)

nPlane2: number of facets "along" the patch (along adjacent edge)

## PerpendicularTo

```
{  
}
```

## PerpendicularFrom

```
{  
  <Length l  
    length of perpendicular line  
}
```

Parameters for Ole Automation:

length: length of line to be drawn

## PerpendicularPlane

```
{  
  <Width w  
    length of a side of the perpendicular plane  
}
```

Parameters for Ole Automation:

width: length of each side of the plane

## Plane

```
{
```

```
<incomplete (optional)
}
Parameters for Ole Automation:
incomplete: True allows the user to set extra points; False uses only the preset points
```

## Planesnap

```
{
}
```

## PlaneSubtract

```
{
}
```

## PointMark

```
{
  <Type t
    [0 = cross, 1 = cross + circle, 2 = cross + square, 3 = cross+circle+square]
  <Size s
}
```

Parameters for Ole Automation:

```
pointSize: size of the mark
pointType: shape of the mark; 0=cross, 1=box-cross, 2=circle-cross, 3=box-circle-cross
```

## PointMove

```
{
}
```

## PointPolar

```
{
}
```

## PointRelative

```
{
}
```

## PointSelect

```
{
  <Type t
    [0 = normal, 1 = Shift, 2 = Ctrl, 3 = Ctrl+Shift]
}
```

## PointSelectMode

```
{
}
```

## PointXYZ

```
{
}
```

## PolygonCenter

```
{
  <Orientation o
    [0 = vertex, 1 = midpoint of side]
  <NSide s
    number of sides
  <Type t
    [0 = line, 2 = plane]
}
```

Parameters for Ole Automation:  
createAs: 0 = line, 1 = plane  
nSide: number of sides for the shape.  
orientation: location of point 2; 1=vertex, 2 = midpoint

## PolygonEdge=ID\_POLYGON\_EDGE

```
{  
  <NSide s  
    number of sides  
  <Type t  
    [0 = line, 2 = plane  
  }  
Parameters for Ole Automation:  
createAs: 0 = line, 1 = plane  
nSide: number of sides for the shape.
```

## Print

```
{  
}
```

## Pullout

```
{  
  <Orientation o  
    [0 = parallel, 1 = perpendicular, 2 = horizontal, 3 = vertical]  
  <Location l  
    [0 = in-line, 1 = above, 2 = below]  
  <Font "Fontname"  
  <Text "textcontent"  
  <Size s  
    Text size; if zero, uses default text size  
  <Arrowhead a  
    Arrowhead style; see Arrow command for details  
  <Arrowsize as  
    Size of arrowhead  
}  
Parameters for Ole Automation:  
font: text font  
arrowSize: size of the arrow  
arrowType: type of arrowhead  
textContent: contents of the balloon  
textSize: size of the text  
textLocation: text placement; 0=next to arrow, 1=above arrow, 2=below arrow
```

## Pyramid

```
{  
  <Orientation o  
    0=vertex, 1=midpoint  
  <NFace n  
  }  
Parameters for Ole Automation:  
orientation: 0=vertex, 1 = midpoint  
nFacet: number of sides of pyramid
```

## QShade

```
{  
  <ShowLine sl  
    [0 = no show, 1 = show]  
  <ShowArrow sa
```

```
[0 = no show, 1 = show]
<ShowDimension sd
  [0 = no show, 1 = show]
<ShowText st
  [0 = no show, 1 = show]
}
```

Parameters for Ole Automation:

```
showText: True = show text, False = hide text
showLines: True = show vector lines, False = hide vector lines
showArrow: True = show arrows, False = hide arrows
ShowDimension: True = show dimensions, False = hide dimensions
```

## **QShadeSec=ID\_QUICK\_SHADING\_2**

```
{
  <ShowLine sl
    [0 = no show, 1 = show]
  <ShowArrow sa
    [0 = no show, 1 = show]
  <ShowDimension sd
    [0 = no show, 1 = show]
  <ShowText st
    [0 = no show, 1 = show]
}
```

Parameters for Ole Automation:

```
showText: True = show text, False = hide text
showLines: True = show vector lines, False = hide vector lines
showArrow: True = show arrows, False = hide arrows
ShowDimension: True = show dimensions, False = hide dimensions
```

## **QuarterCircle**

```
{
  <Type t
    0=arc, 1=vector arc
}
```

Parameters for Ole Automation:

```
createAs: 0=arc, 1=vector arc
```

## **Quit**

```
{
}
```

## **Redo**

```
{
}
```

## **Redraw**

```
{
}
```

## **RedrawAll**

```
{
}
```

## **Regenerate**

```
{
}
```

## **RegenerateAll**

```
{  
}
```

## RemoveToolbox

```
{  
  <Toolboxname "name"  
    Displayed name of toolbox under View | Options  
}  
Parameters for Ole Automation:  
  name: the name of the toolbox
```

## RoundBox

```
{  
  <NFace n  
  <Radius r  
}  
Parameters for Ole Automation:  
  nfacet: number of facets to approximate each radius  
  radius: radius of edges
```

## Rotate

```
{  
  <Axis i  
    [0 = x, 1 = y, 2 = z, 3 = 2-point, 4 = line, 5 = plane]  
  <Angle a  
    Rotation Angle  
}  
Parameters for Ole Automation:  
  axis: 0=x, 1=y, 2=z, 3=2-point line(requires 2 points), 4=plane(requires 3 points)  
  angle: rotation angle
```

## Ruler

```
{  
}
```

## Run

```
{  
  <FileName "filename.ext"  
}  
Parameters for Ole Automation:  
  fileName: name of macro to execute
```

## RunX

```
{  
  <FileName "filename.exe"  
}
```

## Save

```
{  
}
```

## SaveAs

```
{  
  <SaveSelected ss  
    [0=save everything, 1=only save selected items]  
  <FileName "filename.ext"  
}  
Parameters for Ole Automation:
```

saveAs2D: True or False  
saveDouble: True or False  
selectOnly: True or False  
saveHidden: True or False  
fileName: name of file to be saved

## SaveBMP

```
{  
  <FileName "filename.ext"  
}
```

Parameters for Ole Automation:  
fileName: name of file to save

## SaveCurrentView

```
{  
  <Text "view name"  
}
```

Note: This command saves the current view angles and view distance as a named view setting in the Viewing Toolbox view list. This named view is saved along with DesignCAD's other custom settings in the Dcad97.ini file, and will continue to be available in other drawing sessions. Do not confuse this command with ViewSave, which saves the number of view windows, their sizes, the zoom factors and view angles for each view window, and other details in a separate file.

Parameters for Ole Automation:  
viewname: name of view to be saved.

## SaveSelected

```
{  
  <Filename "filename.ext"  
  <Version4 v  
    [0 = no, 1 = yes; a value of 1 saves the file in single-precision format compatible with  
    DesignCAD 3D version 4.0 (Dos version)]  
}
```

Parameters for Ole Automation:  
fileName: name of file to save

## ScrollBar

```
{  
}
```

## SectionCut

```
{  
}
```

## SectionDeleteCut

```
{  
}
```

## Segment

```
{  
  <NSegment ns  
}
```

Parameters for Ole Automation:  
nSegment: number of segments

## SelectAll

```
{  
}
```

## SelectDelete

```
{  
}
```

**SelectDuplicate** - same as Duplicate above

## SelectImageSource

```
{  
}
```

## SelectionFilter

```
{  
}
```

**SelectMirror** - same as Mirror above

**SelectMode** - same as PointSelectMode above

## SelectModeChange

```
{  
}
```

**SelectMove** - same as Move above

**SelectOrtho** - same as Ortho above

## SelectScale

```
{  
  <Scale xscale, yscale, zscale  
}  
Parameters for Ole Automation:  
  xScale:  
  yScale:  
  zScale:
```

## SelectScaleOrtho

```
{  
  <zoomfactor zf  
}  
Parameters for Ole Automation:  
  zoomFactor:
```

## SelectPrevious

```
{  
}
```

## SemiCircle

```
{  
  <Type t  
    [0=arc, 1=vector arc]  
}  
Parameters for Ole Automation:  
  createAs: 0=arc ,1=vector arc
```

## SendAllFiles

```
{  
}
```

## SendCurrentFile

```
{  
}
```

## SetColor

```
{  
  <color r, g, b  
}
```

## SetDrawingHandle - same as DrawingHandle above

```
{  
}
```

## SetGridCenter

```
{  
}
```

## SetHandle

```
{  
}
```

## SetView

```
{  
}
```

## SetViewerPoints

```
{  
}
```

## ShadeView

```
{  
  <ShowLine sl  
    [0 = no show, 1 = show]  
  <ShowArrow sa  
    [0 = no show, 1 = show]  
  <ShowDimension sd  
    [0 = no show, 1 = show]  
  <ShowText st  
    [0 = no show, 1 = show]  
}
```

Parameters for Ole Automation:

showText: True = show text, False = hide text

showLines: True = show vector lines, False = hide vector lines

showArrow: True = show arrows, False = hide arrows

ShowDimension: True = show dimensions, False = hide dimensions

## ShadeCommand=ID\_DCAD\_SHADE

```
{  
  <ShowLine sl  
    [0 = no show, 1 = show]  
  <ShowArrow sa  
    [0 = no show, 1 = show]  
  <ShowDimension sd  
    [0 = no show, 1 = show]  
  <ShowText st  
    [0 = no show, 1 = show]  
}
```



Parameters for Ole Automation:

showText: True = show text, False = hide text  
showLines: True = show vector lines, False = hide vector lines  
showArrow: True = show arrows, False = hide arrows  
ShowDimension: True = show dimensions, False = hide dimensions  
rangeType: 0= full view, 1=section

## ShadeSection=ID\_SHADING\_2

```
{  
  <ShowLine sl  
    [0 = no show, 1 = show]  
  <ShowArrow sa  
    [0 = no show, 1 = show]  
  <ShowDimension sd  
    [0 = no show, 1 = show]  
  <ShowText st  
    [0 = no show, 1 = show]  
}
```

Parameters for Ole Automation:

showText: True = show text, False = hide text  
showLines: True = show vector lines, False = hide vector lines  
showArrow: True = show arrows, False = hide arrows  
ShowDimension: True = show dimensions, False = hide dimensions

## ShowAttributes

```
{  
}
```

## ShowGrid

```
{  
}
```

## ShowHide

```
{  
}
```

## Sketch

```
{  
}
```

## Slice

```
{  
  <SelectOnly so  
    [0 = False, 1 = True]  
}
```

Parameters for Ole Automation:

selectOnly: True only slices selected objects, False slices entire drawing

## SmoothLine

```
{  
}
```

## SmoothOff

```
{  
}
```

## SmoothOn

```
{
```

```
}
```

## **SnapGrid**

```
{  
}
```

## **SnapSize - same as GridOptions above**

```
{  
}
```

## **SnapToolBox**

```
{  
}
```

## **SolidAdd**

```
{  
}
```

## **SolidDefine**

```
{  
}
```

## **SolidExplode**

```
{  
}
```

## **SolidIntersect**

```
{  
}
```

## **SolidSubtract**

```
{  
}
```

## **Sphere**

```
{  
  <Orientation o  
    [0 = vertex, 1 = midpoint of side, 2 = pole]  
  <NLatitude  
    Number of sides around equator  
  <NLongitude  
    Number of sides from pole to pole  
}
```

Parameters for Ole Automation:

orientation: determines the meaning of point 2; 0=vertex, 1=midpoint, 2=pole  
nLatitude = number of facets from pole to pole  
nLongitude = number of facets around the center

## **StatusBar**

```
{  
}
```

## **Stretch**

```
{  
  <2Drange r  
  <SelectOnly s  
}
```

Parameters for Ole Automation:

selectOnly: only stretches selected entities  
range2D: True creates a 2D selection rectangle, False creates a 3D selection region

## SurfaceConnect

```
{  
  <nbreak b  
    number of breaks between connected lines  
  <nsurf s  
    number of breaks along each selected line  
  <type t  
    [0 = line, 1 = curve, 2 = smooth]  
}  
Parameters for Ole Automation:  
  connectType: mesh method; 0 = straight, 1 = curved, 2 = smoothed  
  nSurface: number of breaks across the width of the mesh  
  nBreak: number of breaks between the front and rear of the mesh
```

## ShowToolbox

```
{  
  <Toolboxname "name"  
    Displayed name of toolbox under View | Options  
  <Visible v  
    [0 = show the toolbox, 1 = hide the toolbox]  
}  
Parameters for Ole Automation:  
  name: the name of the toolbox  
  show: True displays the toolbox, False hides the toolbox
```

## SurfaceArea

```
{  
}
```

## SurfaceIntersection

```
{  
}
```

## Sweep

```
{  
  <axis a  
    [0 = x, 1 = y, 2 = z, 3 = 2-point, 4 = line, 5 = plane]  
  <angle b  
    sweep angle  
  <ncopy nc  
    number of copies (NOT including the original)  
  <offset o  
    Distance of final copy from 1st copy along sweep axis  
}  
Parameters for Ole Automation:  
  nCopy: the number of copies of the original outline (including the original)  
  angle: sweep angle  
  offset: distance between the first and last copies, measured along the axis  
  axis: the center line of the sweep. 0=x, 1=y, 2=z, 3=2-point line, 4=existing line
```

## SymbolLoad

```
{  
  <Filename "symbol.dc"  
    symbol to be loaded  
  <Scale s
```

```

    [0 = original scale, 1 = changeable scale]
<Type t
    [0 = not selected after merge, 1 = selected after merge]
}

```

Parameters for Ole Automation:

```

fileName: the name of the file to merge
fixedScale: True merges the file at its original size, regardless of the distance between
handles; False rescales the merged file based on the distance between handles 1 and 2
selectLoad: True causes the merged objects to be selected immediately; False does not select
the merged items.

```

## SymbolExplode

```

{
}

```

## TangentBetween

```

{
}

```

## TangentFrom

```

{
}

```

## TangentTo

```

{
}

```

## Text2D

```

{
  <style st
    0 = normal, 1 = bold, 2 = italic, 3 = bold italic
  <justification
    0 = left, 1 = center, 2 = right
  <size s
    text size
  <angle a
    default text angle (if only one point is set)
  <font font$
    the full name of Windows font, ex. "Times New Roman"
  <text text$
    the text contents
  <type t
    0=normal text, 1=vector text
}

```

Parameters for Ole Automation

```

textContent: the text to be drawn
textSize: the height of the text
textStyle: 0=normal, 1=bold, 2=italic, 3=bold italic
textJust: 0=left-justified, 1=centered, 2=right-justified
font: font name
createAs: 0=normal text, 1=vector text

```

## Text=ID\_TEXT3D

```

{
  <style st
    0 = normal, 1 = bold, 2 = italic, 3 = bold italic
  <justification
    0 = left, 1 = center, 2 = right
  <size s
    text size

```

```

<angle a
    default text angle (if only one point is set)
<font font$
    the full name of Windows font, ex. "Times New Roman"
<text text$
    the text contents
<type t
    0=normal text, 1=vector text
}

```

Parameters for Ole Automation

```

textContent: the text to be drawn
textSize: the height of the text
textStyle: 0=normal, 1=bold, 2=italic, 3=bold italic
textJust: 0=left-justified, 1=centered, 2=right-justified
font: font name
createAs: 0=normal text, 1=vector text

```

## TextArc

```

{
  <style st
    0 = normal, 1 = bold, 2 = italic, 3 = bold italic
  <font font$
    the full name of Windows font, ex. "Times New Roman"
  <text text$
    the text contents
  <scale q
    the relative height of the text
  <type t
    0 = normal text, 1 = vector text
}

```

Parameters for Ole Automation:

```

textContent: the text to be drawn
textScale: the relative height of the text
textStyle: 0=normal, 1=bold, 2=italic, 3=bold italic
font: font name
createAs: 0=normal text, 1=vector text

```

## TextBlock

```

{
  <Style t
    0 = normal, 1 = bold, 2 = italic, 3 = bold italic
  <Justification j
    0 = left, 1 = center, 2 = right
  <Angle a
    the default text angle (if only one point is set)
  <font font$
    the full name of Windows font, ex. "Times New Roman"
  <Size s
    text size
  <Distance d
    line spacing; distance between the bottom of one line and the top of the next, relative to
    the text size. So, for "double spaced" lines, use 1.0
  <TextBegin
    Informs DesignCAD that the text block is defined in the macro, not by user input. Omit
    this if the user is to fill in the text himself.
  <Text text$
    A complete line of text to include in the text block
  <BlankLine

```

Use this parameter to specify a blank line of text in the block  
}

Parameters for Ole Automation:

textContent: the text to be drawn  
textSize: the height of the text  
textStyle: 0=normal, 1=bold, 2=italic, 3=bold italic  
textJust: 0=left-justified, 1=centered, 2=right-justified  
font: font name  
createAs: 0=normal text, 1=vector text

## **TextOutlineFill**

```
{  
}
```

## **TickMark**

```
{  
  <Segment s - number of divisions  
  <Distance d - distance along divisions  
  <Division div - number of small divisions for each large division  
  <LargeMark lm - size of large tickmark  
  <SmallMark sm - size of small tickmark  
  <Type t  
    0=set tickmarks by distance; 1=divide line into Segment pieces  
}
```

## **TileH**

```
{  
}
```

## **TileV**

```
{  
}
```

## **ToolBar**

```
{  
}
```

## **Torus**

```
{  
  <Orientation o  
    0=vertex, 1=midpoint  
  <Longitude l  
    number of segments around the torus  
  <Latitude m  
    number of facets around the tube's cross-section  
}
```

Parameters for Ole Automation:

orientation:  
nLatitude:  
nLongitude:

## **TruncatedCone**

```
{  
  <Orientation o  
    0=vertex, 1=midpoint  
  <NFace n  
}
```

Parameters for Ole Automation:

orientation:

nFacet:

## Trim1

```
{  
  <Type  
    [0 = Keep selected part, 1 = Trim shorter end]  
}
```

Parameters for Ole Automation:

trimShortEnd: True always trims shorter end, False always keeps the selected portion

## Trim2

```
{  
  <Type  
    [0 = Keep selected part, 1 = Trim shorter end]  
}
```

Parameters for Ole Automation:

trimShortEnd: True always trims shorter end, False always keeps the selected portion

## Trim3

```
{  
}
```

## TrimDouble

```
{  
}
```

## Tube=ID\_TUBE

```
{  
  <Orientation o  
    0=vertex, 1=midpoint  
  <NFace n  
}
```

Parameters for Ole Automation:

orientation:  
nFacet:

## Undo

```
{  
}
```

## Units

```
{  
  <Length l  
}
```

Parameters for Ole Automation:

distance: desired distance between two points

## UnWorkplane

```
{  
}
```

## VectorConvert

```
{  
}
```

## ViewChange

```
{  
  <angle ax, ay, az
```

```
    rotation angles about x, y, and z
<type t
  [0 = perspective, 1 = parallel]
<PRP px, py, pz
  [projection reference point (target)]
<VRP vx, vy, vz
  [viewer reference point (camera location)]
<Zoomfactor f
}
```

### **ViewerLeft**

```
{
}
```

### **ViewerRight**

```
{
}
```

### **ViewRead**

```
{
  <Filename "filename.ext"
}
```

Parameters for Ole Automation:  
fileName: name of view file to read

### **ViewRedo**

```
{
}
```

### **ViewSave=ID\_VIEW\_SAVE**

```
{
  <Filename "filename.ext"
}
```

Parameters for Ole Automation:  
fileName: name of view file to save

### **ViewToolBox**

```
{
}
```

### **Volume**

```
{
}
```

### **VPlane - Same as PerpendicularPlane above**

### **VrmlOut**

```
{
  <Filename "file.wrl"
}
```

Parameters for Ole Automation:  
filename: name of VRML file to export

### **Wall**

```
{
  <thickness t
}
```

Parameters for Ole Automation



thickness:

## WeldTwoObjects

```
{  
}
```

## WeldGroupOfObjects

```
{  
}
```

## Wmfln

```
{  
  <Filename "filename.wmf"  
}  
Parameters for Ole Automation:  
  fileName:
```

## WmfOut

```
{  
  <Filename "filename.wmf"  
}  
Parameters for Ole Automation:  
  fileName:
```

## Workplane

```
{  
}
```

## XyzIn

```
{  
  <Type t  
    [1 = connect with line, 2 = connect with curve, 3 = mark points with a small cross, 4 =  
    mark points with a small circle  
  <Size s  
    radius of circle or cross for type 3 or 4  
  <Filename "Filename.ext"  
}  
Parameters for Ole Automation:  
  fileName:  
  createAs: 1=connect with line, 2 = connect with curve, 3=small crosses 4=small circles  
  pointSize: radius of the circles or crosses
```

## Zoom

```
{  
  <zoomfactor zf  
}  
Parameters for Ole Automation:  
  zoomFactor: percentage to increase or decrease the drawing size on the screen  
  zoomStatic: if True, changes the actual size of the objects in the drawing.
```

## ZoomIn

```
{  
}
```

## ZoomOut

```
{  
}
```

**ZoomPrevious**

```
{  
}
```

**ZoomWindow**

```
{  
}
```

This section defines the various parameters and the possible values they can take. In the case of parameters that affect more than one macro command, the parameter values possible for each command are listed. The syntax shown takes the following form:

Parameter *variable* [variable range or description (RelevantMacroCmd1, RelevantMacroCmd2)]

When used within a BasicCAD program, all parameters appear between curly braces following a macro command, and each is preceded by a "<" character, like this:

```
>MacroCommand
{
    <Parameter1 variable1, variable2, variable3
    <Parameter2 variable4
}
```

*Variable\_x* can either be a numerical value, a "string of text in quotes", or a BasicCAD [variable] in square brackets.

<b>Parameters</b>	<b>Values</b>
2Drange <i>l</i>	[0=false; 1=true]
Angle <i>a</i>	[(Arc, Sweep, CircularRepeat, Text2D, Text3D)]
Angle <i>ax, ay, az</i>	[viewing angles (ViewChange)]
Arrowhead <i>i</i>	[0=none; 1=arrow; 2=circle; 3=slash (Dimension, DimAngle)]
Axis <i>l</i>	[0=z; 1=y; 2=x; 3=2-point; 4=line; 5=plane]
CG <i>x, y, z</i>	[a point on the solid]
Color <i>R,G,B</i>	[Red, Green and Blue color component values]
Depth <i>d</i>	[desired value for the chamfer depth]
EndPoint <i>i</i>	[0=no; 1=yes]
Filename " <i>filename.ext</i> "	[filename in "quotes" or a string variable [txtvar\$] in square brackets]
Font " <i>Times New Roman</i> "	[or [font\$] in brackets]
Gap <i>g</i>	[dimension gap size]
Gravity <i>x,y,z</i>	
Height <i>h</i>	
Incomplete	[no arguments. Use this parameter if you want the user to set some of the points for the command or set some of the commandline values]
Int1 <i>x, y, z</i>	[a point near the intersection]
Int2 <i>x1, y1, z1, x2, y2, z2</i>	[two points to pick the two lines that intersect]
Justification <i>i</i>	[0=left 1=center 2=right]
Latitude <i>n</i>	[number of faces along the polar axis of sphere or hemisphere]
Layer <i>n</i>	[layer number]
LayerSelected <i>n1,n2,n3,...</i>	[list of layer numbers to select]
Length <i>w</i>	[length of the perpendicular line (Perp2)]
Length <i>w</i>	[desired distance between the two points set (Unit)]
LinePlane <i>x1,y1,z1, x2,y2,z2</i>	[points for the line and the plane]
Linesnap <i>x,y,z</i>	[point to snap from]
Linetype <i>type, scale, width</i>	[type: [0-12] 0 = solid, 1 = dashed, etc.]

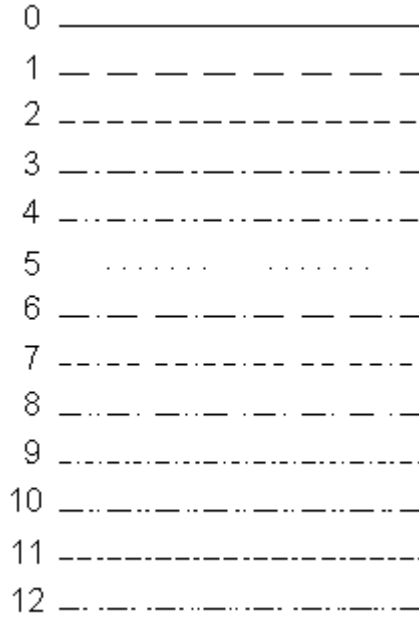

### Linetypes by the numbers

scale: line type scale (affects length of dashes and gaps);  
width: line thickness

Longitude <i>m</i>	[number of faces around the equator of sphere or hemisphere]
Midpoint <i>x,y,z</i>	[point on or near the line segment]
NBreak <i>n</i>	[number of breaks between connected lines]
NCopy <i>n1, n2, n3</i>	[number of copies (Array)]
NCopy <i>n</i>	[number of copies (Circular Array)]
NFace <i>n</i>	[number of faces (Cylinder, Cone, Fillet Edge, Fillet Corner)]
NPlane <i>n,m</i>	[number of planes across and down (Patch)]
NSide <i>n</i>	[number of sides (PolyCenter, PolyEdge)]
NSurf <i>n</i>	[number of planes along each curve or line (SurfaceConnect)]
Offset <i>d</i>	[distance of ending copy from beginning copy (Sweep, CircularRepeat)]
Orientation <i>i</i>	[0=vertex 1=midpoint 2=pole (Sphere, Hemisphere, Cylinder, Cone)]
Orientation <i>i</i>	[1=X; 2=Y; 3=Z; 4=Ortho; 5=any direction (Dimension)]
OverShoot <i>x</i>	[dimension overshoot (Dimension, DimAngle)]
Planesnap <i>x,y,z</i>	[point location near plane]
PointPOLAR <i>distance, angle, plane</i>	[dist >=0, plane:0=XY, 1=XZ, 2=YZ]
PointREL <i>dx,dy,dz</i>	
PointXYZ <i>x,y,z</i>	
PRP <i>x,y,z</i>	[projection reference point or target]
Radius <i>r</i>	[(Arc2, Fillet, FilletCorner, Hammer)]
Radius <i>r1,r2</i>	[(Fillet Edge)]
Save2D <i>i</i>	[0=no; 1=yes; 2=hide lines (SaveSelected)]
SaveHandle <i>i</i>	[0=no; 1=yes(SaveAs, SaveSelected)]
SaveHide <i>i</i>	[0=no; 1=yes]
Scale <i>qx,qy,qz</i>	[X, Y, and Z scale factors (SelectScale)]
Scale <i>q</i>	[(SelectZoom)]
SelectOnly <i>i</i>	[0=no; 1=yes]

Size <i>h</i>	[text height (Text2D, Text3D, Attribute, Dimension, DimAngle)]
Style <i>s</i>	[0=normal; 1=bold; 2=italic; 3=bold italic]
Text " <i>some text</i> "	[or [text\$] in square brackets]
Thick <i>t</i> [wall thickness]	
Type <i>t</i>	[0=perspective; 1=parallel (ViewChange)]
Type <i>t</i>	[0=normal; 1=vector; 2=plane (curves, arcs, circles, polygons)]
Type <i>t</i>	[0=trim normally; 1=trim short end (Trim1, Trim2)]
Type <i>t</i>	[0=text; 1=vector text (Text2D, Text3D)]
Type <i>t</i>	[0=normal; 1=static (Dimension, DimAngle)]
Type <i>t</i>	[0=normal; 1=reset drawing size (Zoom)]
Type <i>t</i>	[0=fixed scale; 1=varying scale (Extrude)]
Type <i>t</i>	[0=none; 1=arrow; 2=circle; 3=slash (Arrow)]
Type <i>t</i>	[0=line; 1=curve; 2=smooth (SurfaceConnect)]
Type <i>t</i>	[0=round; 1=sharp (Hammer)]
Type <i>t</i>	[0=normal; 1=Shift; 2=Ctrl; 3=Ctrl+Shift (PointSelect, DragSelect)]
Type <i>t</i>	[type of entity to be selected (EntitySelect)]
Version4 <i>l</i>	[0=no; 1=yes (SaveAs, SaveSelected)]
VRP <i>x,y,z</i>	[Viewer Reference Point (ViewChange)]
Width <i>w</i>	[Width of perpendicular plane (VPlane)]
ZoomFactor <i>q</i>	[zoom factor (Zoom)]

Each DesignCAD Macro command is followed by a Parameters section enclosed in curly braces "{}". The available parameters are listed below, showing possible values, with applicable notes in parentheses. If you are not sure which parameters to use with a DesignCAD macro command, record a macro using that command, then examine the macro file (\*.D3M) with a text editor.

With DesignCAD you can either use the hatch patterns provided with the program or define your own.

The following hatch patterns are provided with the software and can be selected with the Hatch command:

### Scaleable Hatch Patterns

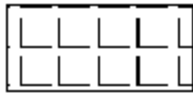

ANGLE

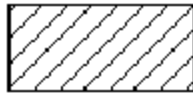

ANS131

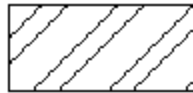

ANS132

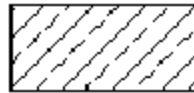

ANS133

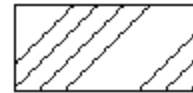

ANS134

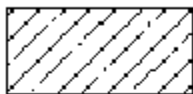

AND135

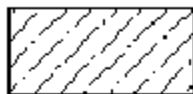

ANS136



ANS137



ANS138

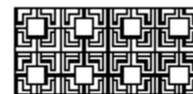

BLOCKS

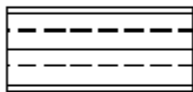

BRASS



BRICK

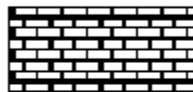

BRICK2

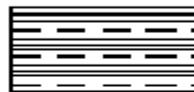

CLAY

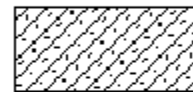

CONCRET



CORK

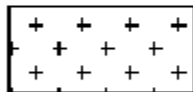

CROSS

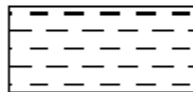

DASH

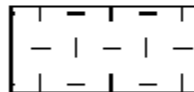

DECKING

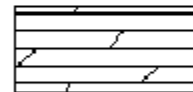

DOLOMITE

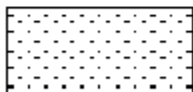

DOTS



EARTH

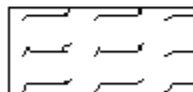

FLEX

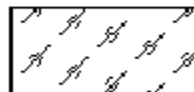

GLASS

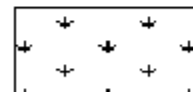

GRASS



GRATE

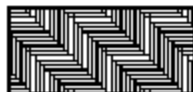

HBONE

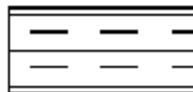

HEATRANS

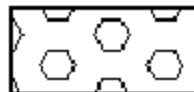

HEX



HONEY

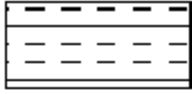

INSULATE

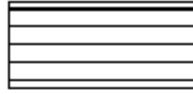

LINES

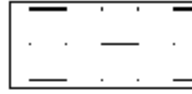

MUD

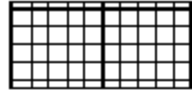

NET



NET3



NONSKID

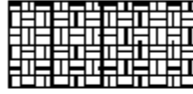

PARKET

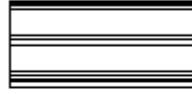

PLASTIC

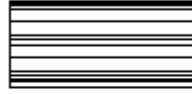

PLASTIC1

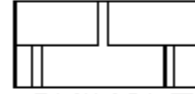

SHINGLES

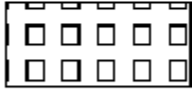

SQUARES



STARS

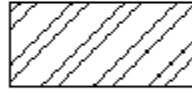

STEEL

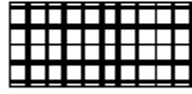

TILE



TRIANGLE



WEAVE

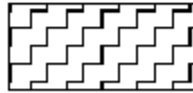

ZIGZAG

**Non-Scaleable Hatch Patterns**



WIN\_SOLID

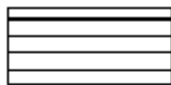

WIN\_HORIZONTAL

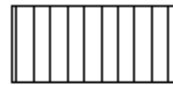

WIN\_VERTICAL

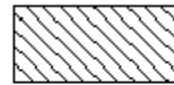

WIN\_FWDIAGONAL



WIN\_BKDIAGONAL

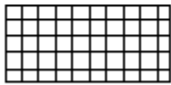

WIN\_CROSS



WIN\_DIAGROSS

The Hatch, Hatch Line, and Hatch Fill commands use hatch patterns found in the file DCHATCH.SYS. You can use your own hatch patterns with DesignCAD by adding them to this file. The file DCHATCH.SYS is an ASCII file that can be edited with a text editor or a word processor in ASCII mode. Be sure you have a second copy of the file DCHATCH.SYS before you modify it.

This file does not contain definitions for the "non-scaleable" hatch patterns such as WIN\_SOLID. These are defined by MS Windows.

The file DCHATCH.SYS consists of a series of hatch patterns. Each hatch pattern is in the following format:

```
Hatch Pattern Name
Number of Line Definitions          Pattern Scale for Preview
A   B   C   D   E   F1   F2   F3   F4   F5   F6
    (there will be a line of these values for each line definition)
```

The *Number of Line Definitions* indicates the number of separate line segments that make up the pattern. The *Pattern Scale for Preview* is the pattern scale that particular hatch pattern uses in the Preview box.

Line Definitions values:

- A. Angle (0=horizontal, 90=vertical)
- B. X offset of first occurrence (*relative to an arbitrary starting point*)
- C. Y offset of first occurrence (*relative to an arbitrary starting point*)
- D. X change from first to second occurrence. (*relative to B,C*)
- E. Y change from first to second occurrence. (*relative to B,C*)
- F. six numbers defining the line pattern:
  - 1) length on
  - 2) length off
  - 3) length on
  - 4) length off
  - 5) length on
  - 6) length off

"X" and "Y" are relative to the angle of the line. This means that if the angle is 90, then X is actually the relative vertical displacement, and Y is the relative horizontal displacement.

For example, the hatch pattern definition for the BRASS pattern is:

```
BRASS
2   45
0   0   0   0   20  40  0   0   0   0   0
0   0   10  0   20  10  5   0   0   0   0
```

There are two lines in the pattern. The first line definition is oriented at an angle of zero, so it is a horizontal line. It is a solid line, since there is only one non-zero value in the last six numbers. This first line starts at 0, 0 (an arbitrary position), and it will repeat 20 "units" above this line. This line ends 40 "units" from this starting point.

The next line is also a horizontal line, but it starts 10 units above the first line. It is a dashed line, repeating a pattern of 10 "on" and 5 "off."



A more complicated example is the BRICK2 pattern:

```
BRICK2
4      20
0      0      0      7      6      13      1      0      0      0      0
0      0      5      7      6      13      1      0      0      0      0
90     0      0      6      7      5      7      0      0      0      0
90     0      1      6      7      5      7      0      0      0      0
```

This pattern consists of 4 lines, 2 horizontal, and 2 vertical.

The first line is a horizontal, dashed line, repeating 13 on, and 1 off. It starts at 0,0, and will repeat at 7 units over and 6 units up. The second line is the same as the first, except that it starts 5 units above the first line.

The third line is a vertical line, starting at 0,0, repeating with 5 on and 7 off. Note that since it is vertical, the line actually repeats at 7 over and 6 up, not 6 over and 7 up. Because the fourth line is at a 90 degree angle, it starts at 1 unit to the left of the starting point.

If viewed by themselves, the four line segments will look something like this:

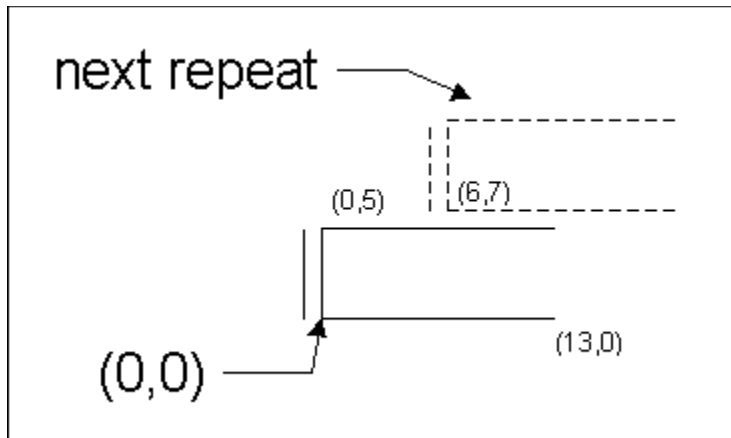

A few fonts have been included with DesignCAD 97. These True-Type fonts have been designed specifically for use with plotters. It is necessary to install these fonts under Windows 95 if you intend to use them, otherwise Windows 95 does not know that they are present.

On the Windows 95 START menu go to SETTINGS and select CONTROL PANEL. Double-click on the FONTS folder. In the Fonts window, click on the FILE menu, and select INSTALL NEW FONT.

Next, select the path to your DesignCAD 97 directory which contains the fonts you want to add.

Select the icons for the fonts you want to add from the LIST OF FONTS area. Click on the OK button.

A sample digitizer menu has been included to help users who have never used a digitizer with DesignCAD. This sample digitizer menu has been installed in your DesignCAD 97 directory and can be loaded following the instructions in the [Load Digitizer Menu](#) entry.

While you are using this digitizer menu, remember that it is just a sample. Using DesignCAD's digitizer commands, the possibilities for creating a customized digitizer menu are unlimited.

[Introduction](#)

[DesignCAD Application Properties:](#)

[DesignCAD Application Methods:](#)

[Predefined Object Classes for the DesignCAD Document Class:](#)

[Document Properties:](#)

[Document Methods:](#)

DesignCAD 97 exposes two objects for use with OLE Automation: The DesignCAD Document Object, and the DesignCAD Application Object. Before you can use these objects, you must declare them, either in a Basic Module or in the subroutine that uses them:

These forms are appropriate for use in a module:

```
Global Dcad3 As Object
Global Dc3App as Object
```

These forms are appropriate for use in a subroutine:

```
Dim Dcad3 As Object
Dim Dc3App as Object
```

Here is a sample module, DECLARE.BAS, which declares the objects and also contains some other useful functions which determine the Red, Green, and Blue components of a long integer representing a Windows color:

```
Global Dcad3 As Object
Global Dc3App As Object

Private Function RedVal(RGBColor As Long) As Long
'returns the RED component of a Long color value
RedVal = RGBColor And &HFF
End Function

Private Function GrnVal(RGBColor As Long) As Long
'returns the GREEN component of a Long color value
GrnVal = (RGBColor \ 256) And &HFF
End Function

Private Function BluVal(RGBColor As Long) As Long
'returns the BLUE component of a Long color value
BluVal = (RGBColor \ 65536) And &HFF
End Function
```

The names Dcad3 and Dc3App are not critical; you may use any names you wish to declare these objects. Later, in one of your subroutines, you must initialize each object as an instance of a DesignCAD application or document. Any of the following lines may be used to initialize your DesignCAD object:

```
Set Dc3App = GetObject (, "designcad.Application")
Set Dcad3 = GetObject(, "designcad.Document")
'the above two methods assume DesignCAD is already running.

Set Dcad3 = GetObject("filename.ext", "designcad.Document")
'This means can be used to open a specific drawing
```

```
Set Dcad3 = CreateObject ("designcad.Document")
Set Dc3App = CreateObject ("designcad.Application")
'use these to create new instances of DesignCAD.

Set Dc3App = Designcad.Application
'If DesignCAD is already open, this will point to the
'application.

Set Dcad3 = Dc3App.ActiveDocument
'This will point to the currently active document in the
'application
```

This document will assume in all examples that you have declared Dcad3 as your document object, or Dc3App as your application object.

## ActiveDocument

Description: The currently active document in DesignCAD

Example (assumes you have already declared Dcad3 as an object elsewhere):

```
Set Dcad3 = Dc3App.ActiveDocument
```

## Height

Data Type: Integer

Description: Sets the height of the DesignCAD window

Example:

```
Dc3App.Height = 400 'sets DesignCAD to '400 'pixels high
```

## Left

Data Type: Integer

Description: Sets the leftmost pixel value for the DesignCAD window

Example:

```
Dc3App.Left = 100 'puts DesignCAD 100 pixels 'from the left  
edge of the 'screen
```

## Top

Data Type: Integer

Description: Sets the top pixel location for the DesignCAD application window

Example:

```
Dc3App.Top = 0 'puts DesignCAD at the top of 'the screen
```

## UserControl

Data Type: Boolean

Description: Determines whether the user is allowed to access DesignCAD commands manually

Example:

```
Dc3App.UserControl = False  
'disables the DesignCAD menu and keystroke commands
```

## Visible

Data Type: Boolean

Description: Determines DesignCAD's visibility

Example:

```
Dc3App.Visible = True 'makes DesignCAD visible to 'the user
```

## Width

Data Type: Integer

Description: Sets the width of the DesignCAD window

Example:

```
Dc3App.Width = 500 'sets DesignCAD to 500 'pixels wide
```

## BringToTop

Description: Makes DesignCAD the topmost application, so that it is in front of all other applications

Example:

```
Dc3App.BringToTop
```

## InitializeDCAD iniFile as String

Data Type: Boolean

Description: Initializes the DesignCAD application for use with OLE Automation. **This should be called only if you use CreateObject to start a fresh instance of the DesignCAD application.**

**Note:** At this time, you should always use the empty string "" for iniFile. You can use any string you like, but the value will be ignored.

---

Example:

```
Set Dc3App = CreateObject ("designcad.Application")  
Dc3App.InitializeDCAD ""
```

## New

Description: starts a fresh document in the DesignCAD application

Example:

```
Dc3App.New
```

## Open FileName As String

Description: opens an existing drawing file

Example:

```
Dc3App.Open "c:\progra~1\Design~1\Samples\MySample.dc"
```

## Quit

Description: closes the DesignCAD application

Example:

```
Dc3App.Quit
```

## ShowWindow nCmdShow as Boolean

Description: Hides or shows the DesignCAD application

Example:

```
Dc3App.ShowWindow True  
MsgBox "application visible"  
Dc3App.ShowWindow False  
MsgBox "application hidden"
```



## AutoPoint

Description: Generic holder for XYZ point values

### AutoPoint Properties:

.x - Type Double - the X value of a point in the drawing  
.y - Type Double - the Y value of a point in the drawing  
.z - Type Double - the Z value of a point in the drawing

Example: draw a circle with center point at (25, 0, 10)

```
Dim dcpoint as Object
Set dcpoint = Dcad3.AutoPoint
dcpoint.x = 25
dcpoint.y = 0
dcpoint.z = 10
Dcad3.SetPoint dcpoint.x, dcpoint.y dcpoint.z
Dcad3.Circle4, False
```

## AutoParameter

Description: Generic holder for command parameters

### AutoParameter Properties:

alignment - Integer  
angle - Single  
arrowSize - Single - arrowhead size  
arrowType - Integer - arrowhead type  
axis - Integer - axis for rotate/spiral/mirror  
balloonSize - Single - size of balloon  
companyName - String  
connectType - Integer - smooth, curved, or straight  
createAs - Integer  
date - String  
depth - Single - chamfer depth  
dimFormat - Integer  
distance - Single - length of perp line  
endpointOnly - Boolean - flag for Join Endpoints command  
fileName - String  
fixedScale - Integer  
gapSize - Single  
hammerFreeEdge - Boolean  
hammerType - Integer - spherical or pointed  
length - Single  
nBreak - Integer - number of breaks in between c.s. copies  
nCopy - Integer - sweep/circular array command count  
nFacet - Integer - sides of a cylinder/fillet corner  
nLongitude - Integer - faces along a "longitude" line (pole to pole)  
nLatitude - Integer - faces along a "latitude" line (around equator)  
nPlane1 - Integer - number of facets across the patch (width)  
nPlane2 - Integer - number of facets along the patch (length)  
nRepCopy1 - Integer  
nRepCopy2 - Integer  
nRepCopy3 - Integer  
nSegment - Integer - number of segments for the segment command.  
nSide - Integer  
nSurface - Integer - number of faces across each copy  
offset - Single - dimension offset, spiral offset  
orientation - Integer

originalLines - Boolean  
 oversize - Single  
 pointSize - Single  
 pointType - Integer  
 precision - Integer - numerical/angular displayed precision  
 radius - Single  
 radius1 - Single - fillet radius, first rad. for fillet edge  
 radius2 - Single - second radius for fillet edge  
 range2D - Boolean  
 saveAs2D - Boolean  
 saveDouble - Boolean - save drawing with double precision?  
 saveHidden - Boolean  
 selectLoad - Boolean  
 selectOnly - Boolean - flag for several commands  
 serialNo - String  
 textContent - String - contents of text/attribute/text arc, etc.  
 textJust - Integer - text justification (left, center, right)  
 textLocation - Integer - dimension text location  
 textScale - Single - text scale  
 textSize - Single - text height  
 textStyle - Integer - text style (bold, italic, etc.)  
 thickness - Single - wall thickness  
 time - String  
 trimShortEnd - Boolean  
 userName - String  
 viewName - String  
 width - Single  
 xScale - Single -scale factor for sel. scale command  
 yScale - Single - scale factor for sel. scale command  
 zoomFactor - Single  
 zoomStatic - Boolean  
 zScale - Single - scale factor for sel. scale command

Example: Draw some text at the origin

```

Dim Param as Object
Set Param = Dcad3.AutoParameter
Dim MyText as Text
Dim TSize as Single
Dim TextLoc as Integer
MyText = "This is a string at the origin"
TSize = 4.5
TextLoc = 2
Param.textContent = MyText
Param.textSize = Tsize
Param.textLocation = TextLoc
Dcad3.Text3D, Param, False
  
```

## AutoEntity

Description: Generic holder for Entity parameters

### AutoEntity Properties:

Color - Long  
 entityType - Integer (read\_only)  
 group - Integer  
 ID- Long (read\_only)  
 Layer - Integer  
 LineScale - Single  
 LineThickness - Single  
 LineType - Integer  
 mark - Integer --0=not selected, 1=selected  
 MaterialIndex - Integer

nPoints - Integer (read\_only)  
smooth - Integer  
solid - Integer (read\_only)

Example: Draw a sphere, then reproduce each of the grid lines forming its ribs

```
'Setup code
Dim Dcad3 As Object
Set Dcad3 = GetObject(, "designcad.Document")
Dim Params As Object
Dim dcpoint As Object
Dim Enty As Object
Set Params = Dcad3.AutoParameter
Set dcpoint = Dcad3.AutoPoint
'Make the DesignCAD window visible and active
Dcad3.BringToTop
'Draw the sphere
Params.orientation = 0
Params.nLatitude = 10
Params.nLongitude = 15
Dcad3.Setpoint 0, 0, 0
Dcad3.Setpoint 20, 0, 0
Dcad3.Sphere Params, False
'check each entity in the drawing
Dim k As Integer
'the count runs from zero to NumberOfEntities - 1
For k = 0 To Dcad3.GetEntityCount - 1
    'retrieve the information for each entity
    Set Enty = Dcad3.AutoEntity(k)
    'If the entityType = 32, it is a grid 'header, and has no
    useable point 'information. Get the next one.
    If Enty.entityType = 32 Then
        Set Enty = Dcad3.AutoEntity(k + 1)
    End If
    Dim n As Integer
    'retrieve the points for valid entities. The 'count runs
    from zero to NumberOfPoints - 1
    For n = 0 To Enty.nPoints - 1
        Enty.Getpoint n, dcpoint
        'set a matching point further out on 'the Z axis.
        Dcad3.Setpoint dcpoint.x,dcpoint.y,dcpoint.z+40
    Next
    'Draw a line through the points for each 'grid line.
    Dcad3.Lines False
Next
```

## AutoEntity Methods:

GetPoint PointIndex as Integer, dcpoint as AutoPoint

Description: Gets the indexed point and stores the XYZ values in the AutoPoint object

SetPoint PointIndex as Integer, dcpoint as AutoPoint

Description: Sets the indexed point to the values stored in the AutoPoint object

Example:

```
Dim Enty as object
Dim dcpoint as object
set dcpoint = Dcad3.AutoPoint
Dim n as Long
n = Dcad3.GetEntityCount-1
'.
'.   Draw some stuff
'.
Set Enty = Dcad3.AutoEntity(n)
Enty.Getpoint 0, dcpoint
'Print the location of the first point of the 'last item:
MsgBox dcpoint.x & ", " & dcpoint.y & ", " & dcpoint.z
dcpoint.x = dcpoint.x + 20
dcpoint.y = dcpoint.y +5
dcpoint.z = dcpoint.z - 10
Enty.Setpoint 0, dcpoint
Dcad3.RegenerateAll
```

## AngDimPrecision

Data Type: Integer

Description: sets the number of digits of precision displayed in the dimension text

Example:

```
Dcad3.AngDimPrecision = 2
```

## Application

Description: returns a pointer to the DesignCAD Application

Example:

```
Dim Dc3App As Object
Dim Dc3Doc As Object
Set Dc3Doc = CreateObject ("designcad.Document")
Dc3Doc.InitializeDCAD ""
Set Dc3App = Dc3Doc.Application
```

## ArrowSize

Data Type: Double

Description: Size of the arrowhead for an Arrow entity

Example:

```
Dcad3.ArrowSize = 1.5
```

## BackgroundColor

Data Type: Long

Description: sets the "paper" color that DesignCAD draws on

Example:

```
Dcad3.BackgroundColor = RGB(0, 0, 0)
```

## Color

Data Type: Long

Description: This sets the current drawing color for DesignCAD 97

Example:

```
Dcad3.Color = RGB(0,255,0) 'sets current color 'to green
```

## CoordinateSystem

Data Type: Integer

Description: Sets Left- or Right-hand coordinate system

Range: -1 or 1

-1=Left-hand system (in Front view, positive Z goes into the monitor)

1=Right-hand system (in Front view, positive Z comes out of the monitor)

Example:

```
Dcad3.CoordinateSystem = -1 'set left-hand system
```

## Cursor3DXColor

Data Type: Long

Description: sets the color of the X-axis of the 3D cursor

### **Cursor3DYColor**

Data Type: Long

Description: sets the color of the Y-axis of the 3D cursor

### **Cursor3DZColor**

Data Type: Long

Description: sets the color of the Z-axis of the 3D cursor

### **CursorColor**

Data Type: Long

Description: sets the color of the "x"-shaped cursor in 2D Drafting Mode

Example:

```
Dcad3.CursorColor = RGB( 0, 0, 255)
```

### **CursorMoveMode**

Data Type: Integer

Description: Determines whether the cursor step size is figured relative to the drawing or to the screen.

Range: 1 to 2

1=relative to screen (cursor moves same distance across screen regardless of zoom)

2=relative to drawing (cursor moves same number of drawing units regardless of zoom)

Example:

```
Dcad3.CursorMoveMode = 2
```

### **DimArrowheadScale**

Data Type: Double

Description: Size of dimension arrowheads as a percentage of TextSize

Example:

```
Dcad3.DimArrowheadScale = 0.75 'sets arrowhead to '3/4 of the text size
```

### **DimArrowheadType**

Data Type: Integer

Description: sets style of arrowhead for dimensions and for arrows

Example:

```
Dcad3.DimArrowheadType = 5
```

### **DimensionColor**

Data Type: Long

Description: Default Color for dimensions

Example:

```
Dcad3.DimensionColor = RGB(0,0,128)
```

### **DimensionGap**

Data Type: Double

Description: Gap between measured points and start of leader lines

Example:

```
Dcad3.DimensionGap = 1.0
```

## DimensionLayer

Data Type: Integer

Description: Default layer for dimensions

Example:

```
Dcad3.DimensionLayer = 3
```

## DimensionOvershoot

Data Type: Double

Description: Amount of overshoot for dimension leader lines

Example:

```
Dcad3.DimensionOvershoot = 0.5
```

## DimensionTextSize

Data Type: Double

Description: Default dimension text size. If this value is set to zero, Dimension text is drawn at the default size for normal text.

Example:

```
Dcad3.DimensionTextSize = 0.75
```

## DimensionType

Data Type: Integer

Description: sets the default Dimension format

Range: 0-3

0=decimal units

1=fractional units

2=feet and decimal inches (one unit = one foot)

3=feet and fractional inches

Example:

```
Dcad3.DimensionType = 3
```

## DrawingUnit

Data Type: Single

Description: internal scale factor used to measure distances. Normally you will not want to change this except to automatically switch the drawing scale between feet and metric units.

Example: convert a drawing in feet to centimeters

```
Size = Dcad3.DrawingUnit
```

```
Dcad3.DrawingUnit = Size * 30.48 'converts feet to 'centimeters - one foot equals  
30.48cm.
```

## EnableCrosshair

Data Type: Boolean

Description: Toggles crosshair off/on

Example:

```
Dcad3.EnableCrosshair = True
```

## FilledWideLine

Data Type: Boolean

Description: Toggles wide line fill on/off. The effects of this setting are only visible in 2D

Drafting Mode.

Example:

```
Dcad3.FilledWideLine = True
```

## FontName

Data Type: String

Description: Name of the windows font to use for text

Example:

```
Dcad3.FontName = "Courier New"
```

## \*\*Fullname

Data type: String

Description: Returns the full path and program name.

Example:

```
Dim PathToDcad as String  
PathToDcad = Dcad3.Fullname  
'PathToDcad="D:\Program Files\DesignCAD 97\DCAD97.exe"
```

## GridColor

Data Type: Long

Description: sets the display grid color

Example:

```
Dcad3.GridColor = RGB(255 ,0, 0)
```

## GridSize

Data Type: Single

Description: Size of display grid segments in drawing units

Example:

```
Dcad3.GridSize = 5 'grid lines are 5 units apart
```

## GridType

Data Type: Integer

Description: current grid style

Range: 1 to 3

1=XY grid

2=YX grid

3=XZ grid

Example:

```
Dcad3.GridType=3 'sets up grid to lie "flat on the "ground" in the XZ plane
```

## Handle1X

## Handle1Y

## Handle1Z

Data Type: Double

Description: X,Y, and Z values for the primary drawing/selection handle

## Handle2X



## Handle2Y

## Handle2Z

Data Type: Double

Description: X, Y, and Z values for the secondary drawing/selection handle

## Handle3X

## Handle3Y

## Handle3Z

Data Type: Double

Description: X, Y, and Z values for the third drawing/selection handle

## HandleColor

Data Type: Long

Description: sets the color used to display selection handles

## HiliteColor

Data Type: Long

Description: sets the color used to display selected objects

Example:

```
Dcad3.HiliteColor = RGB(128,255,128)
```

## Layer

Data Type: Integer

Description: sets the current drawing layer

Range: 0 to 255

Example: Draw a box in every layer

```
Dim i As Integer
Dim j As Integer
For i = 0 To 15
    For j = 0 To 15
        Dcad3.Layer = i * 16 + j
        Dcad3.Setpoint 4 * i, 4 * j, 0
        Dcad3.Setpoint 4 * i + 3, 4 * j + 3, 0
        Dcad3.Box
    Next
Next
```

## LCursorStepSize

Data Type: Single

Description: Large cursor step size (using arrow keys)

Example:

```
Dcad3.LCursorStepSize = 4.0
```

## LineScale

Data Type: Single

Description: Sets the relative scaling for the repeating patterns of gaps and dashes

Example:

```
Dcad3.LineScale = 4
```

## LineThickness

Data Type: Single

Description: the default line thickness (only displayed in 2D Drafting Mode)

Example:

```
Dcad3.LineThickness = 0.125 'set line thickness 'to 1/8 drawing unit
```

## LineType

Data Type: Integer

Description: Sets the line type, where 0 is solid, 1 is dashed, etc.

Range: 0 to 12

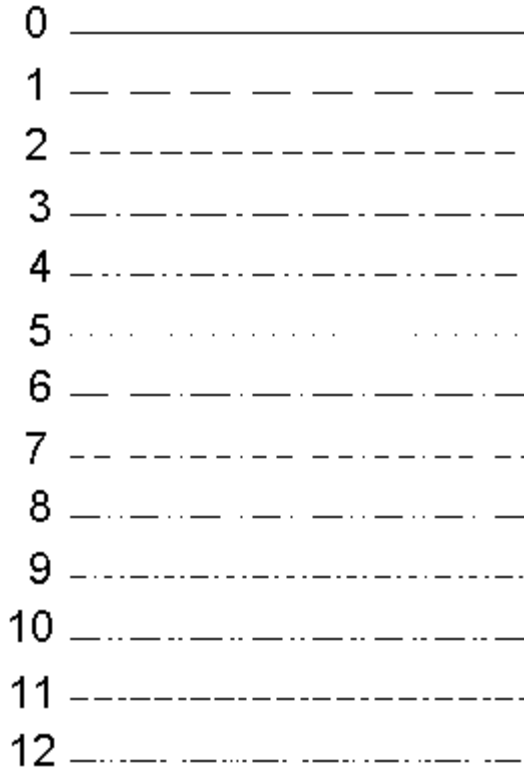

## Linetypes by the numbers

Example:

```
Dcad3.LineType = 1 'sets line type to dashed
```

## Material

Data Type: Integer

Description: sets the DesignCAD Material ID

Range: 0 to 22, higher if the user has defined custom materials.

0=Aluminum	12=Leaves
1=Army	13=Marble
2=Black	14=Oak
3=Brass	15=Pearl
4=Brick	16=Roof
5=Cherry	17=RoyalBlue
6=Chrome	18=Ruby
7=Cobalt	19=Steel

8=Concrete	20=Turq
9=CrystalBall	21=Walnut
10=General	22=White
11=Gold	

**Example:** Draw one sphere of each material type in a long row

```

Dim Params As Object
Dim dcpoint As Object
Set Params = Dcad3.AutoParameter
Set dcpoint = Dcad3.AutoPoint
Params.orientation = 2
Params.nLongitude = 10
Params.nLatitude = 10
Dim n As Integer
Dcad3.ShowWindow
Dcad3.SilentMode = True
Dcad3.BringToTop
For n = 0 To 22
Dcad3.Material = n
Dcad3.SetPoint (n - 11) * 4, 0, 0
Dcad3.SetPoint (n - 11) * 4, 1.75, 0
Dcad3.Sphere Params, False
Next

```

## MathematicalAngle

Data Type: Boolean

Description: Toggles angle format between Mathematical and Geographical

Example:

```
Dcad3.MathematicalAngle = True 'set mathematical angles
```

## MeasureUnit

Data Type: Integer

Description: Determines the units used to measure the paper size when printing.

```

1 = inches
0.0254= meters
2.54 =centimeters
25.4= millimeters
All other values default to inches.

```

Example:

```
Dcad3.MeasureUnit = 2.54 'set paper units to 'centimeters.
```

## MultipleLayer

Data Type: Boolean

Description: toggles the layer editing method between all entities, regardless of layer, and only entities on the current layer.

Example:

```
Dcad3.MultipleLayer = True
```

## **\*\*Name**

Data Type: String

Description: the name of the DesignCAD program file

Example:

```
Dim DcName as String
DcName = Dcad3.Name
```

## **nDimPrecision**

Data Type: Integer

Description: Sets the number of decimal digits of precision for dimensioned values

Example:

```
Dcad3.nDimPrecision = 3 'sets 3 decimal digits of 'accuracy,
                        i.e. "10.123"
```

## **nPolygonSide**

Data Type: Integer

Description: Determines the default number of sides for the polygon commands

Example:

```
Dcad3.nPolygonSide = 8
```

## **\*\*Path**

Data Type: String

Description: Returns the full path to the directory DesignCAD is in.

Example:

```
Dim DcPath as String
DcPath = Dcad3.Path
```

## **PointColor**

Data Type: Long

Description: sets the color used for marking points set during a drawing command.

Example:

```
Dcad3.PointColor = RGB(0, 0, 255)
```

## **PointType**

Data Type: Integer

Description: changes the shape of the points set in 2D Drafting Mode from a cross (+) to a dot(.). This property only affects 2D Drafting Mode.

Range: 1 to 2

```
1=cross-shaped points
2=dots for points
```

Example:

```
Dcad3.PointType=2
```

## **PrinterTopMargin**

## **PrinterBottomMargin**

## **PrinterLeftMargin**

## PrinterRightMargin

Data Type: Double

Description: Sets top margin for printer

Example:

```
Dcad3.MeasureUnit = 1 'set inches for paper units
Dcad3.PrinterTopMargin = 0.75
Dcad3.PrinterBottomMargin = 0.5
Dcad3.PrinterLeftMargin = 1
Dcad3.PrinterRightMargin = 1
```

## ProjectionMode

Data Type: Integer

Description: Sets projection method to Parallel or Perspective

Range: 0, 1

0=Perspective Projection  
1=Parallel Projection

Example:

```
Dcad3.ProjectionMode = 1 'set Parallel Projection
```

## ReturnValue

Data Type: Integer

Description: This returns the error status of the previous method. The value is reset at the start of execution for each method, and remains after the method returns until manually reset or another method is executed. (This can currently be treated as a Boolean, but it is actually implemented as an Integer type for future expansion)

Values:

0 = No Error Occurred  
-1 = Error Occurred

Example:

```
Dcad3.Fillet Params, False
If Dcad3.ReturnValue <> 0 Then MsgBox "An error occurred."
```

## RubberbandColor

Data Type: Long

Description: sets the color for the rubberband line

Example:

```
Dcad3.RubberbandColor = RGB(0, 255, 0)
```

## SaveParameter

Data Type: Boolean

Description: Determines whether or not certain drawing parameters are saved with the drawing file

Example:

```
Dcad3.SaveParameter = True
```

## ScaleMode

Data Type: Integer

Description: determines whether Merge or Symbol Load loads the drawing at original scale or at a changeable scale determined by the handle placement.

0=changeable scale  
1=original scale

Example:

```
Dcad3.ScaleMode=1 'merge files at original scale
```

### **SCursorStepSize**

Data Type: Single

Description: Small cursor step size (using Shift + Arrow keys)

Example:

```
Dcad3.ScursorStepSize = 0.5
```

### **ShowAttribute**

Data Type: Boolean

Description: Toggles visibility of Attribute entities. You must regenerate the screen after changing this value to update the display

Example:

```
Dcad3.ShowAttribute = True 'display attributes  
Dcad3.RegenerateAll 'show the results
```

### **ShowErrorMessage**

Data Type: Boolean

Description: Enables or disables the display of error messages from DesignCAD

Example:

```
Dcad3.Setpoint 0, 0, 0  
Dcad3.Setpoint 10, 0, 0  
Dcad3.Lines False  
Dcad3.Setpoint 10, 0, 0  
Dcad3.Setpoint 10, 10, 0  
Dcad3.Lines False  
Dcad3.ShowErrorMessage = True  
Dcad3.Setpoint -10, 0, 0  
Dcad3.Setpoint 60, 20, 0  
Dcad3.Fillet Params, False  
'error message "command failed" appears
```

### **ShowGrid**

Data Type: Boolean

Description: Toggles display grid off/on

Example:

```
Dcad3.ShowGrid = True 'turns on display grid
```

### **ShowSnapGrid**

Data Type: Boolean

Description: Toggles snap grid off/on

Example:

```
Dcad3.SnapGrid = False
```

### **SmoothSurface**

Data Type: Boolean

Description: turns on or off the "smooth shading" parameter of objects drawn subsequently.

Example:

```
Dcad3.SmoothSurface = False
'all items drawn after this will shade with a 'faceted
appearance.
```

## SnapGridSize

Data Type: Single

Description: Size of snap grid increments in drawing units

Example:

```
Dcad3.SnapGridSize = 0.25 'set snap grid to 1/4 unit
```

## Sound

Data Type: Integer

Description: Sets the beep style for DesignCAD

Range: 0-2

```
0=Off
1=Beep on points set
2=Beep on error only
```

Example:

```
Dcad3.Sound=1
```

## StaticDimension

Data Type: Boolean

Description: turns autodimensioning off/on

Example:

```
Dcad3.StaticDimension = True
'Dimensions will be stored as separate arrows, 'text, and lines.
The text values will not update 'if the drawing is rescaled.
```

## TextAngle

Data Type: Single

Description: Default text angle

Example:

```
Dcad3.TextAngle = 0 ' defaults text to 'horizontal angle
```

## TextSize

Data Type: Single

Description: Default text height

Example:

```
Dcad3.TextSize = 2.0
```

## ViewDistance

Data Type: Double

Description: Distance of the viewer from the drawing.

Example:

```
Dcad3.ViewDistance = 100 'sets a "close-up" view 'of the
drawing.
```

## **Visible**

Data Type: Boolean

Description: This makes the DesignCAD drawing screen visible or invisible.

**Note:** While a drawing command is in effect the drawing screen automatically becomes visible.

Example:

```
Dcad3.Visible = True
```

## **Xangle**

## **Yangle**

## **Zangle**

Data Type: Double

Description: Viewing angle rotations about each of the coordinate axes.

Example:

```
Dcad3.XAngle = 90
```

```
Dcad3.YAngle = 0
```

```
Dcad3.ZAngle = 0 'sets up a top view
```



In all the methods listed here, Params will represent some object that has been declared and initialized as an object of class AutoParameter, like so:

```
Dim Params as Object
Set Params = Dcad3.AutoParameter
'sets up an object to contain the parameters for 'the command
```

Some methods will also require an AutoEntity object, created like this:

```
Dim Entity as Object
Set Entity = Dcad3.AutoEntity
```

You can use any acceptable Visual Basic name as the name of the AutoParameter or AutoEntity object.

Many methods take the parameter ShowCmdLine. If set to True, the commandline for the corresponding DesignCAD command is visible, and the user may be able to change some of the parameters via the commandline. If ShowCmdLine is set to False, then the command line is not shown, and the user cannot modify the preset values.

Some methods will take the parameter KeepGettingPoints. When this is True, the program will wait for the user to enter any additional points necessary to complete the command. If it is False, the program will run the command with only the points set by the program.

Many of the methods listed here have an additional, preferred form. The preferred form is noted below the original form of the method (and its parameters where applicable). If both of the forms are demonstrated in the Example section of the method entry, one of the forms is commented out.

### **Command CmdName as String, AutoParameter as Object**

**Parameters:** vary with the individual command, see examples below...

incomplete: True or False

True = user can keep setting points (for line, curve, etc.)

False = use only points already set

showCmdLine: True or False

True = show command line (allows user to change settings)

False = no command line (user cannot change the settings for the command)

This parameter can be used when the user is required to set extra points and you want to allow him to also change the command options (such as text font, arrow style, number of facets, etc.) If your program sets the minimum number of points needed to execute the command, this parameter has little effect. Setting it to False may speed up your program slightly.

**Data Type:** Integer

---

**AngleBetween2Lines Params, ShowDig As Boolean**

Params.Angle - Single – The angle between the two lines

Description: Measures the angle between a pair of lines. The lines must lie in a common plane.

Example:

```
Dcad3.SetPoint 0, 0, 0
Dcad3.SetPoint 10, 0, 0
Dcad3.Lines False
Dcad3.SetPoint 0, 0, 0
Dcad3.SetPoint 0, 0, 10
Dcad3.Lines False
Dcad3.SetPoint 10, 0, 0
Dcad3.SetPoint 0, 0, 10
Dcad3.AngleBetween2Lines Params, False
MsgBox Params.angle
```

### Arc Params, ShowCmdLine as Boolean

Description: Draws an arc of specified span angle based on center and starting point.

Params.createAs - Integer ;

```
0=arc
1=line
```

Params.angle - Single

Example:

```
Params.angle = 120
Params.createAs = 0
Dcad3.Arc Params, False
```

### Arc2 Params, ShowCmdLine as Boolean

Description: Draws an arc of specified radius, based on beginning, end and center points.

Params.createAs - Integer ;

```
0=arc
1=line
```

Params.radius - Single

Example:

```
Params.radius = 10
Params.createAs = 0
Dcad3.Arc2 Params, True
```

### Arc3 Params, ShowCmdLine as Boolean

Description: Draws an arc which passes through three consecutive points.

Params.createAs - Integer ;

```
0=arc
1=line
```

Example:

```
Params.createAs = 0
Dcad3.Setpoint 5,0,0
```

```
Dcad3.Setpoint 10.25,5.25,0
Dcad3.Setpoint 0,4.75, 5.25
Dcad3.Arc3 Params, True
```

### **Arc4 Params, ShowCmdLine as Boolean**

Description: Draws an arc with center, starting, and ending points.

Params.createAs - Integer ;

```
0=arc
1=line
```

Example:

```
Params.createAs = 0
Dcad3.Setpoint 0,0,0
Dcad3.Setpoint 10,0,0
Dcad3.Setpoint 0,10,0
Dcad3.Arc4 Params, True
```

### **Arc5 Params, ShowCmdLine as Boolean**

Description: Draws an arc (of changeable radius) given start, end, and center points.

Params.createAs - Integer ;

```
0=arc
1=line
```

Example:

```
Params.createAs = 1 ' create a vectorized arc
Dcad3.Setpoint 0,0,0
Dcad3.Setpoint 10,10,0
Dcad3.Setpoint 10,0,0
Dcad3.Arc5 Params, False
```

### **Area**

Description: Returns the area enclosed by points set by the user (or by the program).

Data Type: Double

Example:

```
'set three points for a triangular area
Dcad3.Setpoint 0,0,0
Dcad3.Setpoint 10,0,0
Dcad3.Setpoint 10,10,0
Dcad3.Lines False
'set a point on the line and get its area
Dcad3.Setpoint 10,0,0
MsgBox "The area enclosed by the points is: " & Dcad3.Area
```

Example 2:

```
'Draw a line, select it, then determine its area
Dim Enty As Object
Dcad3.BringToTop
```

```

'Set points for a 10x10 box
Dcad3.Setpoint 0, 0, 0
Dcad3.Setpoint 10, 0, 0
Dcad3.Setpoint 10, 10, 0
Dcad3.Setpoint 0, 10, 0
Dcad3.Setpoint 0, 0, 0
'Draw the line
Dcad3.Lines False
'Set a point on the line, then select it.
Dcad3.Setpoint 10, 0, 0
Dcad3.Select2D 0
'get the id of the selected entity
Dim id As Integer
Dcad3.GetSelect id
'store the details of the selected entity
'in an AutoEntity object called Enty
Set Enty = Dcad3.AutoEntity(id)
'Set all the points and find the area
Dim i As Integer
For i = 0 To Enty.nPoints - 1
    Enty.Getpoint i, dcpoint
    Dcad3.Setpoint dcpoint.x, dcpoint.y, dcpoint.z
Next
MsgBox Dcad3.Area

```

## Arrangelcons

Description: organized the icons for minimized View windows

Example:

```
Dcad3.ArrangeIcons
```

## Array Params, ShowCmdLine as Boolean

Description: makes multiple copies in up to three directions

Params.nRepCopy1 - Integer

Params.nRepCopy2 - Integer

Params.nRepCopy3 - Integer

Example: make a 3x3x3 array of boxes, with gaps of one unit in x, 5 units in y, and 2.5 units in z

```

Dcad3.Setpoint 0, 0, 0
Dcad3.Setpoint 5, 5, 5
Dcad3.Box
Dcad3.Setpoint 0, 0, 0
Dcad3.Select2D 0
Dcad3.Setpoint 6, 0, 0
Dcad3.Setpoint 0, 10, 0
Dcad3.Setpoint 0, 0, 7.5

```

```

params.nrepcopy1 = 3
params.nrepcopy2 = 3
params.nrepcopy3 = 3
Dcad3.Array params, False

```

### Arrow Params, ShowCmdLine as Boolean, KeepGettingPts as Boolean

Description: Draws an arrow, with the last point representing the point.

Params.arrowSize - Single ; multiple of current text size

Params.arrowType - Integer ;

1=short  
2=slash  
3=filled circle  
4=filled short  
5=filled long  
6=none  
7=hollow circle  
8=hollow short  
9=hollow long  
10=wide  
11=filled wide  
12=hollow wide

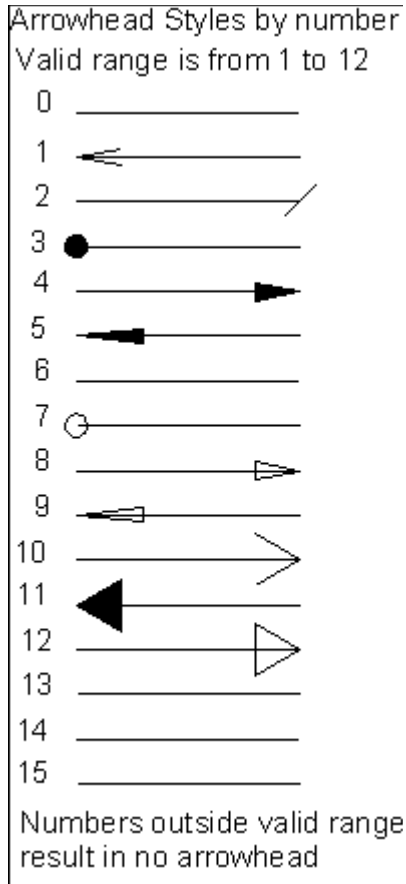

Example: Draw one of each type of arrow

```

'setup code
Dim Dcad3 as Object
Set Dcad3 = GetObject (, "designcad.Document")
Dim Params as Object
Set Params = Dcad3.AutoParameter
Dim dcpoint as Object
Set dcpoint = Dcad3.AutoPoint
'
'
'
'

```

```

    '
    .
    Dcad3.TextSize = 2.0
    Params.arrowSize = 1.0
    Dim n as Integer
    For n = 1 to 12
    Params.arrowType = n
    Dcad3.SetPoint 0.0, 24.0 - 2.0 * n, 0.0
    Dcad3.SetPoint 10.0, 24.0 - 2.0 * n, 0.0
    Dcad3.Arrow Params, False, False
    Next

```

### **Attribute Params, ShowCmdLine as Boolean**

Description: Draws an attribute

Params.textContent - String[80]

Params.textSize - Single

Example:

```

    Params.textContent = "2x4, weather-treated, 12 feet"
    Params.textSize = 1
    Dcad3.Attribute Params, True

```

### **Balloon Params, ShowCmdLine as Boolean**

Description: Draws a text balloon. If the text is too large at the default text size to fit inside the balloon, it is shrunk automatically to fit within the balloon.

Params.textContent - string[80]

Params.balloonSize - Single : represents balloon radius, not diameter.

Example:

```

    Params.textContent="Balloon size is 30"
    Params.balloonSize = 30.0
    Dcad3.Balloon Params, True

```

### **BezierCurve KeepGettingPts as Boolean**

Description: Draws a bezier curve.

Example:

```

    Dcad3.Setpoint 0,0,0
    Dcad3.Setpoint 0, 20,0
    Dcad3.Setpoint 20,0,0
    Dcad3.Setpoint 20,-20,0
    Dcad3.BezierCurve False

```

### **Box**

Description: Draws a 3D box.

Example: Draw a box 20 units high, with a 10x10 base.

```

    Dcad3.Setpoint 0,0,0
    Dcad3.Setpoint 10,20,10
    Dcad3.Box

```

## Box2D Params, ShowCmdLine as Boolean

Description - Draws a rectangular plane or vector.

Params.createAs -

0=plane

1=vector

Params.alignment - Integer

## BreakLine

Description: breaks a complex line into individual segments

Example:

```
Dcad3.Setpoint 0, 0, 0
Dcad3.Setpoint 10, 0, 0
Dcad3.Setpoint 20, 10, 0
Dcad3.Setpoint 25, 5, 0
Dcad3.Setpoint 20, 15, 0
Dcad3.Setpoint 10, 20, 0
Dcad3.Lines False
Dcad3.Setpoint 10, 20, 0
Dcad3.Select2D 0
Dcad3.BreakLine
Dcad3.Setpoint 10, 20, 0
Dcad3.Select2D 0
```

## BringToTop

Description: Brings DesignCAD to the top of all other windows

## Cascade

Description: Arranges all open document views in cascaded order

## Chamfer Params, ShowCmdLine as Boolean

Description: Trims a flat face onto the corner of two intersecting lines

Params.depth - Single

Params.originalLines - Boolean - if True, leaves original lines at corner

Example:

```
Dcad3.Setpoint 0, 0, 0
Dcad3.Setpoint 10, 0, 0
Dcad3.Lines False
Dcad3.Setpoint 5, 10, 0
Dcad3.Setpoint 5, 0, 0
Dcad3.Lines False
Dcad3.Setpoint 4, 0, 0
Dcad3.Setpoint 5, 1, 0
Params.depth = 2
Dcad3.Chamfer Params, False
```

### Circle1 Params, ShowCmdLine as Boolean

Description: Draws a circle based on a center point and any point on the circumference.

Params.createAs - Integer ;

0=circle  
1=line  
2=plane

Example: Draw a circular surface with radius 12, center on the origin, lying in the XZ plane

```
Params.createAs = 2  
Dcad3.Setpoint 0, 0, 0  
Dcad3.Setpoint 12, 0, 0  
Dcad3.Setpoint 0, 0, 1  
Dcad3.Circle1 Params, False
```

### Circle2 Params, ShowCmdLine as Boolean

Description: Draws a circle based on two points on the diameter

Params.createAs - Integer ;

0=circle  
1=line  
2=plane

Example:

```
Dcad3.Setpoint 0,0,0  
Dcad3.Setpoint 0,10,0  
Dcad3.Setpoint 0,0,1  
Params.createAs = 0  
Dcad3.Circle2 Params, False
```

### Circle3 Params, ShowCmdLine as Boolean

Description: Draws a circle passing through three points.

Params.createAs - Integer ;

0=circle  
1=line  
2=plane

Example:

```
Params.createAs = 1  
Dcad3.Setpoint 0,0,0  
Dcad3.Setpoint 0,10,0  
Dcad3.Setpoint 5,0,5  
Dcad3.Circle3 Params, False
```

### Circle4 Params, ShowCmdLine as Boolean

Description: Draws a circle of preset radius with a given centerpoint.

Params.createAs - Integer ;

0=circle  
1=line  
2=plane



Params.radius - Single ;

Example:

```
Params.createAs = 0
Params.radius = 5
Dcad3.Setpoint 0,0,0
Dcad3.Setpoint 10,10,10
Dcad3.Circle4 Params, True
```

### CircleTangent Params, ShowCmdLine as Boolean

Params.createAs - Integer ;

```
0=circle
1=line
2=plane
```

Params.radius - Single;

Example:

```
'Draw two lines
Dcad3.Setpoint 0,0,0
Dcad3.Setpoint 20,0,0
Dcad3.Lines False
Dcad3.Setpoint 10, -10,0
Dcad3.Setpoint 10, 10,0
Dcad3.Lines False
'draw three circles tangent to the lines
Dcad3.Setpoint 0,0,0
Dcad3.Setpoint 10,10,0
Params.createAs = 0
Params.radius = 5
Dcad3.CircleTangent Params, True
Dcad3.Setpoint 20,0,0
Dcad3.Setpoint 10,10,0
Params.createAs = 1
Dcad3.CircleTangent Params, True
Dcad3.Setpoint 0,0,0
Dcad3.Setpoint 10, -10,0
Params.createAs = 2
Dcad3.CircleTangent Params, True
```

### CircularArray Params, ShowCmdLine as Boolean

Description: Makes multiple copies of the selected object(s) in a circular or helical array

Params.nCopy - Integer

Params.angle - Single

Params.offset - Single

Params.axis - Integer ;

```
0=x,
1=y,
```

2=z,  
3=2-point,  
4=line

Example: make 60 copies of a sphere in a spiral array

```
Dcad3.Setpoint 24, 0, 0  
Dcad3.Setpoint 25, 0, 0  
Dcad3.sphere params, False  
Dcad3.Setpoint 24, 0, 0  
Dcad3.Select2D 0  
Dcad3.Setpoint 0, 0, 0  
params.ncopy = 60  
params.offset = 15  
params.angle = -900  
params.axis = 1  
Dcad3.CircularArray params, False
```

### **ClearSelection**

Description: De-selects all selected objects

### **Close saveChanges As Boolean, fileName As String**

Description: closes the active drawing document.

SaveChanges - True – saves the drawing

False – doesn't save the drawing

fileName - String[250] – empty string "" uses the current filename. If the drawing is untitled, the SaveAs dialog box will appear

Example:

```
Dcad3.Close True, "e:\LostOnes\ThisFile.DC"
```

### **CombineLines**

Description: combines selected lines, curves, and arcs into a single continuous line.

Example:

```
Dcad3.Setpoint 0, 0, 0  
Dcad3.Setpoint 10, 0, 0  
Dcad3.Lines False  
Dcad3.Setpoint 10, 0, 0  
Dcad3.Setpoint 5, 5, 0  
Dcad3.Lines False  
Dcad3.Setpoint 5, 5, 0  
Dcad3.Setpoint 0, 0, 0  
Dcad3.Lines False  
Dcad3.SelectAll  
Dcad3.CombineLines
```

### **Cone Params, ShowCmdLine as Boolean**

Description: Draws a cone

**Params.orientation - Integer ;**

0=point on vertex  
1=midpoint of edge

**Params.nFacet - Integer ; [3 to 198]**

Example: Draw a pyramid, setting the first point in the center and the second on the midpoint of a side.

```
Dcad3.Setpoint 10, 0, 0
Dcad3.Setpoint 20, 0, 0
Dcad3.Setpoint 20, 20, 0
Params.orientation = 1
Params.nFacet = 4
Dcad3.Cone Params, False
```

## **Copy**

Description: Copies the selected item(s) to the clipboard, leaving the original in place

Example: see Cut

## **CopyImage**

Description: Copies a bitmap image of the selected portion of the drawing area to the clipboard.

Example:

```
Dcad3.Setpoint 0,0,0
Dcad3.Setpoint 10,0,0
Dcad3.Setpoint 10,20,-5
Dcad3.Cylinder Params, False
Dcad3.Setpoint -20, -20, -20
Dcad3.Setpoint 20,30,20
Dcad3.CopyImage
```

## **Crosshair**

Description: toggles DesignCad into or out of Crosshair mode

Example:

```
Dcad3.Crosshair
```

## **CursorStepSize**

Description: Opens the Cursor Options Folder

Example:

```
Dcad3.CursorStepSize
```

## **Curve Params, ShowCmdLine as Boolean, KeepGettingPts As Boolean**

Description: Draws a spline curve.

**Params.createAs - Integer ;**

0=curve  
1=line

Example:

```
Params.createAs = 0
Dcad3.Setpoint 10,10,0
Dcad3.Setpoint 20,20,0
Dcad3.Setpoint 30,10,0
Dcad3.Curve Params, False, False
```

## CurveToLine

Description: converts a selected spline curve to a line which passes through the same control points

Example:

```
Dcad3.Setpoint 0, 0, 0
Dcad3.Setpoint 10, 0, 0
Dcad3.Setpoint 20, 10, 0
Dcad3.Setpoint 25, 5, 0
Dcad3.Setpoint 20, 15, 0
Dcad3.Setpoint 10, 20, 0
Dcad3.Curve Params, False, False
MsgBox ""
Dcad3.Setpoint 10, 20, 0
Dcad3.Select2D 0
Dcad3.CurveToLine
MsgBox ""
Dcad3.LineToCurve
```

## CustomColor

Description: allows user to manually edit the current drawing color

Example:

```
Dcad3.CustomColor
```

## Cut

Description: cuts the selected item(s) to the clipboard

Example:

```
Dcad3.Setpoint 0, 0, 0
Dcad3.Setpoint 0, 10, 0
Dcad3.Setpoint 10, 10, 0
Dcad3.Setpoint 10, 0, 0
Dcad3.Setpoint 0, 0, 0
Dcad3.Lines False
Dcad3.Setpoint 0, 0, 0
Dcad3.Select2D 0
Dcad3.Copy
Dcad3.Setpoint 10, 0, 0
Dcad3.Paste
Dcad3.Cut
```

```
Dcad3.Setpoint 20, 0, 0
Dcad3.Paste
```

### **Cylinder Params, ShowCmdLine as Boolean**

Description: Draws a cylinder.

Params.orientation - Integer ;

0=point on vertex  
1=midpoint of edge

Params.nFacet - Integer ; number of sides

Example:

```
Dcad3.Setpoint 0, 0, 0
Dcad3.Setpoint 5, 0, 0
Dcad3.Setpoint 5,15,0
Params.orientation = 0
Params.nFacet = 12
Dcad3.Cylinder Params, False
```

### **DesignCADTile**

Description: Tiles the drawing area into a large perspective view, and smaller Front, Top, and Side views.

Example:

```
Dcad3.DesignCADTile
```

### **Dimension Params, ShowCmdLine as Boolean**

Description: Draws a linear dimension

Params.axis - Integer ;

0=x  
1=y  
2=z  
3=auto  
4=free

Params.orientation - Integer ;

0=normal  
1=perpendicular  
2=horizontal  
3=vertical

Params.precision - Integer ; -7 to +15 digits after decimal

Params.dimFormat - Integer ;

0=decimal units  
1=fractional units  
2=feet and decimal inches  
3=feet and fractional inches

Params.gapSize - Single

Params.overSize - Single

Params.textLocation - Integer ;

0=centered  
1=centered above arrows  
2=centered below arrows

3=right of arrows  
4=right, above  
5=right, below  
6=left of arrows  
7=left, above  
8=left, below

**Params.CreateAs - Integer ;**

0=dimension  
1=exploded dimension

**Example:**

```
Params.createAs = 0  
Params.dimFormat = 3  
Params.precision = 3  
Params.axis = 4  
Dcad3.Dimension Params, True
```

## **Dimension2 Params, ShowCmdLine as Boolean**

**Params.axis - Integer ;**

0=x,  
1=y,  
2=z,  
3=auto,  
4=free

**Params.CreateAs - Integer ;**

0=dimension,  
1=exploded dimension

**Params.orientation - Integer ;**

0=normal,  
1=perpendicular  
2=horizontal,  
3=vertical

**Params.precision - Integer ; -7 to +15 digits after decimal**

**Params.dimFormat - Integer ;**

0=decimal units  
1=fractional units  
2=feet and decimal inches  
3=feet and fractional inches

**Params.gapSize - Single**

**Params.overSize - Single**

**Params.textLocation - Integer ;**

0=centered  
1=centered above arrows  
2=centered below arrows  
3=right of arrows  
4=right, above  
5=right, below  
6=left of arrows  
7=left, above

8=left, below

## **DimensionAngle Params, ShowCmdLine as Boolean**

Description: Dimensions an angle

Params.orientation - Integer ;

0=normal

1=horizontal

Params.precision - Integer ; 0 to 15 digits after decimal

Params.dimFormat - Integer ;

0=decimal degrees

1=grads

2=radians

3=degrees-minutes-seconds

Params.gapSize - Single

Params.overSize - Single

Params.textLocation - Integer ;

0=above

1=below

Params.CreateAs - Integer ;

0=dimension

1=exploded dimension

Example:

```
Params.orientation = 0
Params.precision = 3
Params.dimFormat = 0
Dcad3.DimensionAngle Params, True
```

## **DimensionArc Params, ShowCmdLine as Boolean**

Params.orientation - Integer ;

0=normal,

1=horizontal

Params.precision - Integer ; -7 to 15 digits after decimal

Params.dimFormat - Integer ;

0=decimal units

1=fractional units

2=feet+decimal inches

3=feet+fractional inches

Params.gapSize - Single

Params.overSize - Single

Params.textLocation - Integer ;

0=above

1=below

Params.CreateAs - Integer ;

0=dimension

1=exploded dimension

## **DimensionBase Params, ShowCmdLine as Boolean**

Params.axis - Integer ;

0=horizontal  
1=vertical

Params.orientation - Integer ;

0=normal  
1=perpendicular  
2=horizontal  
3=vertical

Params.precision - Integer ; -7 to +15

Params.dimFormat - Integer ;

0=decimal  
1=fractional  
2=feet and decimal inches  
4=feet and fractional inches

Params.gapSize - Single

Params.overSize - Single

Params.offset - Single

Params.textLocation - Integer ;

0=centered  
1=centered above arrows  
2=centered below arrows  
3=right of arrows  
4=right, above  
5=right, below  
6=left of arrows  
7=left, above  
8=left, below

Params.CreateAs - Integer ;

0=dimension  
1=exploded dimension

## **DimensionChamfer Params, ShowCmdLine as Boolean**

Params.orientation - Integer ;

0=normal  
1=perpendicular  
2=horizontal  
3=vertical

Params.precision - Integer ; -7 to 15

Params.dimFormat - Integer ;

0=decimal units  
1=fractional units  
2=feet+decimal inches  
3=feet+fractional inches

Params.gapSize - Single

Params.overSize - Single

Params.textLocation - Integer ;

0=centered  
1=above  
2=below

Params.CreateAs - Integer ;



0=dimension  
1=exploded dimension

### **DimensionCoordinate Params, ShowCmdLine as Boolean**

Params.orientation - Integer ;

0=normal  
1=perpendicular  
2=horizontal  
3=vertical

Params.precision - Integer; -7 to +15

Params.dimFormat - Integer ;

0=decimal  
1=fractional  
2=feet and decimal inches  
4=feet and fractional inches

Params.gapSize - Single

Params.overSize - Single

Params.CreateAs - Integer ;

0=dimension  
1=exploded dimension

### **DimensionDiameter Params, ShowCmdLine as Boolean**

Params.axis - Integer ;

0=arrows and text inside  
1=arrows and text outside, line through diameter  
2=pullout style text and arrow  
3=arrows inside, text outside

Params.orientation - Integer ;

0=normal  
1=perpendicular  
2=horizontal  
3=vertical

Params.precision - Integer ; -7 to 15

Params.dimFormat - Integer ;

0=decimal  
1=fractional  
2=feet and decimal inches  
4=feet and fractional inches

Params.gapSize - Single

Params.overSize - Single

Params.textLocation - Integer ;

0=centered  
1=above  
2=below

Params.CreateAs - Integer ;

0=dimension  
1=exploded dimension

### **DimensionExtend Params, ShowCmdLine as Boolean**

Params.axis - Integer ;

0=horizontal  
1=vertical

Params.CreateAs - Integer ;

0=dimension  
1=exploded dimension

Params.orientation - Integer ;

0=normal  
1=perpendicular  
2=horizontal  
3=vertical

Params.precision - Integer ; -7 to +15 digits after decimal

Params.dimFormat - Integer ;

0=decimal  
1=fractional  
2=feet and decimal inches  
4=feet and fractional inches

Params.gapSize - Single

Params.overSize - Single

Params.textLocation - Integer ;

0=centered  
1=centered above arrows  
2=centered below arrows  
3=right of arrows  
4=right, above  
5=right, below  
6=left of arrows  
7=left, above  
8=left, below

### **DimensionProgress Params, ShowCmdLine as Boolean**

Params.axis - Integer ;

0=horizontal  
1=vertical

Params.CreateAs - Integer ;

0=dimension,  
1=exploded dimension

Params.orientation - Integer ;

0=normal,  
1=horizontal

Params.precision - Integer

Params.dimFormat - Integer

Params.gapSize - Single

Params.overSize - Single

Params.textLocation - Integer ;

0=above,  
1=below

### **DimensionRadius Params, ShowCmdLine as Boolean**

**Params.axis - Integer ;**

- 0=arrows and text inside
- 1=arrows inside, text outside
- 2=pullout style text and arrow
- 3=pullout + arrows inside

**Params.orientation - Integer ;**

- 0=normal
- 1=perpendicular
- 2=horizontal
- 3=vertical

**Params.precision - Integer ; -7 to 15**

**Params.dimFormat - Integer ;**

- 0=decimal
- 1=fractional
- 2=feet and decimal inches
- 4=feet and fractional inches

**Params.gapSize - Single**

**Params.overSize - Single**

**Params.textLocation - Integer ;**

- 0=centered
- 1=above
- 2=below

**Params.CreateAs - Integer ;**

- 0=dimension
- 1=exploded dimension

## **DimensionRadiusProgress Params, ShowCmdLine as Boolean**

**Params.CreateAs - Integer ;**

- 0=dimension,
- 1=exploded dimension

**Params.orientation - Integer ;**

- 0=normal,
- 1=horizontal,

**Params.precision - Integer ; -7 to 15**

**Params.dimFormat - Integer ;**

- 0=decimal
- 1=fractional
- 2=feet and decimal inches
- 4=feet and fractional inches

**Params.gapSize - Single**

**Params.overSize - Single**

## **DisableMenu**

Description: Grays out the DesignCAD menu so the user cannot access commands using the mouse or keyboard.

Example:

```
Dcad3.DisableMenu
```

## DisplayGrid

Description: toggles the Display Grid on or off

Example:

```
Dcad3.DisplayGrid
```

## DraftingMode2D

Description: Toggles 2D Drafting Mode on or off.

Example:

```
Dcad3.DraftingMode2D
```

## Drill

Description: Subtracts a Solid from one or more selected objects. These need not be solids themselves.

Example:

```
Dcad3.Setpoint 10,10,0
Dcad3.Setpoint 30,10,0
Dcad3.Setpoint 30,30,0
Dcad3.Setpoint 10,30,0
Dcad3.Plane
Dcad3.Setpoint 10,10,10
Dcad3.Setpoint 30,10,10
Dcad3.Setpoint 30,30,10
Dcad3.Setpoint 10,30,10
Dcad3.Plane
Dcad3.Setpoint 20,20,5
Dcad3.Setpoint 20,20,15
Dcad3.Sphere Params, True
Dcad3.Setpoint 10,10,0
Dcad3.Select3D 0
Dcad3.Setpoint 30,30,10
Dcad3.Select3D 1
Dcad3.Setpoint 20,20,15
Dcad3.Drill
```

## Duplicate

Description: make another copy of the selected object(s)

Example:

```
Dcad3.Setpoint 0, 0, 0
Dcad3.Setpoint 10, 10, 10
Dcad3.Box
Dcad3.Setpoint 0, 0, 0
Dcad3.select2d 0
Dcad3.Setpoint 0, 0, 0
Dcad3.Setpoint 15, 15, 0
```

```
Dcad3.Duplicate
```

### **Ellipse Params, ShowCmdLine as Boolean**

Description: draws an ellipse

Params.createAs - Integer ;

```
0=ellipse  
1=line  
2=plane
```

Example:

```
Params.createAs = 2  
Dcad3.Setpoint 10,10,0 ' set center point  
Dcad3.Setpoint 30,10,0 ' set end of 1st axis  
Dcad3.Setpoint 10,20,0 ' set end of 2nd axis  
Dcad3.Ellipse Params, False
```

### **EllipticalArc Params, ShowCmdLine as Boolean**

Description: Draw an elliptical arc based on center, starting, and ending points.

Params.createAs - Integer ;

```
0=arc  
1=line
```

Example:

```
Dcad3.Setpoint 0,0,0  
Dcad3.Setpoint 10,0,0  
Dcad3.Setpoint 0,5,0  
Params.createAs = 1  
Dcad3.EllipticalArc Params, True
```

### **EnableMenu**

Description: Returns the DesignCAD menu to an active state, so the user can access commands using the mouse or keyboard.

Example:

```
Dcad3.EnableMenu
```

### **EntitySelect**

Description: Allows the user to select all entities of a specific type

Example:

```
Dcad3.EntitySelect
```

### **Erase**

Description: Erases the selected entities

Example: have the user select some objects, then erase them

```
Dcad3.Select2D 0  
Dcad3.Erase
```

### **EraseLast**

Description: Erases the last item drawn.

Example: Draw three lines, then erase the last one.

```
Dcad3.Setpoint 0,0,0
Dcad3.Setpoint 10,0,0
Dcad3.Lines False
Dcad3.Color 255,0,0
Dcad3.Setpoint 0,10,0
Dcad3.Setpoint 10,10,0
Dcad3.Lines False
Dcad3.Color 0,0,255
Dcad3.Setpoint 0,20,0
Dcad3.Setpoint 10,20,0
Dcad3.Lines False
MsgBox "About to erase the blue line"
Dcad3.EraseLast
```

## Explode

Description: breaks a complex object (such as a dimension or a grid) into its component pieces. For example, a dimension will be converted to separate lines, arrows, and text.

Example:

```
Dcad3.Setpoint 0, 0, 0
Dcad3.Setpoint 20, 0, 0
Dcad3.Setpoint 20, 10, 0
Dcad3.Dimension Params, False
Dcad3.Setpoint 0, 0, 0
Dcad3.Select2D 0
Dcad3.Explode
Dcad3.ClearSelection
Dcad3.Setpoint 0, 10, 0
Dcad3.Select2D 0
```

## ExportDXF Params, ShowCmdLine as Boolean

Params.fileName - String[250]

## ExportIGES Params, ShowCmdLine as Boolean

Params.fileName - String[250]

## ExportRIB Params, ShowCmdLine as Boolean

Params.fileName - String[250]

## ExportWMF Params, ShowCmdLine as Boolean

Params.fileName - String[250]

## ExportWPG Params, ShowCmdLine as Boolean

Params.fileName - String[250]

### **Extend Params, ShowCmdLine as Boolean**

Param.selectOnly - Boolean ; if True, only selected object will be extended

### **ExtrudeFixed Scale as Single, ShowCmdLine as Boolean**

Description: Extrude the selected object(s) along a path with a specified ending scale

Example:

```
Dcad3.Setpoint 10, 0, 0
Dcad3.Setpoint 10, 2, 0
Dcad3.Circle1 Params, False
Dcad3.Setpoint 10, 0, 0
Dcad3.Select2D 0
Dcad3.Setpoint 10, 0, 0
Dcad3.Setpoint 10, 0, 10
Dcad3.Setpoint 10, 0, 20
Dim Escale as Single
Escale = 2.5
Dcad3.ExtrudeFixed Escale, False
```

### **ExtrudeVaried Factors() as Double, ShowCmdLine as Boolean**

Description: Extrude selected object(s) at varying scales, specifying the scale factor at each point

**Note:** The first point is always at a scale of 1.0, so if you set n points, you need an array of n-1 scale factors.

---

Example:

```
Dcad3.Setpoint 10, 0, 0
Dcad3.Setpoint 10, 2, 0
Dcad3.Circle1 Params, False
Dcad3.Setpoint 10, 0, 0
Dcad3.Select2D 0
Dcad3.Setpoint 10, 0, 0
Dcad3.Setpoint 10, 0, 10
Dcad3.Setpoint 10, 0, 20
Dim Factors(2) as Double
'note: array subscripts start at zero by default
Factors(0) = 2#
Factors(1) = 1#
Dcad3.ExtrudeVaried Factors, False
```

### **Fillet Params, ShowCmdLine as Boolean**

Description: Rounds the corner of two intersecting lines

Params.radius - Single

Params.originalLines - Boolean - if True, leaves original lines at corner

Example:

```
Dcad3.Setpoint 0, 0, 0
Dcad3.Setpoint 10, 0, 0
Dcad3.Lines False
Dcad3.Setpoint 5, 10, 0
Dcad3.Setpoint 5, 0, 0
Dcad3.Lines False
Dcad3.Setpoint 4, 0, 0
Dcad3.Setpoint 5, 1, 0
Params.radius = 2
Dcad3.Fillet Params, False
```

### **FilletCorner Params, ShowCmdLine as Boolean**

Description: rounds the corner of a solid

Params.radius - Single

Params.nFacet - Integer

Example:

```
Dcad3.Setpoint 0, 0, 0
Dcad3.Setpoint 10, 10, 10
Dcad3.Box
Dcad3.Setpoint 10, 10, 0
Params.radius = 5
Params.nFacet = 20
Dcad3.FilletCorner Params, False
```

### **FilletEdge Params, ShowCmdLine as Boolean**

Description: rounds an edge of a solid

Params.radius1 - Single

Params.radius2 - Single

Params.nFacet - Integer

Example:

```
Dcad3.Setpoint 0, 0, 0
Dcad3.Setpoint 10, 10, 10
Dcad3.Box
Dcad3.Setpoint 10, 5, 0
Params.radius1 = 5
Params.radius2 = 6
Params.nFacet = 20
Dcad3.FilletEdge Params, False
```

### **FitToAllWindows**

Description: Zoom the drawing in such a way that it fills each view window as completely as possible.

Example:

```
Dcad3.FitToAllWindows
```



## **FitToWindow**

Description: Zoom the drawing so that it just fits within the active view window

Example:

```
Dcad3.FitToWindow
```

## **FrontView**

Description: Switch the current view angles so as to provide a Front View

Example:

```
Dcad3.FrontView
```

## **GetCenterOfGravity dcpoint as Object**

Data Type: Boolean

Description: returns the center of gravity of an object which has just had a point set on it.

Example:

```
Dim dcpoint as Object
Set dcpoint = Dcad3.AutoPoint
Dcad3.Setpoint 10,10,0
Dcad3.Setpoint 20,10,0
Dcad3.Circle1 Params, False
Dcad3.Setpoint 10,20,0
Dcad3.GetCenterOfGravity dcpoint
MsgBox dcpoint.x & ", " & dcpoint.y & ", " & dcpoint.z
```

## **GetEntityCount -- Read\_Only**

Data Type: Long

Description: number of entities in the drawing

Example:

```
NumEnt = Dcad3.GetEntityCount
```

## **GetMaterialCount**

Data Type: Integer

Description: returns the number of available materials currently recognized by DesignCAD.

Example:

```
MsgBox Dcad3.GetMaterialCount & " materials available now"
```

## **GetMaxX -- Read\_Only**

## **GetMaxY -- Read\_Only**

## **GetMaxZ -- Read\_Only**

## **GetMinX -- Read\_Only**

## **GetMinY -- Read\_Only**

## **GetMinZ -- Read\_Only**

Data Type: Double

Description: these functions return the corners of the bounding box for the entire drawing.

## **GetNearestSegment snapPoint as AutoPoint, startPoint as AutoPoint, endPoint as AutoPoint)**

Description: returns the endpoints of the nearest segment of the nearest line entity. snapPoint is preset by the user, and the endpoints of the segment are returned in startPoint and endPoint.

Example:

```
Dim snapPoint as Dcad3.AutoPoint
Dim startPoint as Dcad3.AutoPoint
Dim endPoint as Dcad3.AutoPoint
Dcad3.SetPoint 0, 0, 0
Dcad3.SetPoint 10, 0, 0
Dcad3.SetPoint 10, 10, 0
Dcad3.SetPoint 0, 10, 0
Dcad3.Lines False
snapPoint.x = 12
snapPoint.y = 5
snapPoint.z = 0
GetNearestSegment snapPoint, startPoint, endPoint
msgbox " the first point: " & startPoint.x & ", " & startPoint.y & ", " & startPoint.z
'the startpoint should be at coordinate 10, 0, 0
msgbox " the second point: " & endPoint.x & ", " & endPoint.y & ", " & endPoint.z
'the endpoint should be at coordinate 10, 10, 0
```

### **GetPoint dcpoint as AutoPoint**

Description: Retrieves the XYZ values of a point set by the user.

Example:

```
Dim dcpoint as Object
set dcpoint = Dcad3.AutoPoint
MsgBox "Set one point for the center of the cone"
Dcad3.GetPoint
Dcad3.Setpoint dcpoint.x, dcpoint.y, dcpoint.z
Dcad3.Setpoint dcpoint.x + 10, dcpoint.y, dcpoint.z
Dcad3.Setpoint dcpoint.x+10, dcpoint.y+20, dcpoint.z
Dcad3.Cone Params, False
```

### **GetPointSetNum -- Read\_Only**

Data Type: Integer

Description: returns the number of points the user has set.

Example:

```
NumPts = Dcad3.GetPointSetNum
```

### **GetReleaseDate Params**

Description: Places the release date and time of DesignCAD into the appropriate parameter fields. These values are read\_only.

Params.date - String

Params.time - String

Example:

```
Dcad3.GetReleaseDate Params
MsgBox "DesignCAD Release Date is: " & Params.Date & Chr$(13) &
"DesignCAD Release Time is: " & Params.Time
```

### **GetSelect i as Long**

Data Type: Long

Description: Returns the entity ID of the selected entity indexed by i

Example:

```
Dcad3.SelectAll
Dim n As Long
n = Dcad3.GetSelectedEntitiesNo
Dim i As Long
Dim id as Long
MsgBox "No. of entities selected: " & n - 1
For i = 0 To n - 1
id = Dcad3.GetSelect(i)
    Set Enty = Dcad3.AutoEntity(id)
    MsgBox "Entity " & Enty.ID & " is type " & _
    Enty.entityType & " having " & Enty.nPoints & " _ points."
Next
```

### **GetSelectedEntitiesNo - Read\_Only**

Data Type: Long

Description: returns the number of selected entities

Example:

```
NumSelected = Dcad3.GetSelectedEntitiesNo
```

### **GetUserInfo Params**

Description: Places the registered user's name, company, and serial number into the appropriate parameter fields. These values are read\_only.

Params.userName - String

Params.companyName - String

Params.serialNo - String

Example:

```
GetUserInfo Params
MsgBox "Registered to: " & Params.userName
MsgBox "Company: " & Params.companyName
MsgBox "Serial Number: " & Params.serialNo
```

### **GravitySnap snapPoint as AutoPoint, setThePoint as Boolean**

Description: moves the cursor from the coordinate given in snapPoint to the nearest existing point in the drawing, and optionally sets a point there. The information in snapPoint is automatically updated to show the new cursor location.

Example: Draw a box, then draw a diagonal line from corner to corner.

```

Dim snapPoint as Dcad3.AutoPoint
Dcad3.SetPoint -10, -10, -10
Dcad3.SetPoint 10, 10, 10
Dcad3.Box
snapPoint.x = -12
snapPoint.y = 12
snapPoint.z = -12
Dcad3.GravitySnap SnapPoint, True
snapPoint.x = 12
snapPoint.y = -12
snapPoint.z = 12
Dcad3.GravitySnap SnapPoint, True
Dcad3.Lines False

```

## GroupDefine

Description: Combines all selected entities into a group.

Example:

```

Dcad3.Setpoint 0,0,0
Dcad3.Setpoint 5,5,5
Dcad3.Box
Dcad3.Setpoint 10,0,0
Dcad3.Setpoint 15, 5, 5
Dcad3.Box
Dcad3.Setpoint 5,5,0
Dcad3.Setpoint 10,10,5
Dcad3.Box
Dcad3.Setpoint 0,0,0
Dcad3.Setpoint 15, 10,5
Dcad3.Select3D 0
Dcad3.GroupDefine

```

## GroupExplode

Description: explode the currently selected group(s) into its component entities

Example:

```

Dcad3.GroupExplode

```

## Hammer Params, ShowCmdLine as Boolean

Description: deforms a mesh as if it were struck with a hammer

Params.hammerType - Integer ;

```

0=rounded,
1=sharp

```

Params.radius - Single

Params.hammerFreeEdge - Boolean

Example:

```

Params.nSegment = 10
Dcad3.Setpoint 0, 0, 0
Dcad3.Setpoint 20, 0, 0
Dcad3.Lines False
Dcad3.Setpoint 0, 20, 0
Dcad3.Setpoint 20, 20, 0
Dcad3.Lines False
Dcad3.Setpoint 0, 0, 0
Dcad3.Setpoint 0, 20, 0
Params.ConnectType = 0
Params.nSurface = 20
Params.nBreak = 20
Params.radius = 10
Dcad3.SurfaceConnect Params, False
Dcad3.Setpoint 10, 10, 0
Dcad3.Setpoint 10, 10, 10
Dcad3.Hammer Params, False

```

### **Hemisphere Params, ShowCmdLine as Boolean**

Description: Draws a hemisphere

Params.orientation - Integer ;

0=vertex point

1=midpoint of edge

2=point on pole

Params.nLongitude - Integer ; number of facets from pole to equator

Params.nLatitude - Integer ; number of facets around equator

Example:

```

Dcad3.Setpoint 10,10,0
Dcad3.Setpoint 10,0,0
Dcad3.Setpoint 10,0,-10
Params.orientation = 1
Params.nLongitude = 15
Params.nLatitude = 10
Dcad3.Hemisphere Params, False

```

### **Hide**

Description: Makes DesignCAD invisible

Example:

```
Dcad3.Hide
```

### **HideLines Params, ShowDialog as Boolean**

**Note:** If two points are preset, only that area will be "hidden". Otherwise the entire drawing window will be "hidden". If ShowDialog is True, then the user can choose to hide an entire region or only a portion of it.

---

Params.showDimension - boolean – Show Dimensions after hiding lines?  
Params.showLines - boolean – Show line and curve entities after hiding lines?  
Params.showText - boolean – Show text after hiding lines?  
Description: Hidden line removal for 3D objects

Example:

```
Params.showDimension = False  
Params.showLines = True  
Params.showText = False  
Dcad3.HideLines Params, False
```

### **ImportDXF Params, ShowCmdLine as Boolean**

Params.fileName - String[250]

Description: Use to import a DXF drawing into the current document

Example:

```
Params.fileName = "C:\ACAD12\DXF\HOUSE.DXF"  
Dcad3.ImportDXF Params, False
```

### **ImportHPGL Params, ShowCmdLine as Boolean**

Params.fileName - String[250]

Description: Import an HPGL file into the current document

Example:

```
Params.fileName = "C:\PLOTFILE\A41696.HGL"  
Dcad3.ImportHPGL Params, False
```

### **ImportIGES Params, ShowCmdLine as Boolean**

Params.fileName - String[250]

Description: Import an IGES file into the current document

Example: Let the user choose which IGES file to import

```
Params.fileName = ""  
Dcad3.ImportIGES Params, True  
'since ShowCmdLine is True, the ImportIGES dialog 'box appears,  
and the user can browse for the 'file he wants
```

### **ImportWMF Params, ShowCmdLine as Boolean**

Params.fileName - String[250]

Description: Import a Windows Metafile into the current document

Example:

```
Params.fileName = "C:\DCAD\MyFile.WMF"  
Dcad3.ImportWMF Params, False
```

### **ImportXYZ Params, ShowCmdLine as Boolean**

Params.fileName - String[250]

Params.createAs - Integer

- 0 - Show Import Options dialog box
- 1 - Connect points with a line
- 2 - Connect points with a curve
- 3 - Mark points with a small box
- 4 - Mark points with a small circle

## Params.pointSize - Single

**Note:** If either pointSize or createAs parameters are omitted, the Import Options dialog box is displayed with a default point size of 0.5 and connect with line preset..

---

### ShowCmdLine - Boolean

False - use filename parameter

True - Show Open File dialog box even if filename parameter specified

Description: Import a file containing XYZ coordinates into DesignCAD

Example:

```
Params.fileName = "d:\dc3win95\test.xyz"  
Params.CreateAs = 2  
Params.pointSize = 0.25  
Dcad3.ImportXYZ Params, False
```

### InfoBox

Description: toggles the visibility of the Info Box.

Example:

```
Dcad3.InfoBox
```

### InitializeDCAD iniFile as String

Description: Use this command to properly initialize DesignCAD after opening the program using CreateObject ("designcad.Document"). This command is not necessary if GetObject was used to make DesignCAD available to Visual Basic. You should use an empty string "" for the iniFile variable

Example:

```
Dim Dcad3 as Object  
Set Dcad3 = CreateObject ("designcad.Document")  
Dcad3.InitializeDCAD ""
```

### InterferenceCheck

Description: Determines whether two solids have any overlapping volume.

Example:

```
Dcad3.Setpoint 10, 10, 10  
Dcad3.Setpoint 10, 10, 20  
Dcad3.Sphere Params, True  
Dcad3.Setpoint 15, 10, 10  
Dcad3.Setpoint 0, 0, 0  
Dcad3.Box  
Dcad3.Setpoint 0, 0, 0  
Dcad3.Setpoint 10, 10, 20  
Dcad3.InterferenceCheck
```

### Intersect1Snap snapPoint as AutoPoint, setThePoint as Boolean

Description: given a starting location in snapPoint, this method moves the cursor to the

nearest intersection and optionally sets a point there. The data in snapPoint is changed to the actual coordinate for the intersection point.

Example:

```
Dcad3.Setpoint 0, 10, 0
Dcad3.Setpoint 20, 10, 0
Dcad3.Lines False
Dcad3.Setpoint 10, 0, 0
Dcad3.Setpoint 10, 20, 0
Dcad3.Lines False
Dim snapPoint as Dcad3.AutoPoint
snapPoint.x = 11.0
snapPoint.y = 9.0
snapPoint.z = -2.0
Intersect1Snap snapPoint, True
msgbox "intersection point: " & snapPoint.x & ", " & snapPoint.y
& ", " & snapPoint.z
Dcad3.SetPoint snapPoint.x+5, snapPoint.y+5, snapPoint.z+5
Dcad3.Lines False
```

### **Intersect2Snap snapPoint1 as AutoPoint, snapPoint2 as AutoPoint, setThePoint as Boolean**

Description: given two lines designated by snapPoint1 and snapPoint 2, this method moves the cursor to the intersection of those two lines and optionally sets a point there. The data in snapPoint1 is changed to the actual coordinate for the intersection point.

Example:

```
Dcad3.Setpoint 0, 10, 0
Dcad3.Setpoint 20, 10, 0
Dcad3.Lines False
Dcad3.Setpoint 10, 0, 0
Dcad3.Setpoint 10, 20, 0
Dcad3.Lines False
Dim snapPoint1 as Dcad3.AutoPoint
Dim snapPoint2 as Dcad3.AutoPoint
snapPoint1.x = 13.0
snapPoint1.y = 9.5
snapPoint1.z = -2.0
snapPoint2.x = 9.77
snapPoint2.y = 14.5
snapPoint2.z = -1
Intersect2Snap snapPoint1, snapPoint2, True
msgbox "intersection point: " & snapPoint1.x & ", " &
snapPoint1.y & ", " & snapPoint1.z
Dcad3.SetPoint snapPoint1.x+5, snapPoint1.y+5, snapPoint1.z+5
Dcad3.Lines False
```



## IsAnythingSelected - Read\_Only

Data Type: Boolean

Description: Flag to determine if any entities are selected

Example:

```
IsSelected = Dcad3.IsAnythingSelected
```

## IsometricView

Description: switches the current DesignCAD view window to Isometric view angles.

Example:

```
Dcad3.IsometricView
```

## JoinEndpoints Params, ShowCmdLine as Boolean

Description: moves the points in the selection box to a common location at the geometric center of the included points.

Params.endpointOnly - Boolean ; if True, only affects endpoints in selected region

Params.selectOnly - Boolean ; if True, only affects selected entities

Params.range2D - Boolean ; if False, user must set enclose points in a 3D rectangle

Example:

```
Dcad3.Setpoint 0, 0, 0
Dcad3.Setpoint 0, 10, 0
Dcad3.Setpoint 10, 10, 0
Dcad3.Setpoint 10, 0, 0
Dcad3.Setpoint 0, 0, 0
Dcad3.Lines False
Dcad3.Setpoint 5, -5, 0
Dcad3.Setpoint 5, -35, 10
Dcad3.Lines False
Dcad3.Setpoint 8, 5, 5
Dcad3.Setpoint 12, 8, 10
Dcad3.Lines False
Dcad3.Setpoint 4, 7, 0
Dcad3.Setpoint 12, -8, 0
Params.Endpointonly = True
Dcad3.JoinEndpoints Params, False
```

## LayerOptions

Description: Opens the Layer Options Folder

Example:

```
Dcad3.LayerCommand
```

## Length

Description: Returns the length of the object the user (or the program) has set a point on.

Data Type: Double

Example:

```
Dcad3.Setpoint 0,0,0
```

```

Dcad3.Setpoint 10,0,0
Dcad3.Setpoint 10,10,0
Dcad3.Lines False
'set a point on the line and get its length
Dcad3.Setpoint 10,0,0
MsgBox "Length of the line is: " & Dcad3.Length

```

### **LightSource**

Description: opens the Light Sources Options folder

Example:

```
Dcad3.LightSource
```

### **Lines KeepGettingPts as Boolean**

Description: Draws a line consisting of one or more segments.

Example:

```
Dcad3.Lines True 'all points set manually by user
```

### **LineSnap snapPoint as AutoPoint, setThePoint as Boolean**

Description: snaps from the coordinate in snapPoint to the nearest line segment, and optionally sets a point.

Example:

```

Dim snapPoint as Dcad3.AutoPoint
Dcad3.Setpoint 0, 10, 0
Dcad3.Setpoint 20, 10, 0
Dcad3.Lines False
Dcad3.Setpoint 10, 0, 0
Dcad3.Setpoint 10, 20, 0
Dcad3.Lines False
snapPoint.x = 7
snapPoint.y = 7
snapPoint.z = -1
Dcad3.LineSnap snapPoint, True
Dcad3.Select2D 0

```

### **LineToCurve**

Description: converts a line to a spline curve which passes through the same control points

Example: see CurveToLine

### **LoadBitmap Params, ShowCmdLine as Boolean**

Params.fileName - String[250]

Description: Loads a bitmap (BMP) file from disk

Example:

```

Params.fileName = "C:\WINDOWS\PICTURE.BMP"
Dcad3.SetPoint 0,0,0
Dcad3.LoadBitmap Params, False

```

## **LoadSymbol Params, ShowCmdLine as Boolean, KeepGettingPoints as Boolean**

Params.fileName - String[250]

Params.fixedScale - Boolean

True - Loads the symbol using the scale at which it was drawn

False - The symbol is scaled by the distance between the handles

Params.selectLoad - Boolean

True - The symbol is automatically selected after it is loaded

False - The symbol is not selected after it is loaded.

Description: Loads a symbol drawing from disk

Example:

```
Params.fileName = "C:\DCAD\Symbols\Arch\Toilet.DW2"
```

```
Params.fixedScale = False
```

```
Params.selectLoad = True
```

```
Dcad3.LoadSymbol Params, False, False
```

## **MakePlane**

Description: Turns the selected line into a plane

Example:

```
Dcad3.MakePlane
```

## **MaterialOptions**

Description: opens the Material Options folder

Example:

```
Dcad3.MaterialCommand
```

## **Merge Params, ShowCmdLine as Boolean, KeepGettingPoints as Boolean**

Params.fileName - String[250]

Params.fixedScale - Boolean

True - Loads the drawing using the scale at which it was drawn

False - The drawing is scaled by the distance between handles

Params.selectLoad - Boolean

True - The drawing is automatically selected after it is loaded

False - The drawing is not selected after it is loaded.

Description: Merges an existing drawing into the current drawing

Example:

```
Params.fileName = "C:\DCAD3\Samples\HDRIVE.DC"
```

```
Params.fixedScale = Merge
```

```
Params.selectLoad = False
```

```
Dcad3.Merge Params, False
```

## **MidpointSnap snapPoint as AutoPoint, setThePoint as Boolean**

Description: snaps to the midpoint of the nearest line segment and optionally sets a point there. The data in snapPoint is updated to contain the coordinate of the midpoint.

Example:

```
Dim SnapPoint as
```

```
Dcad3.Setpoint 0, 0, 0
```

```

Dcad3.Setpoint 10, 0, 0
snapPoint.x = 0
snapPoint.y = 1
snapPoint.z = -1
Dcad3.MidpointSnap
MsgBox "Midpoint: " & snapPoint.x & ", " & snapPoint.y & _ ", "
& snapPoint.z

```

## Mirror Params, ShowCmdLine as Boolean

Description: makes a mirror image of the selected objects

Params.axis - Integer ;

```

0=x,
1=y,
2=z,
3=custom normal

```

Example:

```

Dcad3.Setpoint 0, 0, 0
Dcad3.Setpoint 10, 0, 0
Dcad3.Setpoint 20, 10, 0
Dcad3.Setpoint 10, 20, 0
Dcad3.Lines False
Dcad3.Setpoint 0, 0, 0
Dcad3.Select2D 0
Dcad3.Setpoint 0, -10, 0
Params.axis = 1 'direction of copy is along y
Dcad3.Mirror Params, False
Dcad3.FitToWindow

```

## MoveObject

Description: Move the selected object(s) to a new location

Example:

```

Dcad3.Setpoint 0, 0, 0
Dcad3.Setpoint 10, 10, 10
Dcad3.Box
Dcad3.Setpoint 0, 0, 0
Dcad3.select2d 0
'The handle is already at 0, 0, 0
'Set a point for new handle location and move the box
Dcad3.Setpoint 15, 15, 0
Dcad3.MoveObject

```

## New

Description: opens a new drawing document

Example:

```

Dcad3.New

```

## NewWindow

Description: opens a new view window for the current drawing.

Example:

```
Dcad3.NewWindow
```

## Open Params, ShowCmdLine as Boolean

Params.fileName - String[250]

**Note:** If ShowCmdLine is True, the filename is ignored and the Open File dialog box appears

---

Example:

```
Params.fileName = "d:\dc3win95\wormgear.dc"  
Dcad3.Open params, false
```

## Options

Description: opens the Options folders

Example:

```
Dcad3.Options
```

## Ortho

Description: forces all selected lines within 10° of parallel to the X, Y, or Z axis to become parallel to the appropriate axis

Example:

```
Dcad3.Setpoint 0, 0, 0  
Dcad3.Setpoint 10, 1, 0  
Dcad3.Setpoint 19, 10, 0  
Dcad3.Setpoint 20, 20, 0  
Dcad3.Lines False  
Dcad3.Setpoint 0, 0, 0  
Dcad3.Select2D 0  
Dcad3.Setpoint 0, 0, 0  
Dcad3.Setpoint 0, 0, 0  
Dcad3.Duplicate  
Dcad3.Ortho
```

## OrthoLine KeepGettingPts as Boolean

Description: Draws line parallel to the X, Y, or Z axis.

Example: Draw a straight line with 2 preset points, which the user can finish.

```
Dcad3.Setpoint 5,20,0  
Dcad3.Setpoint 20,20,0  
Dcad3.OrthoLine True
```

## Pan

Description: pans the drawing

Example:

```
Dcad3.Setpoint 0,0,0
Dcad3.Setpoint 10,0,0
Dcad3.Pan
```

## **Parallel**

Description: Draws a line, arc, or curve parallel to an existing line, arc, or curve

Example:

```
Dcad3.Setpoint 10,20,0
Dcad3.Setpoint 25,20,0
Dcad3.Lines False
Dcad3.Setpoint 15,20,0
Dcad3.Setpoint 15,0,10
Dcad3.Parallel
```

## **ParallelByDistance Params, ShowCmdLine as Boolean**

Description: Draws a line or curve parallel to another at a specified distance in the direction chosen.

Params.distance - Single

Example:

```
Dcad3.Setpoint 10,20,0
Dcad3.Setpoint 25,20,0
Dcad3.Lines False
Dcad3.Setpoint 15,20,0
Dcad3.Setpoint 15,0,10
Params.distance = 25
Dcad3.ParallelByDistance Params, False
```

## **ParallelProjection**

Description: Changes DesignCAD's view settings to Parallel Projection

Example:

```
Dcad3.ParallelProjection
```

## **Paste**

Description: Pastes the contents of the clipboard into the drawing.

Example: See Cut

## **PerpendicularFrom Params, ShowCmdLine as Boolean**

Description: Draws a perpendicular of specified length from a specified line in a selected direction.

Params.length - Single

Example:

```
Dcad3.Setpoint 0,0,0
Dcad3.Setpoint 10,10,0
Dcad3.Lines False
Dcad3.Setpoint 4,4,0
```

```
Dcad3.Setpoint 4, -10, 0
Params.Length = 10
Dcad3.PerpendicularFrom Params, False
```

## **PerpendicularTo**

Description: Draws a line from a specific starting point which is perpendicular to a chosen line.

Example:

```
Dcad3.Setpoint 0,0,0
Dcad3.Setpoint 10,5,0
Dcad3.Lines False
Dcad3.Setpoint 4,5,0
Dcad3.Setpoint 5,2.5,0
Dcad3.PerpendicularTo
```

## **PerspectiveProjection**

Description: Changes DesignCAD's view settings to Perspective Projection

Example:

```
Dcad3.PerspectiveProjection
```

## **Plane KeepGettingPts as Boolean**

Description: Draws a plane

Example:

```
Dcad3.Setpoint 0, 0, 0
Dcad3.Setpoint 0, 10, 0
Dcad3.Setpoint 10, 10, 0
Dcad3.Setpoint 10, 0, 0
Dcad3.Setpoint 0, 0, 0
Dcad3.Plane False
```

## **PlaneSubtract**

Description: subtracts plane 1 from plane 2

Example:

```
Dcad3.Setpoint 0, 0, 0
Dcad3.Setpoint 0, 10, 0
Dcad3.Setpoint 10, 10, 0
Dcad3.Setpoint 10, 0, 0
Dcad3.Setpoint 0, 0, 0
Dcad3.Plane False
Dcad3.Setpoint 1, 1, 0
Dcad3.Setpoint 9, 1, 0
Dcad3.Setpoint 9, 9, 0
Dcad3.Setpoint 1, 9, 0
Dcad3.Plane False
Dcad3.Setpoint 1, 1, 0
Dcad3.Setpoint 0, 0, 0
Dcad3.PlaneSubtract
```

## PointMark Params, ShowCmdLine as Boolean

Params.pointSize - Single

Params.pointType - Integer ;

0=cross

1=cross+box

2=cross+circle

3=cross+circle+box

Example:

```
Params.pointType = 2
Dcad3.Setpoint 0,0,0
Dcad3.Setpoint 20,0,0
Dcad3.Setpoint 20,15,0
Dcad3.Setpoint 0,15,0
Dcad3.Pointmark Params, True
```

## PointMove

Description: moves a point in one or more objects to a new location

Example:

```
Dcad3.Setpoint 0, 0, 0
Dcad3.Setpoint 0, 10, 0
Dcad3.Setpoint 10, 10, 0
Dcad3.Setpoint 10, 0, 0
Dcad3.Setpoint 0, 0, 0
Dcad3.Lines False
Dcad3.Setpoint 0, 0, 0
Dcad3.Setpoint 5, 0, 0
Dcad3.PointMove
```

## PointSelectMode

Description: Toggles DesignCAD into or out of PointSelectMode

Example:

```
Dcad3.PointSelectMode
```

## Polygon Params, ShowCmdLine as Boolean

Description: Draw a regular polygon by placing points along one edge.

Params.createAs - Integer ;

0=line

1=plane

Params.nSide - Integer ; 3 to 198 sides

Example: Draw a five sided polygon whose rightmost edge is vertical

```
Params.nSide = 5
Params.createAs = 2
Dcad3.Setpoint 10,0,0
Dcad3.Setpoint 10,10,0
```



```
Dcad3.Setpoint 20,10,0
Dcad3.Polygon Params, True
```

### **Polygon2 Params, ShowCmdLine as Boolean**

Description: Draws a regular polygon from center to radius point (vertex or midpoint of edge).

Params.createAs - Integer ;

0=line  
1=plane

Params.nSide - Integer ; 3 to 198 sides

Params.orientation - Integer ;

0=point on vertex  
1=midpoint of side

Example:

```
Params.createAs = 1
Params.orientation = 0
Dcad3.Setpoint 0,0,0
Dcad3.Setpoint 10,0,0
Dcad3.Polygon2 Params, False
Params.orientation = 1
Dcad3.Setpoint 30,0,0
Dcad3.Setpoint 40,0,0
Dcad3.Polygon2 Params, False
```

### **PullOut Params, ShowCmdLine as Boolean**

Description: Draws text with an arrow.

Params.textContent - String[80]

Params.textSize - Single

Params.textLocation - Integer ;

0=right,  
1=above arrow,  
2=below

Example:

```
Params.textContent = "This is the origin (0,0,0)"
Params.textSize = 1.0
Params.textLocation = 0
Dcad3.Setpoint 0,0,0
Dcad3.Setpoint 20,0,0
Dcad3.Pullout Params, False
```

### **Quit**

Description: Closes DesignCAD without saving the drawing

Example:

```
Dcad3.Quit
```

### **Redo**

Description: reverses the results of the last Undo

Example:

```
Dcad3.Redo
```

### **Regenerate**

Description: regenerates the drawing in the currently active view

Example:

```
Dcad3.Regenerate
```

### **RegenerateAll**

Description: regenerates all the views in the currently active drawing

Example:

```
Dcad3.RegenerateAll
```

### **ResetWorkplane**

Description: revokes the axis alignments caused by SetWorkplane

Example:

```
Dcad3.ResetWorkplane
```

### **Rotate Params, ShowCmdLine as Boolean**

Description: rotate the selected objects about the chosen axis

Params.angle - Single

Params.axis - Integer ; 0=x,

1=y,

2=z,

3=2-point,

4=line,

5=plane

Example:

```
Dcad3.Setpoint 0, 0, 0
Dcad3.Setpoint 10, 10, 10
Dcad3.Box
Dcad3.Setpoint 0, 0, 0
Dcad3.select2d 0
Dcad3.Setpoint 0, 0, 0
Dcad3.Setpoint 10, 10, 10
params.axis = 3
params.angle = 45
Dcad3.Rotate params, True
```

### **RunBasicCAD Params. ShowCmdLine as Boolean**

Description: runs a BasicCAD program or DesignCAD macro from the VB program. If ShowCmdLine is True, the Open File dialog box lets the user choose which filename to use.

Params.fileName - string[250] – the name of the BasicCAD program to run.

Example:

```
Params.fileName = "*\ST.BSC"
```

```
RunBasicCAD Params, False
```

## Save

Description: Saves the current document

Example:

```
Dcad3.Save
```

## SaveAs fileName as String[250]

Description: saves the current drawing under the name specified in fileName (up to 250 characters)

**Note:** To show the SaveAs Dialog box, use an empty string "" for the filename

---

Example:

```
Dcad3.SaveAs "MyFile.DC"
```

## SaveAsSpecial Params, ShowCmdLine as Boolean

Params.fileName - String[250]

Params.saveAs2D - Boolean

True - Saves a 2D projection of the current view

False - Saves a 3D drawing

Params.saveDouble - Boolean

True - Saves drawing in double precision (incompatible with older versions of DCAD)

False - Saves drawing in single precision (readable by older versions of DesignCAD)

Params.saveHidden - Boolean

True - Saves a projection of current view with hidden lines removed

False - Saves the complete drawing

ShowCmdLine - Boolean

True - shows the SaveAs dialog box - Params settings ignored.

False - takes the user-defined Params, and doesn't show the dialog box

Description: Saves the current drawing under a different name, possibly as a 2D projection or with hidden lines removed, or in single precision

Example: Save a 2D projection of the current view in double precision, without hiding lines

```
Params.fileName = "D:\Dcad3\Test5.dw2"
```

```
Params.saveAs2D = True
```

```
Params.saveDouble = True
```

```
Params.saveHidden = False
```

```
Dcad3.SaveAsSpecial Params, False
```

## SaveBitmap Params, ShowCmdLine as Boolean

Params.fileName - String[250]

Description: Saves a bitmap of the current view window, or (if two points are preset) a rectangular portion of the screen. If one point is preset, the user will have to set a second point for the opposite corner of the rectangular region to save.

Example:

```
Dcad3.SetPoint 20, 0, 0
Dcad3.SetPoint 20, 40, 0
Dcad3.Sphere Params, False
Params.fileName = "sphere.bmp"
Dcad3.SaveBitmap Params, False
```

### **SaveCurrentView Params, ShowCmdLine as Boolean**

Params.viewName - String[20]

Description: Saves the current view settings as a named view in the Viewing Toolbox viewlist

Example:

```
Dcad3.Xangle = 60
Dcad3.Yangle = 45
Dcad3.Regenerate
Params.viewName = "MyView"
Dcad3.SaveCurrentView Params, False
```

### **SaveSelected Params, ShowCmdLine as Boolean**

Params.fileName - String[250]

Params.saveAs2D - Boolean

True - Saves a 2D projection of the current view

False - Saves a 3D drawing

Params.saveDouble - Boolean

True - Saves drawing in double precision (incompatible with older versions of DCAD)

False - Saves drawing in single precision (readable by older versions of DesignCAD)

Params.saveHidden - Boolean

True - Saves a projection of the current view with hidden lines removed

False - Saves the complete drawing

ShowCmdLine - Boolean

True - shows the SaveAs dialog box - Params settings ignored.

False - takes the user-defined Params, and doesn't show the dialog box

Description: Saves the current selection set as a separate drawing under a different name, possibly as a 2D projection or with hidden lines removed, or in single precision

### **ScaleObject Params, ShowCmdLine as Boolean**

Description: The scale command allows you to resize an object by a different scale factor along each axis.

**Note:** If ShowCmdLine is True, the user must press Enter before the command will execute.

---

Params.xScale - Single

Params.yScale - Single

Params.zScale - Single

Example:

```
Dcad3.Setpoint 0, 0, 0
Dcad3.Setpoint 10, 10, 10
Dcad3.Box
Dcad3.Setpoint 0, 0, 0
```

```
Dcad3.select2d 0
params.xScale = 3
params.yScale = 2
params.zScale = 1.25
Dcad3.ScaleObject params, False
```

### **ScaleOrtho Params, ShowCmdLine as Boolean**

Description: resizes the selected object by a specified scale. The scaling is equal along all three axes.

**Note:** If ShowCmdLine is True, the user must press Enter before the command will execute.

---

Params.zoomFactor - Single

Example:

```
Dcad3.Setpoint 0, 0, 0
Dcad3.Setpoint 10, 10, 10
Dcad3.Box
Dcad3.Setpoint 0, 0, 0
Dcad3.select2d 0
params.zoomFactor = 1.25
Dcad3.ScaleOrtho params, True
```

### **SectionCutoff Params, ShowCmdLine as Boolean**

Params.selectOnly - Boolean ; if True, only affects selected items

Example:

```
Dcad3.Setpoint 0, 0, 0
Dcad3.Setpoint 10, 10, 10
Dcad3.Box
Dcad3.Setpoint 0, 0, 0
Dcad3.Setpoint 10, 10, 10
Dcad3.Lines False
Dcad3.SelectAll
Dcad3.Setpoint 5, 5, 5
Dcad3.Setpoint 11, 11, 11
Params.selectOnly = True
Dcad3.SectionCutoff Params, False
```

### **SectionDelete Params, ShowCmdLine as Boolean**

Params.selectOnly - Boolean ; if True, only affects selected items

Example:

```
Dcad3.Setpoint 0, 0, 0
Dcad3.Setpoint 10, 10, 10
Dcad3.Box
Dcad3.Setpoint 0, 0, 0
Dcad3.Setpoint 10, 10, 10
```

```
Dcad3.Lines False
Dcad3.SelectAll
Dcad3.Setpoint 5, 5, 5
Dcad3.Setpoint 11, 11, 11
Params.selectOnly = True
Dcad3.SectionDelete Params, False
```

### **Segment Params, ShowCmdLine as Boolean**

Description: divides a line into a specified number of segments of equal length

Params.nSegment - Integer

Example:

```
parameter.nSegment = 10
Dcad3.Setpoint 0, 0, 0
Dcad3.Setpoint 10, 0, 0
Dcad3.Lines False
Dcad3.Setpoint 0, 0, 0
Dcad3.Select2D 0
Dcad3.Segment parameter, False
```

### **Select2D selectKeys as Integer**

selectKeys = 0; new selection of item(s) enclosed by rectangle (or nearest item if single point set).

selectKeys = 1; Shift Key pressed. Add item picked (or enclosed by rectangle) to current selected set.

selectKeys = 2; Control Key pressed. New selection of items touched by and/or enclosed by rectangle.

selectKeys = 3; Control + Shift keys pressed. Add item(s) enclosed by and/or touched by selection rectangle.

Description: Selects items enclosed in a 2D selection rectangle (or touched by a single point)

Example:

```
Dcad3.Setpoint 0,0,0
Dcad3.Setpoint 0,10,0
Dcad3.Circle1 Params, False
Dcad3.Setpoint -12, -12, 0
Dcad3.Setpoint 12, 12, 0
Dcad3.Select2D 0
Dcad3.ClearSelection
'You can also select one object by setting a 'single point. For
example, we can select the 'circle by setting a point at the
center and 'calling Select2D.
Dcad3.Setpoint 0, 0, 0
Dcad3.Select2D 0
```

### **Select3D SelectKeys as Integer**

SelectKeys = 0; new selection of item(s) enclosed by rectangle (or nearest item if single

point set).

SelectKeys =1; Shift Key pressed. Add item picked (or enclosed by rectangle) to current selected set.

SelectKeys=2; Control Key pressed. New selection of items touched by and/or enclosed by rectangle.

SelectKeys=3; Control + Shift keys pressed. Add item(s) enclosed by and/or touched by selection rectangle.

Description: selects the items enclosed by a 3D selection box (or picked by a single point)

Example:

```
Dcad3.Setpoint 0, 0, 0
Dcad3.Setpoint 0, 10, 0
Dcad3.Sphere Params, False
Dcad3.Setpoint -11, -11, -11
Dcad3.Setpoint 11, 11, 11
Dcad3.Select3D 0
```

### **SelectAll**

Description: Selects all entities in the drawing

Example:

```
Dcad3.SelectAll
```

### **SelectLastEntity**

Description: Selects the last entity drawn

Example:

```
Dcad3.SelectLastEntity
```

### **SelectMode2D**

Description: Puts DesignCad into 2D Selection Mode. Cursor becomes normal Windows-style arrow pointer. Snap functions operate on nearest screen location instead of nearest 3D location.

Example:

```
Dcad3.SelectMode2D
```

### **SelectMode3D**

Description: Puts DesignCAD into 3D Selection Mode. Cursor becomes a 3D "snowflake". Snap functions operate on nearest 3D locations rather than on nearest pixel location in the displayed projection.

Example:

```
Dcad3.SelectMode3D
```

### **SetDrawingHandles**

Description: Places handles in the drawing, so it can be merged in at a specific location and/or scale

Example:

```
Dcad3.SetPoint 0, 0, 0
```

```
Dcad3.SetPoint 10, 0, 0
Dcad3.SetDrawingHandles
```

### **SetGridCenter**

Description: sets the location for the Display Grid's center point

Example:

```
Dcad3.Setpoint 10, 10, 10
Dcad3.SetGridCenter
```

### **SetHandles**

Description: set up to three points for selection handles

Example:

```
Dcad3.Setpoint 0, 0, 0
Dcad3.Setpoint 10, 10, 10
Dcad3.Box
Dcad3.Setpoint 0, 0, 0
Dcad3.select2d 0
Dcad3.Setpoint 0, 0, 0
Dcad3.Setpoint 10, 0, 0
Dcad3.Setpoint 10, 0, 10
Dcad3.SetHandles
```

### **SetLayerStatus Layernum as Integer, Visible as Boolean, Editable as Boolean**

Description: allows you to make layers invisible or non-editable

**Note:** If you set a layer to be invisible, it will automatically be uneditable, regardless of the value of the Editable argument

---

Example:

```
Dim I as Integer
For I = 2 to 32
SetLayerStatus I, False, False
Next
```

### **SetPoint x as Double, y as Double, z as Double**

Description: Sets a point at a specific location

Example:

```
Dim X as Double
Dim Y as Double
Dim Z as Double
X= 20
Y = 30
Z = 0
Dcad3.Setpoint X, Y, Z
Dcad3.Setpoint X+10, Y-10, Z +5
Dcad3.Lines False
```

### **SetPointPolar Params, showDlg as Boolean**



Params.angle - Single

Params.Distance - Single

Params.relativeToOrigin - Boolean

True - relative to Origin (always)

False - relative to last point (unless no previous points have been set since the last drawing command)

showDlg - Boolean

True - show the Point Polar dialog box, disregarding parameters

False - use the specified distance and angle parameters; don't show the dialog box

Description: sets a point at a specified angle and distance from a previously set point

Example:

```
Dcad3.Setpoint 10,20, 0
Params.angle = 45
Params.distance = 25
Dcad3.SetPointPolar Params, False
Dcad3.Lines, False
```

### **SetPointRelative dx as Double, dy as Double, dz as Double, showDlg as Boolean**

Description: sets a point at specified X, Y, and Z offsets from a previously set point

Example:

```
Dim Pi as Double
Pi = 4* Atn(1)
Dcad3.Setpoint 10, 20, 0
Params.angle = 45
Params.distance = 25
Dcad3.SetPointPolar Params, False
Dcad3.SetPointRelative -25*Cos(Pi/4), 0, 0
Dcad3.SetPointRelative 0, -25*Sin(Pi/4), 0
Dcad3.Lines False
```

### **SetPoints nPts as Integer, xArray As Object, yArray As Object, zArray As Object**

Description: Sets a sequence of points whose values are stored in a set of arrays of X, Y, and Z values.

**Note:** This command is only useable with VB 4.0

---

Example:

```
Dim x(2) As Double
Dim y(2) As Double
Dim z(2) As Double
x(0) = 0#
x(1) = 10#
y(0) = 0#
y(1) = 20#
z(0) = 0#
z(1) = 30#
```

```
Dc3Doc.SetPoints 2, x, y, z
Dc3Doc.Box
```

### **SetSnapGridSize**

Description: Opens the Grid Options folder

Example:

```
Dcad3.SetSnapGridSize
```

### **SetView**

Description: Allows user to change the viewing angles and distance by dragging the mouse

Example:

```
Dcad3.SetView
```

### **SetWorkplane**

Description: Realigns the X, Y, and Z axes temporarily according to points set by the user

Point 1: new (temporary) origin

Point 2: sets (temporary) positive X direction

Point 3: sets a third point for the workplane

Point 4: sets a point to determine the "front" side of the workplane

Example: Define a workplane across the diagonal of a cube

```
Dcad3.SetPoint 0, 0, 0
Dcad3.SetPoint 10, 10, 10
Dcad3.Box
Dcad3.SetPoint 0, 0, 0
Dcad3.SetPoint 10, 0, 10
Dcad3.SetPoint 10, 10, 10
Dcad3.SetPoint 10, 0, 0
Dcad3.SetWorkPlane
'at this point, X, Y, and Z are relative to the 'working plane
we have just established
Dc3Doc.SetPoint 0, 0, 0
Dc3Doc.SetPoint 14.14, 0, 0
Dc3Doc.SetPoint 14.14, 10, 0
Dc3Doc.SetPoint 0, 10, 0
Dc3Doc.Plane False
Dc3Doc.ResetWorkplane
```

### **Shade Params, ShowCmdLine as Boolean**

Description: Shade the drawing.

Note: If two points are preset, then only that rectangular area will be shaded. If no points are set, the entire drawing will be shaded. (Unless ShowCmdLine is True, in which case the user can choose to shade the whole drawing or only a portion)

---

Params.quickShading - boolean – shade quick (true) or smooth (false)

Params.showText - boolean – Show text after shading

Params.showDimensions - boolean – show dimensions after shading

Params.showLines - boolean – show lines after shading

Example:

```
Dcad3.Material = 14    'set material to be oak
Dcad3.Setpoint 0,0,0
Dcad3.Setpoint 0,10,0
Params.nLongitude = 20
Params.nLatitude = 20
Dcad3.Sphere Params, False
Params.quickShading = False
Dcad3.Shade Params, ShowCmdLine
```

### **Show GiveUserControl As Boolean**

Description: Makes DesignCAD visible.

GiveUserControl - Boolean

False – DesignCAD is visible, but may appear behind other applications.

True – DesignCAD is made visible and is given the focus.

Example:

```
Dcad3.Show False
```

### **ShowHide**

Description: Opens the View Options folder

Example:

```
Dcad3.ShowHide
```

### **ShowTextAsOutline outlineFlag as Boolean**

outlineFlag - Boolean

True – Shows text in outline form

False – Shows filled text

Description - displays text in outline format or filled format

Example:

```
Dcad3.ShowTextAsOutline
```

### **SideView**

Description: Switches the current view window settings to show a Side View of the drawing

Example:

```
Dcad3.SideView
```

### **Slice Params, ShowCmdLine as Boolean**

Description: Slices the drawing (or only selected objects) along a plane.

Params.selectOnly - Boolean ; if True, only selected objects are sliced

Example: Slice away all parts above the XY plane.

```
Dcad3.Setpoint 0,0,0
Dcad3.Setpoint 10,0,0
Dcad3.Setpoint 10,0,10
```

```
Dcad3.Setpoint 0,10,0
Params.selectOnly = False
Dcad3.Slice Params,False
```

## SmoothLines

Description: smooths the selected lines into curves

Example:

```
Dim i As Integer
For i = 0 To 15
Dcad3.Setpoint i * 1#, i ^ 2# - 4 * i, 0
Next i
Dcad3.lines False
Dcad3.Setpoint 0, 0, 0
Dcad3.Select2D 0
Dcad3.Smoothlines
```

## SnapGrid

Description: toggles the Snap Grid on or off

Example:

```
Dcad3.SnapGrid
```

## SolidAdd

Description: Adds the two solids together which are picked by two points.

Example:

```
Dcad3.Setpoint 10, 10, 10
Dcad3.Setpoint 10, 10, 20
Dcad3.Sphere Params, True
Dcad3.Setpoint 15, 10, 10
Dcad3.Setpoint 0, 0, 0
Dcad3.Box
Dcad3.Setpoint 10, 10, 20
Dcad3.Setpoint 0, 0, 0
Dcad3.SolidAdd
```

## SolidDefine

Description: Combines the selected items into a "Solid" object. This does not have any kind of error checking. You can select a circle and a line and define them as a solid; this command won't care. However, don't expect meaningful results in such a case if you do a SolidSubtract or SolidAdd.

Example:

```
Dcad3.Setpoint 0,0,0
Dcad3.Setpoint 10,0,0
Dcad3.Setpoint 10,10,0
Dcad3.Plane
Dcad3.Setpoint 0,0,0
Dcad3.Setpoint 10,0,0
Dcad3.Setpoint 10,0,10
```

```
Dcad3.Plane
Dcad3.Setpoint 0,0,0
Dcad3.Setpoint 10,10,0
Dcad3.Setpoint 10,0,10
Dcad3.Plane
Dcad3.Setpoint 10,0,0
Dcad3.Setpoint 10,10,0
Dcad3.Setpoint 10,0,10
Dcad3.Plane
Dcad3.SelectAll
Dcad3.SolidDefine
```

### **SolidExplode**

Description: Explodes the selected solid into its component planes and grids.

Example:

```
Dcad3.Setpoint 0,0,0
Dcad3.Setpoint 10,10,10
Dcad3.Box
Dcad3.Setpoint 0,0,0
Dcad3.Select2D 0
Dcad3.SolidExplode
```

### **SolidIntersect**

Description: Finds the intersection of two solids. That is, it returns the shape that is a part of both of the picked solids.

Example:

```
Dcad3.Setpoint 10, 10, 10
Dcad3.Setpoint 10, 10, 20
Dcad3.Sphere Params, True
Dcad3.Setpoint 15, 10, 10
Dcad3.Setpoint 0, 0, 0
Dcad3.Box
Dcad3.Setpoint 0, 0, 0
Dcad3.Setpoint 10, 10, 20
Dcad3.SolidIntersect
```

### **SolidSubtract**

Description: Subtracts the first solid picked from the second. In this example, the box is subtracted from the sphere.

Example:

```
Dcad3.Setpoint 10, 10, 10
Dcad3.Setpoint 10, 10, 20
Dcad3.Sphere Params, True
Dcad3.Setpoint 15, 10, 10
Dcad3.Setpoint 0, 0, 0
```

```
Dcad3.Box
Dcad3.Setpoint 0, 0, 0
Dcad3.Setpoint 10, 10, 20
Dcad3.SolidSubtract
```

### **Sphere Params, ShowCmdLine as Boolean**

Description: Draws a sphere

Params.orientation - Integer ;

0=point on vertex  
1=midpoint of edge  
2=point on pole

Params.nLongitude - Integer ; number of facets from pole to pole

Params.nLatitude - Integer ; number of facets around "equator"

Example:

```
Dcad3.Setpoint 20,0,0
Dcad3.Setpoint 40,0,0
Params.nLatitude = 20
Params.nLongitude = 20
Params.orientation = 1
Dcad3.Sphere Params, False
```

### **Stretch Params, ShowCmdLine as Boolean**

Description: stretches the items enclosed in the range box.

Params.selectOnly - Boolean ; if True, only affects selected items

Params.range2D - Boolean; if False, user must enclose stretched area in a 3D range box

Example:

```
Dcad3.Setpoint 0, 0, 0
Dcad3.Setpoint 10, 10, 10
Dcad3.Box
Dcad3.Setpoint 8, -1,-1
Dcad3.Setpoint 11,11,11
Dcad3.Setpoint 10,5,0
Dcad3.Setpoint 12,5,0
Params.selectOnly = False
Params.range3D = True
Dcad3.Stretch Params, False
```

### **SurfaceConnect Params, ShowCmdLine as Boolean**

Params.connectType - Integer ;

0=straight,  
1=curved,  
2=smooth

Params.nSurface - Integer

Params.nBreak - Integer

Example:

```
Dcad3.Setpoint 30, 0, 0
```

```

Dcad3.Setpoint 30, 30, 20
Dcad3.Setpoint 30, 20, 40
Dcad3.Curve Params, False, False
Dcad3.Setpoint 10, 20, 40
Dcad3.Setpoint 10, 30, 20
Dcad3.Setpoint 10, 0, 0
Dcad3.Curve Params, False, False
Params.nSurface = 30
Params.nbreak = 20
Params.connectType = 2
Dcad3.Setpoint 10, 30, 20
Dcad3.Setpoint 30, 30, 20
Dcad3.SurfaceConnect Params, True

```

### **SurfaceIntersect**

**Description:** Draws a line along the intersection of two surfaces.

**Example:**

```

Dcad3.Setpoint 0,0,0
Dcad3.Setpoint 20,0,0
Dcad3.Setpoint 20,10,0
Dcad3.Setpoint 0,10,0
Dcad3.Plane False
Dcad3.Setpoint 10,0,-10
Dcad3.Setpoint 10,0,10
Dcad3.Setpoint 10,20,10
Dcad3.Setpoint 10, 20,10
Dcad3.Plane False
'Set a point on each surface, then find their 'intersection
Dcad3.Setpoint 0,0,0
Dcad3.Setpoint 10,0,-10
Dcad3.SurfaceIntersect

```

### **SurfacePatch Params, ShowCmdLine as Boolean**

**Description:** creates a Coon Patch surface between 3 or 4 lines or curves. The lines or curves must be connected end to end so as to form a closed perimeter, but they must be separate entities.

**Params.nPlane1** - Integer

**Params.nPlane2** - Integer

**Example:**

```

Dcad3.Setpoint 10, 0, 0
Dcad3.Setpoint 30, 0, 0
Dcad3.Lines False
Dcad3.Setpoint 30, 0, 0
Dcad3.Setpoint 30, 30, 20
Dcad3.Setpoint 30, 20, 40
Dcad3.Curve Params, False, False
Dcad3.Setpoint 30, 20, 40
Dcad3.Setpoint 10, 20, 40

```

```

Dcad3.Lines False
Dcad3.Setpoint 10, 20, 40
Dcad3.Setpoint 10, 30, 20
Dcad3.Setpoint 10, 0, 0
Dcad3.Curve Params, False, False
Params.nPlane1 = 30
Params.nPlane2 = 20
Dcad3.Setpoint 10, 30, 20
Dcad3.Setpoint 30, 30, 20
Dcad3.Setpoint 20, 0, 0
Dcad3.Setpoint 20, 20, 40
Dcad3.SurfacePatch Params, True

```

### **Sweep Params, ShowCmdLine as Boolean**

Description: create a 3D object by sweeping a line, curve, or surface along a circular or helical path.

Params.nCopy - Integer

Params.angle - Single

Params.offset - Single

Params.axis - Integer ;

```

0=x,
1=y,
2=z,
3=2-point,
4=line

```

Example: Draw a circle, then create a "donut" by sweeping it

```

Dcad3.Setpoint 10, 0, 0
Dcad3.Setpoint 10, 2, 0
Dcad3.Circle1 Params, False
Dcad3.Setpoint 10, 0, 0
Dcad3.Select2D 0
Dcad3.Setpoint 0, 0, 0
Params.axis = 1
Params.nCopy = 20
Params.angle = 360
Params.offset = 0
Dcad3.Sweep Params, False

```

### **TangentBetweenCircles**

Description: Draws a line tangent to two circles

Example:

```

Dcad3.Setpoint 10,10,0
Dcad3.Setpoint 20,10,0
Dcad3.Circle1 Params, False
Dcad3.Setpoint 40,10,0
Dcad3.Setpoint 45,10,0
Dcad3.Circle1 Params, False

```



```
Dcad3.Setpoint 10,10,0
Dcad3.Setpoint 40,10,0
Dcad3.TangentBetweenCircles
```

### **TangentFromCircle**

Description: Draws line tangent to a circle, starting from a specific point on the circle, in the direction given by the second point. The length of the tangent line drawn is determined by the projection of the line from point 1 to point 2 along the tangent direction. The first point must be very close to the circle or directly on it for the command to succeed.

Example:

```
Dcad3.Setpoint 10,10,0
Dcad3.Setpoint 20,10,0
Dcad3.Circle1 Params, False
Dcad3.Setpoint 20,10,0
Dcad3.Setpoint 0,30,0
Dcad3.TangentFromCircle
```

### **TangentToCircle**

Description: Draws a line from a point to the tangent of a circle

Example:

```
Dcad3.Setpoint 10,10,0
Dcad3.Setpoint 20,10,0
Dcad3.Circle1 Params, False
Dcad3.Setpoint 30,40,0
Dcad3.Setpoint 10,10,0
Dcad3.TangentToCircle
```

### **Text2D Params, ShowCmdLine as Boolean**

Description: Draws text that always appears "flat" regardless of the viewing angles.

Params.textContent - String[80]

Params.textSize - Single

Params.textStyle - Integer ;

```
0=normal
1=bold
2=italic
3=bold italic
```

Params.textJust - Integer ;

```
0=left
1=center
2=right
```

Example:

```
Params.textContent = "This is a string of 2D text."
Params.textSize = 5
Params.textStyle = 1
Params.textJust = 0
Dcad3.Setpoint 0,0,0
Dcad3.Text2D Params, False
```

## **Text3D Params, ShowCmdLine as Boolean**

Description: Draws text at any 3D orientation.

Params.textContent - String[80]

Params.textSize - Single

Params.createAs - Integer ;

0=text

1=vector text

Params.textStyle - Integer ;

0=normal

1=bold

2=italic

3=bold italic

Params.textJust - Integer ;

0=left

1=center

2=right

Example:

```
Params.createAs = 0
Params.textContent = "This is a string of text."
Params.textSize = 5
Params.textStyle = 3
Params.textJust = 2
Dcad3.Setpoint 0,0,0
Dcad3.Text3D Params, False
```

## **TextArc Params, ShowCmdLine as Boolean**

Description: draws text in an arc

Params.textContent - String[80]

Params.textScale - Single

Params.createAs - Integer

Params.textStyle - Integer ;

0=normal,

1=bold,

2=italic,

3=bold italic

Example:

```
Params.textContent = "The Arc of all Arcs"
Params.textScale = 1.2
Params.createAs = 0
Params.textStyle = 2
Dcad3.Setpoint 0,0,0
Dcad3.Setpoint 30,20,0
Dcad3.Setpoint 60,0,0
Dcad3.TextArc Params, False
```

## **TileHorizontal**

Description: Tiles the view windows horizontally

## TileVertical

Description: Tiles the view windows vertically

## TopView

Description: changes view settings to show a Top view of the drawing

## TrimBetweenTwoLines

Description: Trims a line between two other lines. The second and third line do not have to intersect the first line, but they should intersect the first line if extended far enough. All three lines must lie in the same plane.

Example:

```
Dcad3.Setpoint 0, 0, 0
Dcad3.Setpoint 10, 0, 0
Dcad3.Lines False
Dcad3.Setpoint 5, 5, 0
Dcad3.Setpoint 5, 15, 0
Dcad3.Lines False
Dcad3.Setpoint 6, 5, 0
Dcad3.Setpoint 6, 15, 0
Dcad3.Lines False
Dcad3.Setpoint 5.5, 0, 0
Dcad3.Setpoint 5, 5, 0
Dcad3.Setpoint 6, 5, 0
Dcad3.TrimBetweenTwoLines
```

## TrimDoubleLines

Description: Trims the intersection of two pairs of lines (Only works in 2D Drafting Mode)

Example:

```
Dcad3.Setpoint 0, 0, 0
Dcad3.Setpoint 10, 0, 0
Dcad3.Lines False
Dcad3.Setpoint 0, 1, 0
Dcad3.Setpoint 10, 1, 0
Dcad3.Lines False
Dcad3.Setpoint 5, 5, 0
Dcad3.Setpoint 5, -5, 0
Dcad3.Lines False
Dcad3.Setpoint 6, 5, 0
Dcad3.Setpoint 6, -5, 0
Dcad3.Lines False
Dcad3.Setpoint 4.5, -.5, 0
Dcad3.Setpoint 6.5, 1.5, 0
Dcad3.TrimDoubleLines
```

## TrimOneLine Params, ShowCmdLine as Boolean

Description: Shortens (or lengthens) the first line to its intersection with the second line.

Params.trimShortEnd - Boolean ; if True, always trims shorter end of line

Example:

```
Dcad3.Setpoint 0, 0, 0
Dcad3.Setpoint 10, 0, 0
Dcad3.Lines False
```

```
Dcad3.Setpoint 5, 5, 0
Dcad3.Setpoint 5, 15, 0
Dcad3.Lines False
Dcad3.Setpoint 5, 5, 0
Dcad3.Setpoint 5, 0, 0
Params.trimShortEnd = True
Dcad3.TrimOneLine Params, False
```

### **TrimTwoLines Params, ShowCmdLine as Boolean**

Description: Trims two lines to their intersection

Params.trimShortEnd - Boolean ; if True, always trims shorter end of lines

Example:

```
Dcad3.Setpoint 0, 0, 0
Dcad3.Setpoint 10, 0, 0
Dcad3.Lines False
Dcad3.Setpoint 5, 5, 0
Dcad3.Setpoint 5, 15, 0
Dcad3.Lines False
Dcad3.Setpoint 5, 5, 0
Dcad3.Setpoint 5, 0, 0
Params.trimShortEnd = True
Dcad3.TrimTwoLines Params, False
```

### **Undo**

Description: reverses the results of the previous command.

Example:

```
Dcad3.Undo
```

### **VectorConvert**

Description: converts a shape to a line entity that approximates the original shape

Example:

```
Dcad3.Setpoint 0, 0, 0
Dcad3.Setpoint 10, 0, 0
Dcad3.Setpoint 20, 10, 0
Dcad3.Setpoint 25, 5, 0
Dcad3.Setpoint 20, 15, 0
Dcad3.Setpoint 10, 20, 0
Dcad3.Curve Params, False, False
Dcad3.Setpoint 10, 20, 0
Dcad3.Select2D 0
Dcad3.VectorConvert
```

### **Volume**

Description: Returns the volume of the object the user (or the program) has set a point on.

Data Type: Double

### Example:

```
Params.nFacet = 20
Dcad3.Setpoint 0,0,0
Dcad3.Setpoint 10,0,0
Dcad3.Setpoint 10,10,0
Dcad3.Cylinder Params, False
'set a point on the cylinder and get its volume
Dcad3.Setpoint 10,0,0
MsgBox "Volume of the cylinder is: " & Dcad3.Volume
```

### Wall Params, ShowCmdLine as Boolean

Description: Draws a 3D wall of preset thickness

Params.thickness - Single

#### Example:

```
Params.thickness = 0.5
Dcad3.Setpoint 0,0,0
Dcad3.Setpoint 40,10,0
Dcad3.Wall Params, True
```

### Zoom Params, ShowCmdLine

Params.zoomFactor - Single ;

Params.zoomStatic - Boolean; if True, changes the internal scale of the drawing. (Should be left at False for most purposes.)

Description: Zoom in or out of the drawing

#### Example:

```
Dcad3.SetPoint 0,0,0
Dcad3.SetPoint 5,0,0
Dcad3.Circle1 Params, False
Params.zoomFactor = 4
Dcad3.SetPoint 5,0,0
Dcad3.Zoom Params, False
```

### ZoomIn

Description: Zoom in by a fixed percentage of the current size

#### Example:

```
Dcad3.Setpoint 10, 10, 0
Dcad3.ZoomIn
```

### ZoomOut

Description: Zoom out by a fixed percentage of the current size

#### Example:

```
Dcad3.Setpoint 10,10, 0
Dcad3.ZoomOut
```

### ZoomPrevious

Description: Zoom back to the previous zoom settings

Example:

```
Dcad3.ZoomPrevious
```

### **ZoomRedo**

Description: Undo the last ZoomPrevious

Example:

```
Dcad3.ZoomRedo
```

### **ZoomWindow**

Description: Enlarge a rectangular portion of the screen

Example:

```
Dcad3.Setpoint 0,0,0
```

```
Dcad3.Setpoint 20, 15, 0
```

```
Dcad3.ZoomWindow
```

This section is devoted to any additions or changes that have occurred in the software since the *DesignCAD 97 Reference Manual* and *User's Guide* were printed.

**Hint:** We've made it easy for you to update the printed documentation. Just jump to the new and updated entries, print a copy and insert them in the appropriate page openings in your manual.

---

## **Additions**

[Animation Mode Command](#)

[AVI Command](#)

[Command Dialog Command](#)

[Continue Recording Command](#)

[Control Panel Command](#)

[Create Walk Through Command](#)

[Hidden Edge Command](#)

[Load Animation Template Command](#)

[Macro Toolbox Command](#)

[Pause Recording Command](#)

[Record Options Command](#)

[Refresh Command](#)

[Run Walk Through Command](#)

[Save Animation Template Command](#)

[Select Previous Command](#)

[Selection Zoom Command](#)

[Send All Open Documents Command](#)

[Send Current Document Command](#)

[Stop Recording Command](#)

[Surface Intersection Command](#)

[Symbol Library Command](#)

[Texture Mapping Command](#)

[Time Line Command](#)

[Tip of the Day Command](#)

[VRML Command](#)

[VRML WWW Anchor Command](#)

## [Weld Command](#)

### Changes

The Cursor Step Size Command is now simply the [Cursor Command](#).

An additional option has been added to the Dimension details portion of the [Info Box Command](#). The new option is Reverse Text Direction.

Some additional options have been added to the [General Options](#). The new options are Save Preview Bitmap With Drawing, Use Single Line Command Dialog, Group Object When Created, Display Drawing Backward, and Numeric Format.

Small yet note-worthy changes have been made to the descriptions of the Display Grid Extent option and Display Grid Plane option. These options are located in the Grid Options folder of the Options file box. Another option, Display Grid Type, has been added to the folder as well. See the [Grid Options](#) entry of this Help file for details.

The [Group Define](#) and [Group Explode](#) Commands have been moved from EDIT|SELECTION to the TOOLS menu.

The Perpendicular-1 Command is now the [Perpendicular to a Line Command](#).

The Perpendicular-2 Command is now the [Perpendicular From a Line Command](#).

The options available in the [Print Command](#) have changed substantially since the printed documentation was sent to press.

The Run BasicCAD Command is now the [Run Executable Command](#).

The Save Selected Command has been incorporated into the [Save As Command](#) as an option of the Save As Dialog Box. There is no longer a "Save Selected Command."

The Snap Grid Size Command is now the [Grid Settings Command](#).

The Solid Subtract Command is now the [Subtract Command](#).

The Tangent-Three Lines Command in the printed documentation should be disregarded. The name has changed to [Circle Tangent to Three Lines Command](#) which appears on page 89 of the *DesignCAD 97 Reference Manual*.

The [Tangent Between Circles Command](#), [Tangent From a Circle Command](#), and [Tangent to a Circle Command](#) all list their menu as LINES. They have been moved to the LINES submenu of the DRAW menu.

In the BasicCAD Statements section, the fifth line of the example for the [GETATTR Statement](#) should be:

```
getattr j, type, group, layr
not
setattr j, type, group, layer
```

Layer is a BasicCAD key word (statement) and cannot be used as a BasicCAD variable.



In the [Document Methods](#) portion of the OLE Automation documentation, the LoadSymbol example (p. 636 of the *DesignCAD 97 Reference Manual*) is incorrect. Last line should be:

```
Dcad3.LoadSymbol Params, False, False
```

**not**

```
Dcad3.LoadSymbol Params, False
```



