



Deskstar 5

DHEA-34330 and DHEA-36480

IBM OEM has introduced a new range of disk drives for the desktop personal computer marketplace.

Available in two capacity points with AT interface, the drives provide excellent performance and reliability.

Applications

- Desktop personal computers
- Entry servers
- Entry workstations



Features

Benefits

● 4.33GB and 6.48GB formatted capacities (512 byte/sector)	● <i>Range of capacities to meet the need for increasing storage requirements</i>
● PIO and DMA data transfer modes <ul style="list-style-type: none"> ● PIO Mode 4 rates up to 16.6MB/sec ● Ultra DMA/33 rates up to 33.3MB/sec 	● <i>Fast interface data rates</i>
● Average seek time 9.1ms (Read) 9.5ms(Write)	● <i>Fast access to data</i>
● 5400 RPM	
● 476KB adaptive sector buffer	● <i>Fast data retrieval in single and multitasking applications</i>
● Industry standard mounting	● <i>Ease of installation</i>
● The drive can be mounted with any of its six surfaces facing down	
● Advanced ECC on the fly (EOF)	● <i>Improved data throughput</i>
● CHS and LBA addressing modes	● <i>Flexibility to support most appropriate addressing</i>
● Power saving modes	● <i>Reduced power consumption</i>
● Robust design for EMC/RFI	● <i>Easy integration across multiple platforms</i>
● MR (Magneto Resistive) head technology	● <i>High area density low component count</i>
● No ID sector format	● <i>More data stored per track, increased sustained data transfer rate</i>
● PRML Data Channel	
● S.M.A.R.T. function support	● <i>High reliability and availability</i>

Connectors

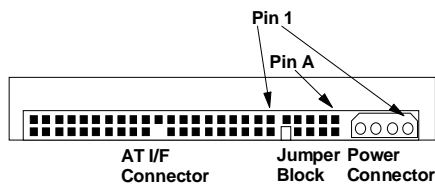

The DC power connector is designed to mate with AMP part 1-480424 (using AMP pins P/N 350078-4). Equivalent connectors may be used. Pin assignments are shown below, viewed from the end of the drive.

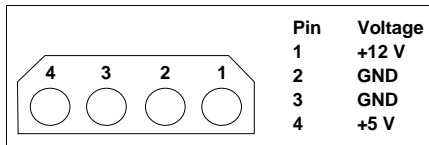

AT I/F Connector

The drive uses single-ended drivers and receivers. The connector is designed to mate with 3M part 3417-7000 or equivalent.

Note: It is intended that the hard disk should only be in electrical contact with the chassis of the PC at a designated set of mounting holes. Other electrical contact may degrade error rate performance. As a result of this it is recommended that there should be no metal contact to the hard disk drive except at the mounting holes or the side rails into which the mounting holes are tapped.



PACKAGING: The drive must be protected against Electrostatic Discharge especially when being handled. The safest way to avoid damage is to put the drive in an anti static bag before ESD wrist straps etc. are removed.

Drives should only be shipped in approved containers, severe damage can be caused to the drive if the packaging does not adequately protect against the shock levels induced when a box is dropped. Consult your IBM marketing representative if you do not have an approved shipping container.

Jumper Block

Jumper Settings

Jumpers may be fitted to select the following options:-

16 head logical architecture

	Pin Numbers
MASTER active	A-B and G-H
SLAVE active	A-B and C-D
Cable sel	E-F
SLAVE Present	E-F and G-H
Reserved	I

15 head logical architecture

	Pin Numbers
MASTER active	A-C and G-H
SLAVE active	A-C
Cable sel	A-C and E-F
SLAVE Present	A-C, E-F and G-H
Reserved	I

All other jumper setting patterns are reserved. **DO NOT MAKE OTHER SETTINGS!**

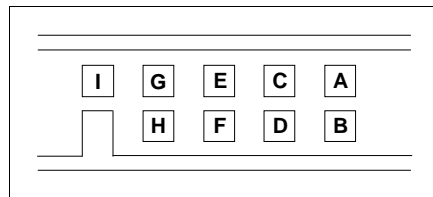

Shipping Default Settings

16 head logical architecture is enabled. MASTER is set to on (i.e. jumper on pins A-B and G-H) No other jumpers are fitted.

Operating Environment

Operating Conditions

Temperature	5° to 55°C*
Relative Humidity	8 to 90% non-condensing
Maximum Wet Bulb Temperature	29.4°C non-condensing
Maximum Temperature Gradient	15°C/Hour
Altitude	-300 to 3048m

Non Operating Conditions

Temperature	-40° to 65°C
Relative Humidity	5 to 95% non-condensing
Maximum Wet Bulb Temperature	35°C non-condensing
Maximum Temperature Gradient	15°C/Hour
Altitude	-300 to 12,000m

Note: * The system is responsible for providing sufficient air movement to maintain surface temperature below 60°C at the centre of the top cover of the drive.

Operating Shock

The hard disk drive meets the following criteria while operating in respective conditions described below. There must be a delay between shock pulses, long enough to allow the drive to complete all necessary error recovery procedure.

No errors	5G, 11 ms half-sine shock pulse
No data loss seek errors or permanent damage	10G, 11ms half-sine shock pulse
No data loss or permanent damage	15G, 5 ms half-sine shock pulse
	30G, 4 ms half-sine shock pulse .

Non-Operating Shock

The drive withstands without damage or degradation of performance, a 75G half-sine wave shock pulse of 11ms duration on six sides when heads are parked. (When power is not applied to the unit the heads are automatically located in the parked position). Above specification is for shocks applied in each direction of the drives three mutually perpendicular axis, one axis at a time.

Operating Vibration

Due to the complexity of this subject we recommend that users contact the IBM technical support group representative to discuss how to perform the necessary measurements if they believe this to be an area which requires evaluation.

DC Power Requirements

The following voltage specifications apply at the drive power connector. Damage to the drive electronics may result if the power supply cable is connected or disconnected while power is being applied to the drive (**Hot plug/unplug is not allowed**). There is no special power on/off sequencing required.

Input Voltage

+5 Volts Supply 5V(+/-5% during run and spin up)¹
 +12 Volts Supply 12V(+10%,-8% during run and spin up)²

¹ To avoid damage to the file electronics 5V power supply voltage spikes must not exceed 7V.

² To avoid damage to the file electronics 12V, power supply voltage spikes must not exceed 15V.

Power Supply Current

(All values in Amps.)	+ 5 volts Pop Mean	+12 volts Pop Mean
Idle average	0.32	0.26
Idle ripple (peak to peak)	0.20	0.48
Seek peak ¹	0.44	1.40
Seek average ¹	0.30	0.50
Start up (max)	0.60	2.00
Random R/W peak ²	0.70	1.40
Random R/W average ²	0.36	0.39
Standby/Sleep average	0.13	0.002

¹ Random Seeks at 40% duty cycle.

² Seek duty = 30%, W/R duty = 45%, Idle duty = 25%.

Power Supply Generated Ripple as seen at file power connector.

	Maximum	Notes
+5V DC	100mV pp	0-10 MHz
+12V DC	150mV pp	0-10 MHz

During file start up and seeking, 12 volt ripple is generated by the file (referred to as dynamic loading). If several files have their power daisy chained together then the power supply ripple plus other file's dynamic loading must remain within the regulation tolerance of +10/-8%. A common supply with separate power leads to each file is a more desirable method of power distribution.

To prevent external electrical noise from interfering with the file's performance, the file must be held by four screws in a user system frame which has no electrical level difference at the four screws position, and has less than +/- 300 millivolts peak to peak level difference to the file power connector ground.

Cabling

The maximum cable length from the Host system to the drive, plus the circuit pattern length inside the Host systems, must not exceed 18 inches (45.7cm).

For higher data transfer application >8.3MB/sec, a consideration in system design is recommended to reduce cable noise and/or cross-talk, such as shorter cable, bus termination, shielded cable, etc.

Signal Definition

The pin assignments of interface signals are listed as follows:

PIN	Signal	I/O	PIN	Signal	I/O
01	-RESET	I	02	GND	
03	DD07	I/O	04	DD08	I/O
05	DD06	I/O	06	DD09	I/O
07	DD05	I/O	08	DD10	I/O
09	DD04	I/O	10	DD11	I/O
11	DD03	I/O	12	DD12	I/O
13	DD02	I/O	14	DD13	I/O
15	DD01	I/O	16	DD14	I/O
17	DD00	I/O	18	DD15	I/O
19	GND		(20)	Key	
21	DMARQ	O	22	GND	
23	-DIOW*	I	24	GND	
25	-DIOR*	I	26	GND	
27	IORDY*	O	28	CSEL	I
29	-DMACK	I	30	GND	
31	INTRQ	O	32	-HIOCS16	O
33	DA01	I	34	-PDIAG	I/O
35	DA00	I	36	DA02	I
37	-CSO	I	38	-CS1	I
39	-DASP	I/O	40	GND	

Note:

"O" designates an output from the Drive.
 "I" designates an input from the Drive.
 "I/O" designates an input/output common.
 "*" These signal lines are redefined during the Ultra DMA protocol to provide special functions as detailed in the table below:-

	Special Definition (Ultra DMA)	Conventional Definition
Write Operation	-DDMARDY -HSTROBE -STOP	IORDY -DIOR -DIOW
Read Operation	-HDMARDY -DSTROBE -STOP	-DIOR IORDY -DIOW

Interface

The interface conforms to the working document of information technology - AT Attachment-3 Interface (ATA-3) revision 6 dated on October 26 1995 with following deviations.

ICRCE (Interface CRC error)

Bit 7 of Error Register is supported as Interface CRC Error bit. This bit will be set if a CRC error has occurred on the data bus during an ULTRA-DMA transfer.

Check Power Mode

CHECK POWER MODE command returns FFh to Sector Count Register when the device is in Idle mode. This command does not support 80h as the return value.

Sleep mode

During Sleep mode the drive will be activated by any command, including, but not limited to, a soft reset.

Hard Reset

Hard Reset response is identical to Soft Reset response with the following exception:

When drive is MASTER the DASP line is not checked and SLAVE presence is assumed to be unchanged. When drive is set as a SLAVE it will activate DASP line to indicate it is present.

Data Organisation

Description	DHEA-34330	DHEA-36480
Physical Layout		
Label Capacity (MB)	4330	6480
Bytes per Sector	512	512
Sectors per Track	132-211	132-211
Number of heads	5	8
Number of disks	3	4
Logical Layout^{1,2}		
Number of Heads	16 (15)	16 (15)
Number of Sectors/Track	63	63
Number of Cylinders	8440 (8960)	12592 (13424)
# of Sectors	8467200 (8467200)	12692736 (12685680)
Total logical Data Bytes	4335206400 (4335206400)	6498680832 (6495068160)

¹ Logical layout describes imaginary HDD parameters which are used to access customer data on the disk drive. Logical layout to Physical layout (i.e.. actual Head, Sector) translation is done automatically in the HDD Default setting can be obtained by issuing IDENTIFY DRIVE command.

² Bracketed values show alternate, jumper selectable, option.

Command Description

The following Commands are supported by the Drive:

Commands	(Hex)	P
Check Power Mode	(E5)	3
Check Power Mode*	(98)	3
Execute Drive Diagnostics	(90)	3
Flush Cache	(E7)	3
Format Track	(50)	2
Identify Drive	(EC)	1
Identify Drive DMA	(EE)	4
Idle	(E3)	3
Idle*	(97)	3
Idle Immediate	(E1)	3
Idle Immediate*	(95)	3

Initialise Drive Parameters	(91)	3
Read Buffer	(E4)	1
Read DMA (retry)	(C8)	4
Read DMA (no retry)	(C9)	4
Read Long (retry)	(22)	1
Read Long (no retry)	(23)	1
Read Multiple	(C4)	1
Read Native Max LBA/CYL	(F8)	3+
Read Sectors (retry)	(20)	1
Read Sectors (no retry)	(21)	1
Read Verify Sectors (retry)	(40)	3
Read Verify Sectors (no retry)	(41)	3
Recalibrate	(1X)	3
Seek	(7X)	3
Set Features	(EF)	3
Set Max LBA/CYL	(F9)	3+
Set Multiple	(C6)	3
Sleep	(E6)	3
Sleep*	(99)	3
SMART Disable Operations	(BO)	3
SMART Enable/Disable Attribute Autosave	(BO)	3
SMART Enable Operations	(BO)	3
SMART Execute Off-line Data Collection	(BO)	3
SMART Read Attribute Values	(BO)	1
SMART Read Attribute Thresholds	(BO)	1
SMART Return Status	(BO)	3
SMART Save Attribute Values	(BO)	3
Standby	(E2)	3
Standby*	(96)	3
Standby Immediate	(EO)	3
Standby Immediate*	(94)	3
Write Buffer	(E8)	2
Write DMA (retry)	(CA)	4
Write DMA (no retry)	(CB)	4
Write Long (retry)	(32)	2
Write Long (no retry)	(33)	2
Write Multiple	(C5)	2
Write Sectors (retry)	(30)	2
Write Sectors (no retry)	(31)	2

P(protocol):

- 1 PIO data IN command
 - 2 PIO data OUT command
 - 3 Non data command
 - 4 DMA command
- + Vendor specific command

* Alternate command codes for previous defined commands.

Electromagnetic Compatibility

The drive meets the following EMC requirements when installed in a suitable user system and exercised with a random accessing routine at maximum data rate:

United States Federal Communication Commission (FCC) Rules and Regulations Part 15, subject J - Computer Devices "Class B Limits".

European Economic Community (ECC) directive #76/889 related to the control of radio frequency interference and the Verband Deutscher Elektrotechniker (VDE) requirements of Germany (GOP).

Council Directive 89/336/EEC on the approximation of laws of the Member States relating to electromagnetic compatibility.

Registers (Primary Channel Addresses)

Address	Input Register	Output Register
1F0h	Data	Data
1F1h	Error	Features
1F2h	Sector Count	Sector Count
1F3h	Sector Number *LBA bits 0-7	Sector Number *LBA bits 0-7
1F4h	Cylinder Low *LBA bits 8-15	Cylinder Low *LBA bits 8-15
1F5h	Cylinder High *LBA bits 16-23	Cylinder High *LBA bits 16-23
1F6h	Drive/Head *LBA bits 24-27	Drive/Head *LBA bits 24-27
1F7h	Status	Command
3F6h	Alternate Status	Device Control
3F7h	Drive Address	Not Used

The host uses the register interface to communicate to and from the drive. The registers are accessed through the host port addresses shown. The host should not read or write any registers when the Status Register BSY bit = 1.

Note: * Meaning of Register contents when LBA addressing mode used.

Mechanical Data

Dimensions

Height	25.4 +/- 0.4mm
Width	101.6 +/- 0.4mm
Length	146.0 +/- 0.6mm
Weight	580g maximum

Outline Dimensions

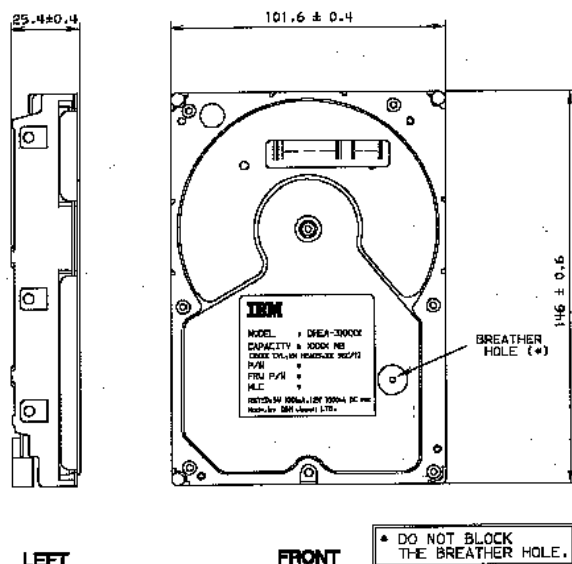

Mounting Holes

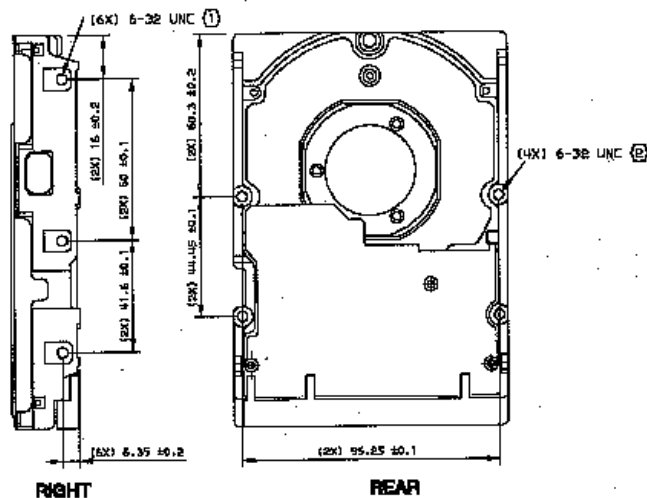

The recommended mounting screw torque is 0.6-1.0(NM) (6-10[Kgf.cm]).

- 1 Max allowable penetration of noted screw to be 3.5mm
- 2 Max allowable penetration of noted screw to be 5.5mm.

Connector Locations

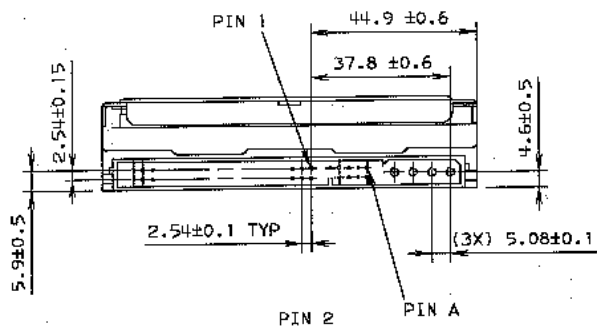

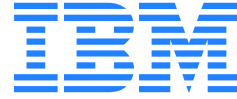

IBM OEM Europe

PO Box 41
North Harbour
Portsmouth
Hampshire
PO6 3AU
United Kingdom
Telephone: (44) 1705 561000

IBM Corporation

Storage Systems Division
5600 Cottle Road
San Jose, CA 95193
(408) 256-8000

Japan Headquarters: (81) 466-45-1384

Asia-Pacific Headquarters: (65) 320-1503

Internet access at:
<http://www.storage.ibm.com/storage/oem/menu1.htm>

Registered in England: No. 741598
Registered Office: PO Box 41, North Harbour,
Portsmouth, Hampshire PO6 3AU.

UK company-wide registration to ISO90001.
Certificate number FM12587.

IBM is the registered trademark of International
Business Machines Corporation.

AMP is a trademark of AMP Incorporated
Molex is a trademark of Molex Incorporated
DATA MATE is a trademark of AMP Incorporated

Other company, product and service names may be
trademarks or service marks of others.

Produced by European SIT Lab.

© International Business Machines Corporation 1997.

This data sheet is not a substitute for the full
production specification, which should be used when
detailed information is required.

Product Description data represents IBM's design
objectives and is provided for comparative purposes;
actual results may vary based on a variety of factors.
This product data does not constitute a warranty.
Questions regarding IBM's warranty terms or
methodology used to derive this data should be
referred to your IBM OEM representative. Data
subject to change without notice.

Date: 20 May 1997

Distributor: